



Front colours



No. 777 cosmos grey matt



No. 793 noble white matt



No. 722 polar white hgl.



No. 891 quarz grey matt



No. 893 titanium grey matt



no. 751 Cuneo oak brown



no. 771 Cuneo oak natural



no. 794 sand oak

F foiled front

M Melamine coated front with ABS-edge

carcass colours

* High gloss carcass for an additional price



No. 177 cosmos grey matt

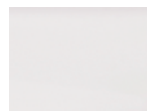

No. 111 white matt

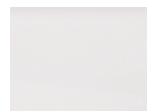

*no. 161 white hgl.



no. 191 quarz grey matt



No. 193 titanium grey matt



no. 151 Cuneo oak brown



no. 171 Cuneo oak natural



no. 194 sand oak

Washbasin plates and top covers colours



No. 177
cosmos grey matt

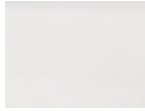

No. 111
white matt



no. 191
quarz grey
matt



No. 193
titanium grey
matt



no. 151
Cuneo oak brown



no. 171 Cuneo oak
natural



no. 194
sand oak



no. 174
Hunton oak



No. 143
Slate imitation

Accent decors for plug-in shelf



no. 501
white matt lacquered



no. 547
black matt lacquered

Washbasin colours

Cast mineral top washbasin



no. 1
white
available in 2 different
sizes

Ceramic counter top washbasin

Squared



no. 1
white
available in 2 different
sizes

Squared



No. 43
Carbone
available in 2 different
sizes

Handle versions



No. 329
Strip handle chrome
handle lenght 194 mm / 294 mm
/ 494 mmm



no. 338
Strip handle aluminium matt
handle lenght 194 mm / 294 mm
/ 494 mmm



No. 339
Strip handle black matt
handle lenght 194 mm / 294 mm
/ 494 mmm

Technique

door with integrated buffered closing









Pull outs and drawers

No. 554

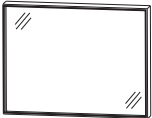
Illustrations and specifications are without obligation. Technical modifications reserved.
2022/2023







Please note the instruction for warranty, mounting and care, and the quality agreements as well, at the beginning of the book.

Program 066 - type list

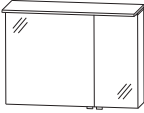
| Depth indication corresponds to the carcass depth | | Depth in mm | Width in mm | Height in mm | Article number | Hinge | Surchar- ge high- gloss carcass |
|---|--|----------------|----------------|-----------------|--|-------|--|
| Mirrors | | | | | | | |
|   | Mirror LED aluminium frame all-round LED lighting 37,2 watt / converter 60 watt 3497 lumens / 2700 - 6500 Kelvin Emotion lighting This product contains a light source with energy efficiency class: F | | | | | | |
| | aluminium frame in black matt anodize aluminium fram in white matt lacquered | 40 40 | 600 600 | 640 640 | F S B 4 5 6 0 0 4 F S B 4 5 6 0 0 5 | | |
|   | Mirror LED aluminium frame all-round LED lighting 46,5 watt / converter 60 watt 4371 lumens / 2700 - 6500 Kelvin Emotion lighting This product contains a light source with energy efficiency class: F | | | | | | |
| | aluminium frame in black matt anodize aluminium fram in white matt lacquered | 40 40 | 900 900 | 640 640 | F S B 4 5 9 0 0 4 F S B 4 5 9 0 0 5 | | |
|   | Mirror LED aluminium frame all-round LED lighting 55,8 watt / converter 60 watt 5245 lumens / 2700 - 6500 Kelvin Emotion lighting This product contains a light source with energy efficiency class: F | | | | | | |
| | aluminium frame in black matt anodize aluminium fram in white matt lacquered | 40 40 | 1200 1200 | 640 640 | F S B 4 5 1 2 0 4 F S B 4 5 1 2 0 5 | | |
| Mirror cabinets | | | | | | | |
|   Ill. = left | mirror cabinet 1 double mirror door 2 glass shelves 1 LED panel light (8,6 watt) 699 lumens / (2700 -) 6500 Kelvin 1 LED converter 15 W 1 switch socket element Door width: 596 mm This product contains a light source with energy efficiency class: F | 150 | 600 | 660 | A S P 4 1 6 0 0 1 | L/R | |
| | Additional accessories LED washbasin lighting LED washbasin lighting emotion Emotion lighting | | | | P Z 1 0 6 3 60 P Z 1 1 5 0 60 P Z 1 0 2 0 1 | | |

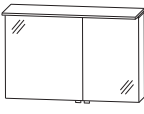

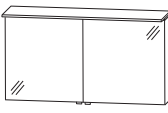

Please observe suitable accessories in the separate index.

Program 066 - type list

| Depth indication corresponds to the carcass depth | | Depth in mm | Width in mm | Height in mm | Article number | Hinge | Surcharge high-gloss carcass |
|---|--|----------------|----------------|-----------------|---|-------|------------------------------|
|  <p>mirror cabinet 2 double mirror doors 2 glass shelves 1 LED panel light (13,2 watt) 1082 lumens / (2700 -) 6500 Kelvin 1 LED converter 30 W 1 switch socket element Door width: 596 mm / 296 mm This product contains a light source with energy efficiency class: F</p> <p>Additional accessories LED washbasin lighting LED washbasin lighting emotion Emotion lighting</p> | | 150 | 900 | 660 | ASP 4 2 9 0 0 1 | L/R | |
|  <p>III. = right</p> | | | | | P Z 1 0 6 3 9 0 P Z 1 1 5 0 9 0 P Z 1 0 2 0 1 | | |
|  <p>mirror cabinet 2 double mirror doors 1 central partition, 4 glass shelves 1 LED panel light (14,8 watt) 1208 lumens / (2700 -) 6500 Kelvin 1 LED converter 30 W 1 switch socket element Door width: 596 mm / 396 mm This product contains a light source with energy efficiency class: F</p> <p>Additional accessories LED washbasin lighting LED washbasin lighting emotion Emotion lighting</p> | | 150 | 1000 | 660 | ASP 4 2 1 0 0 1 | L/R | |
|  <p>III. = right</p> | | | | | P Z 1 0 6 3 9 0 P Z 1 1 5 0 9 0 P Z 1 0 2 0 1 | | |
|  <p>mirror cabinet 2 double mirror doors 1 central partition, 4 glass shelves 1 LED panel light (17,8 watt) 1462 lumens / (2700 -) 6500 Kelvin 1 LED converter 30 W 1 switch socket element Door width: 596 mm / 596 mm This product contains a light source with energy efficiency class: F</p> <p>Additional accessories LED washbasin lighting LED washbasin lighting emotion Emotion lighting</p> | | 150 | 1200 | 660 | ASP 4 2 1 2 0 1 | | |
|  | | | | | P Z 1 0 6 3 1 2 P Z 1 1 5 0 1 2 P Z 1 0 2 0 1 | | |

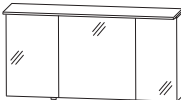

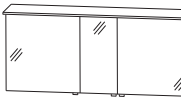



Please observe suitable accessories in the separate index.

Program 066 - type list

| Depth indication corresponds to the carcass depth | Depth in mm | Width in mm | Height in mm | Article number | Hinge | Surcharge high-gloss carcass |
|---|-------------|-------------|--------------|-------------------|-------|------------------------------|
| <p>Mirror cabinets</p>  <p>Mirror cabinet- Set electrical connections for mirror cabinets 900 mm wide 2 double mirror doors 2 glass shelves electrical connections for mirror cabinets 400 mm wide 1 double mirror door, 2 glass shelves 1 LED panel light (19,38 watt) 1589 lumens / (2700 -) 6500 Kelvin 1 LED converter 30 W 2 switch-socket elements Door width: 396 mm / 596 mm / 296 mm This product contains a light source with energy efficiency class: F</p> <p>Additional accessories LED washbasin lighting LED washbasin lighting emotion Emotion lighting</p> <p>III. = left larger door left</p>  | 150 | 1300 | 660 | A S P 4 3 1 3 0 1 | L/R | |
|  <p>Mirror cabinet- Set electrical connections for mirror cabinets 900 mm wide 2 double mirror doors 2 glass shelves electrical connections for mirror cabinets 600 mm wide 1 double mirror door 2 glass shelves 1 LED panel light (22,5 watt) 1843 lumens / (2700 -) 6500 Kelvin 1 LED converter 30 W 2 switch-socket elements Door width: 596 mm / 296 mm / 596 mm This product contains a light source with energy efficiency class: F</p> <p>Additional accessories LED washbasin lighting LED washbasin lighting LED washbasin lighting emotion LED washbasin lighting emotion Emotion lighting</p> <p>III. = left choose the hinge of the middle-door</p>  | 150 | 1500 | 660 | A S P 4 3 1 5 0 1 | L/R | |

Please observe suitable accessories in the separate index.



Program 066 - type list

| Depth indication corresponds to the carcass depth | | Depth in mm | Width in mm | Height in mm | Article number | | | Hinge | Surchar- ge high- gloss carcass |
|--|---|----------------|----------------|-----------------|-----------------|----------|---|-------|--|
| topcover washbasin | | | | | | | | | |
|   | cast mineral - topcover washbasin white incl. permanent drain incl. tap hole 490 mm wide | 423 | 490 | 60 | WTAS1111 | 1 | | | |
| | Matching washstand cutout 600 mm wide Matching washstand cutout | | | | | | | | |
| | Additional accessories CLOU drain and overflow system Surcharge for washbasins without tap-hole or with 3 holes (according to sketch) | | | | PZ | 1 1 0 9 | 1 | | |
|   | Ceramic counter top washbasin Squared incl. permanent drain incl. tap hole ceramic counter too white | 450 | 500 | 125 | WTM4805 | 1 | | | |
| | ceramic counter too Carbone matt Matching washstand cutout | | | | | | | | |
| | Additional accessories CLOU drain and overflow system | | | | PZ | 1 1 0 9 | 1 | | |
|   | Ceramic counter top washbasin Squared incl. permanent drain incl. tap hole ceramic counter too white | 450 | 620 | 125 | WTM4806 | 1 | | | |
| | ceramic counter too Carbone matt | | | | | | | | |
| | CLOU drain and overflow system | | | | PZ | 1 1 0 9 | 1 | | |

You find information on the the washbasin manufacturer at the beginning of the sales book.



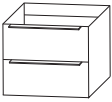

***Delivery time: 8 weeks. Price per washbasin. Washbasin without tap hole is incompatible with CLOU System. Please check your order confirmation for correctness.**

Program 066 - type list

| Depth indication corresponds to the carcass depth | | Depth in mm | Width in mm | Height in mm | Article number | Hinge | Surcharge high-gloss carcass |
|---|--|-------------|-------------|--------------|--|-------|------------------------------|
| Washbasin plates | | | | | | | |
|  | <p>Washbasin plates with ABS edge by use of side doublings plate is 40 mm larger</p> <p>606 mm width</p> <p>646 mm width for side doublings</p> <p>906 mm width</p> <p>946 mm width for side doublings</p> <p>1006 mm wide</p> <p>1046 mm width for side doublings</p> <p>1206 mm width</p> <p>1246 mm width for side doublings</p> <p>1306 mm wide</p> <p>1346 mm width for side doublings</p> <p>1506 mm width</p> <p>1546 mm width for side doublings</p> <p>Please note the additional price for washbasin cutouts.</p> | 495 | 606 | 28 | A P 5 0 6 0 6 6 | | |
| | | 495 | 646 | 28 | A P 5 0 6 4 6 6 | | |
| | | 495 | 906 | 28 | A P 5 0 9 0 6 6 | | |
| | | 495 | 946 | 28 | A P 5 0 9 4 6 6 | | |
| | | 495 | 1006 | 28 | A P 5 0 1 0 6 6 | | |
| | | 495 | 1046 | 28 | A P 5 1 0 4 6 6 | | |
| | | 495 | 1206 | 28 | A P 5 0 1 2 6 6 | | |
| | | 495 | 1246 | 28 | A P 5 1 2 4 6 6 | | |
| | | 495 | 1306 | 28 | A P 5 0 1 3 6 6 | | |
| | | 495 | 1346 | 28 | A P 5 1 3 4 6 6 | | |
| | | 495 | 1506 | 28 | A P 5 0 1 5 6 6 | | |
| | | 495 | 1546 | 28 | A P 5 1 5 4 6 6 | | |
| Washbasin base units | | | | | | | |
|  | <p>Washbasin base unit 1 metal pull out unit with buffered closing 1 aluminium-coloured plastic insert 1 metal pull-out with buffered closing,</p> <p>Additional accessories Space-saving drain stench trap DN 40 Space-saving drain stench trap DN 32</p> | 470 470 | 600 900 | 480 480 | W U A 3 3 6 0 P 3 W U A 3 3 9 0 P 3 | | |
| | | | | | P Z 1 3 6 7 P Z 1 4 2 3 | | |
|  | <p>Washbasin base unit 1 metal pull out unit with buffered closing 1 aluminium-coloured plastic insert 1 push-back shelf</p> <p>please note the accent decor for plug-in shelf no. 501 white matt lacquered no. 547 black matt lacquered</p> <p>Additional accessories Space-saving drain stench trap DN 40 Space-saving drain stench trap DN 32</p> | 470 | 600 | 480 | W U A 3 2 6 E P 3 | | |
| | | | | | P Z 1 3 6 7 P Z 1 4 2 3 | | |

Please observe suitable accessories in the separate index.

Program 066 - type list

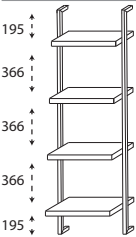
| Depth indication corresponds to the carcass depth | | Depth in mm | Width in mm | Height in mm | Article number | Hinge | Surcharge high-gloss carcass |
|--|--|-------------|-------------|--------------|--------------------------|-------|------------------------------|
| Base units for washbasin plates | | | | | | | |
|  | washbasin base unit 2 metal pull-outs with buffered closing | 470 | 300 | 480 | U T A 3 3 3 0 R G | | |
| | | 470 | 400 | 480 | U T A 3 3 4 0 R G | | |
| | | 470 | 600 | 480 | U T A 3 3 6 0 R G | | |
|  | washbasin base unit 1 push-back shelf above 1 metal pull-out with buffered closing | 470 | 300 | 480 | U T A 3 7 3 A 0 1 | | |
| | | 470 | 400 | 480 | U T A 3 7 4 A 0 1 | | |
| | | 470 | 600 | 480 | U T A 3 7 6 A 0 1 | | |
| please note the accent decor for plug-in shelf no. 501 white matt lacquered no. 547 black matt lacquered | | | | | | | |
|  | washbasin base unit 1 metal pull-out with buffered closing 1 push-back shelf below | 470 | 300 | 480 | U T A 3 7 3 A 0 2 | | |
| | | 470 | 400 | 480 | U T A 3 7 4 A 0 2 | | |
| | | 470 | 600 | 480 | U T A 3 7 6 A 0 2 | | |
| please note the accent decor for plug-in shelf no. 501 white matt lacquered no. 547 black matt lacquered | | | | | | | |
| Side doublings for washbasin, & plate-base-units | | | | | | | |
|  | side doubling metal frame for washbasin base units and base units for washbasin plates in black matt with 1 carcass-panel Please state the carcass colour Price per item | 489 | 19 | 776 | S D H 4 9 7 8 0 1 | | |
| System shelf | | | | | | | |
|  | System shelf metal frame in black matt 4 fixed wooden shelves Depth: 200 mm, 240 mm, 280 mm, 320 mm variable in width Width from both outer edges of the frame | 320 | 300-600 | 1600 | R G M 1 6 0 V 0 1 | | |

Please observe suitable accessories in the separate index.

Program 066 - type list

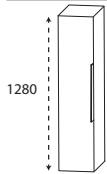
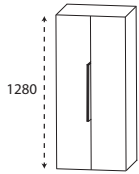
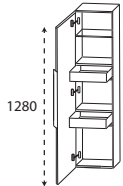
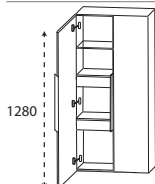
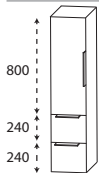
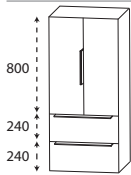
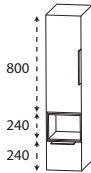

Depth indication corresponds to the carcass depth

Central units
top cover has to be ordered separately

| | Depth in mm | Width in mm | Height in mm | Article number | Hinge | Surcharge high-gloss carcass |
|---|-------------|-------------|--------------|--|-------|------------------------------|
|  | 300 | 300 | 1280 | MNA8130RG | L/R | |
| | 300 | 400 | 1280 | MNA8140RG | L/R | |
|  | 300 | 600 | 1280 | MNA8160RG | | |
|  | 300 | 300 | 1280 | MNA8430RG | L/R | |
| | 300 | 400 | 1280 | MNA8440RG | L/R | |
|  | 300 | 600 | 1280 | MNA8460RG | | |
|  | 300 | 300 | 1280 | MNA8730RG | L/R | |
| | 300 | 400 | 1280 | MNA8740RG | L/R | |
|  | 300 | 600 | 1280 | MNA8760RG | | |
|  | 300 | 300 | 1280 | MNS8230RG | L/R | |
| | 300 | 400 | 1280 | MNS8240RG | L/R | |
| | | | | please note the accent decor for plug-in shelf no. 501 white matt lacquered no. 547 black matt lacquered | | |

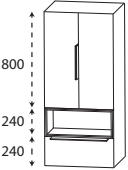
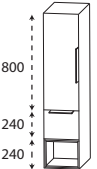
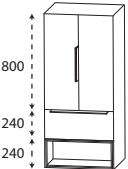

Please observe suitable accessories in the separate index.

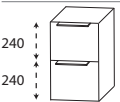
Program 066 - type list

| Depth indication corresponds to the carcass depth | | Depth in mm | Width in mm | Height in mm | Article number | Hinge | Surchar- ge high- gloss carcass |
|--|--|-------------------|-------------------|-------------------|--|------------|--|
| Central units top cover has to be ordered separately | | | | | | | |
|  | medium-high unit 2 doors 2 glass shelves 1 push-back shelf central 1 metal pull-out with buffered closing please note the accent decor for plug-in shelf no. 501 white matt lacquered no. 547 black matt lacquered | 300 | 600 | 1280 | MNS 8 2 6 0 R G | | |
|  | medium-high unit 1 door 2 glass shelves 1 metal pull-out with buffered closing 1 push-back shelf below please note the accent decor for plug-in shelf no. 501 white matt lacquered no. 547 black matt lacquered | 300 300 | 300 400 | 1280 1280 | MNS 8 2 3 1 R G MNS 8 2 4 1 R G | L/R L/R | |
|  | medium-high unit 2 doors 2 glass shelves 1 metal pull-out with buffered closing 1 push-back shelf below please note the accent decor for plug-in shelf no. 501 white matt lacquered no. 547 black matt lacquered | 300 | 600 | 1280 | MNS 8 2 6 1 R G | | |
| Side doublings for central units | | | | | | | |
|  | side doubling metal frame for wall-units in black matt with 1 carcass-panel Please state the carcass colour Price per item | 319 | 19 | 1575 | SDH 3 2 1 2 0 1 | | |
| Base units top cover has to be ordered separately | | | | | | | |
|  | Base unit 2 metal pull-outs with buffered closing | 300 300 300 | 300 400 600 | 480 480 480 | UNA 3 3 3 0 R G UNA 3 3 4 0 R G UNA 3 3 6 0 R G | | |

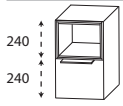
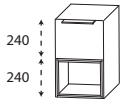

Please observe suitable accessories in the separate index.

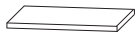
Program 066 - type list

| Depth indication corresponds to the carcass depth | | Depth in mm | Width in mm | Height in mm | Article number | Hinge | Surcharge high-gloss carcass |
|--|--|-------------|-------------|--------------|------------------------|-------|------------------------------|
| Base units | | | | | | | |
| top cover has to be ordered separately | | | | | | | |
|  | Base unit 1 push-back shelf above 1 metal pull-out with buffered closing | 300 | 300 | 480 | UNS 3 2 3 0 R G | | |
| | | 300 | 400 | 480 | UNS 3 2 4 0 R G | | |
| | | 300 | 600 | 480 | UNS 3 2 6 0 R G | | |
| please note the accent decor for plug-in shelf no. 501 white matt lacquered no. 547 black matt lacquered | | | | | | | |
|  | Base unit 1 metal pull-out with buffered closing 1 push-back shelf below | 300 | 300 | 480 | UNS 3 2 3 1 R G | | |
| | | 300 | 400 | 480 | UNS 3 2 4 1 R G | | |
| | | 300 | 600 | 480 | UNS 3 2 6 1 R G | | |
| please note the accent decor for plug-in shelf no. 501 white matt lacquered no. 547 black matt lacquered | | | | | | | |
| Side doublings for wall units | | | | | | | |
|  | side doubling metal frame for base units in black matt with 1 carcass-panel Please state the carcass colour Price per item | 319 | 19 | 775 | SDH 3 2 7 8 0 1 | | |
| Counter tops | | | | | | | |
|  | shelves for base units and central units with ABS edge by use of side doublings plate is 40 mm larger | | | | | | |
| | 302 mm width | 330 | 302 | 28 | APN 3 3 3 0 6 6 | | |
| | 342 mm width with side doublings | 330 | 342 | 28 | APN 3 3 3 4 6 6 | | |
| | 402 mm width | 330 | 402 | 28 | APN 3 3 4 0 6 6 | | |
| | 442 mm width with side doublings | 330 | 442 | 28 | APN 3 3 4 4 6 6 | | |
| | 602 mm width | 330 | 602 | 28 | APN 3 3 6 0 6 6 | | |
| | 642 mm width with side doublings | 330 | 642 | 28 | APN 3 3 6 4 6 6 | | |

Please observe suitable accessories in the separate index.

Program 066 - type list

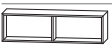
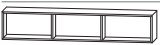
| Depth indication corresponds to the carcass depth | | Depth in mm | Width in mm | Height in mm | Article number | Hinge | Surchar- ge high- gloss carcass |
|--|---|----------------|----------------|-----------------|------------------------|-------|--|
| Glass shelves | | | | | | | |
|  | Glass shelf incl. metal holder | | | | | | |
| | 400 mm wide incl. 2 metal brackets | 130 | 400 | 8 | ABG 1 3 4 0 0 8 | | |
| | 600 mm wide incl. 2 metal brackets | 130 | 600 | 8 | ABG 1 3 6 0 0 8 | | |
| | 900 mm wide incl. 3 metal brackets | 130 | 900 | 8 | ABG 1 3 9 0 0 8 | | |
| | 1000 mm wide incl. 3 metal brackets | 130 | 1000 | 8 | ABG 1 3 1 0 0 8 | | |
| | 1200 mm wide incl. 3 metal brackets | 130 | 1200 | 8 | ABG 1 3 1 2 0 8 | | |
| Shelves | | | | | | | |
|  | functional shelf Edges are cut with a mitre vertical and horizontal mounting possible please indicate colour version: no. 501 white matt lacquered no. 547 black matt lacquered | 150 | 300 | 160 | RGL 1 1 3 0 0 1 | | |
|  | functional shelf Edges are cut with a mitre vertical and horizontal mounting possible please indicate colour version: no. 501 white matt lacquered no. 547 black matt lacquered | 150 | 600 | 160 | RGL 1 1 6 0 0 2 | | |
|  | functional shelf Edges are cut with a mitre vertical and horizontal mounting possible please indicate colour version: no. 501 white matt lacquered no. 547 black matt lacquered | 150 | 900 | 160 | RGL 1 1 9 0 0 3 | | |

Please observe suitable accessories in the separate index.

Programm 066 - examples

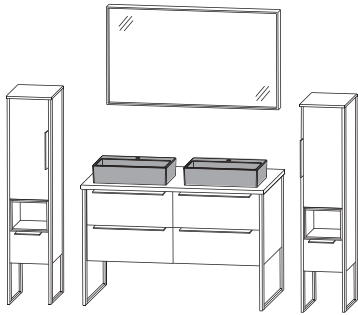
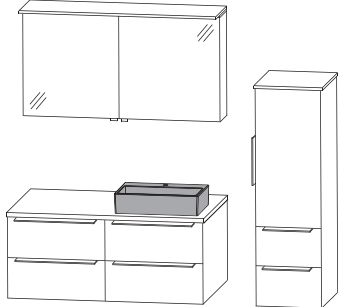
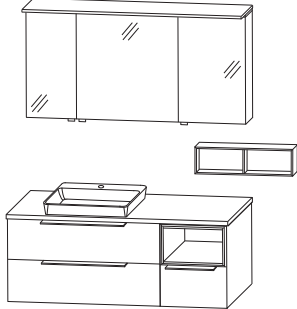
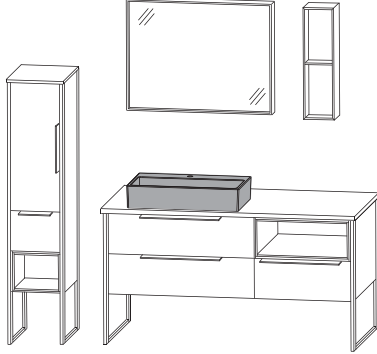
| | | |
|---|--------------------------------------|---|
| ASK-4312-1 | |  |
| 1 Mirror | F S B 4 5 1 2 0 4 | |
| 2 Ceramic counter top washbasin Squared washbasin plate | W T M 4 8 0 5 4 3 A P 5 1 2 4 6 6 | |
| 2 cut- out left and right | A U S 4 8 0 5 2 8 | |
| 2 Washbasin base units | W U A 3 3 6 0 P 3 | |
| 2 side doubling | S D H 4 9 7 8 0 1 | |
| 2 Central units | M N S 8 2 3 0 R G | |
| 2 plates | A P N 3 3 3 4 6 6 | |
| 4 side doubling | S D H 3 2 1 2 0 1 | |
| | | 1200 mm wide + 2 x 300 mm wide |
| ASK-4312-2 | |  |
| 1 mirror cabinet | A S P 4 2 1 2 0 1 | |
| 1 Ceramic counter top washbasin Squared washbasin plate | W T M 4 8 0 5 4 3 A P 5 0 1 2 6 6 | |
| 1 cut- out right | A U S 4 8 0 5 2 8 | |
| 1 Washbasin base units | W U A 3 3 6 0 P 3 | |
| 1 Base unit | U T A 3 3 6 0 R G | |
| 1 medium-high unit | M N A 8 7 4 0 R G | |
| 1 plate | A P N 3 3 4 0 6 6 | |
| | | 1200 mm wide + 400 mm wide |
| ASK-0113-1 | |  |
| 1 mirror cabinet | A S P 4 3 1 3 0 1 | |
| 1 functional shelf | R G L 1 1 6 0 0 2 | |
| 1 cast mineral - topcover washbasin | W T A S 1 1 2 1 | |
| 1 washbasin plate | A P 5 0 1 3 6 6 | |
| 1 cut-out left | A U S S 1 1 2 2 8 | |
| 1 Washbasin base unit | W U A 3 3 9 0 P 3 | |
| 1 Base unit | U T A 3 7 4 A 0 1 | |
| | | 1300 mm wide |
| ASK-4315-1 | |  |
| 1 Mirror | F S B 4 5 9 0 0 4 | |
| 1 functional shelf | R G L 1 1 6 0 0 2 | |
| 1 Ceramic counter top washbasin Squared washbasin plate | W T M 4 8 0 6 4 3 A P 5 1 5 4 6 6 | |
| 1 cut-out left | A U S 1 1 0 2 2 8 | |
| 1 Washbasin base unit | W U A 3 3 9 0 P 3 | |
| 1 Base unit | U T A 3 7 6 A 0 1 | |
| 2 side doubling | S D H 4 9 7 8 0 1 | |
| 1 medium-high unit | M N S 8 2 3 1 R G | |
| 1 plate | A P N 3 3 3 4 6 6 | |
| 2 side doubling | S D H 3 2 1 2 0 1 | |
| | | 1500 mm wide + 300 mm wide |

Program 066 - dimensional drawings

WTA S111 1 + WUA 3360 P3 +
2x SDH 4978 01

WTA S112 1 + WUA 3390 P3 +
2x SDH 4978 01

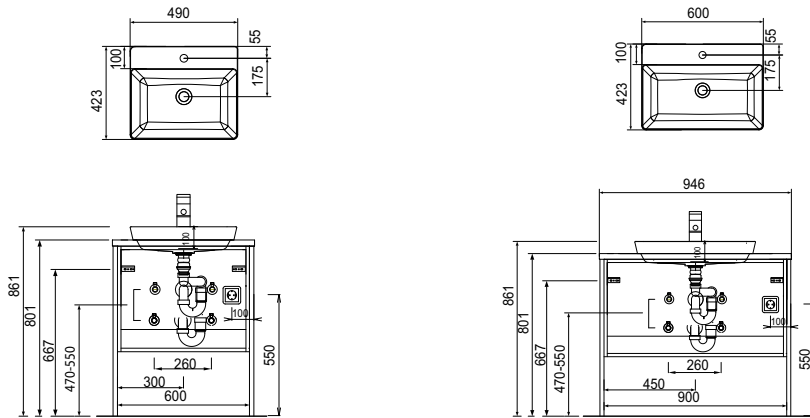

2x WTA S111 1 + 2x WUA 3360 P3 +
2x SDH 4978 01

WTM 4805 + WUA 3360 P3 +
2x SDH 4978 01

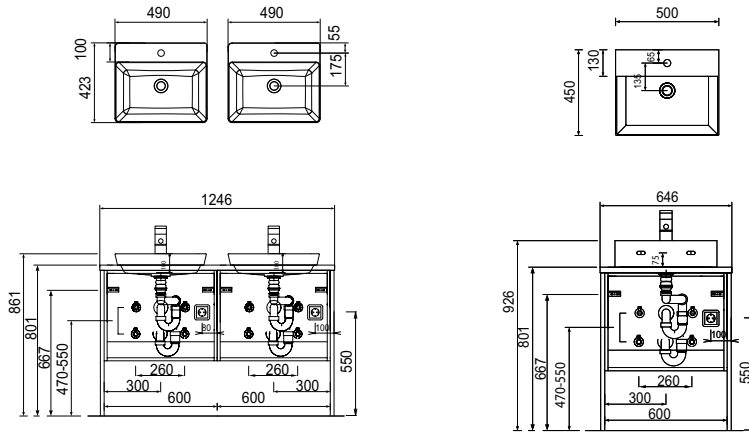

WTM 4806 + WUA 3390 P3 +
2x SDH 4978 01

2x WTM 4805 + 2x WUA 3360 P3 +
2x SDH 4978 01

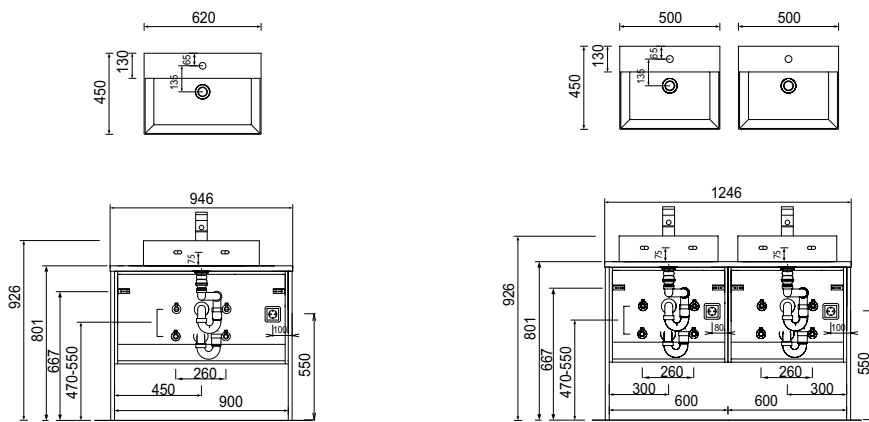

Modifications:

Technical modifications (+/- 5mm) and flatness modifications (DIN 18202) are subject of the usual material-specific modifications for construction materials, based on DIN 18202.

Program 066 - dimensional drawings

WTA S111 1 + WUA 3360 P3

WTA S112 1 + WUA 3390 P3

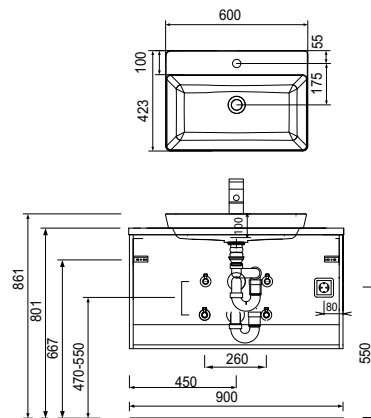
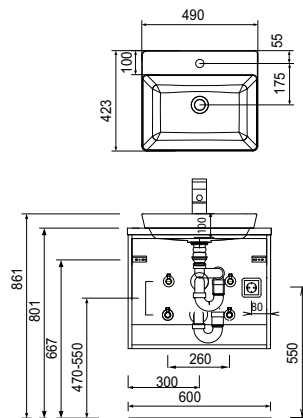

2x WTA S111 1 + 2x WUA 3360 P3

WTM 4805 + WUA 3360 P3

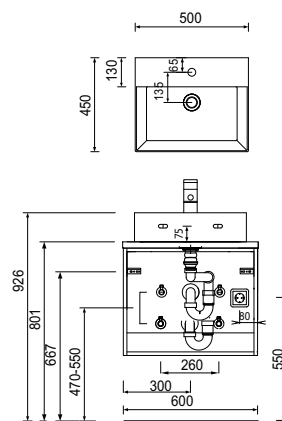
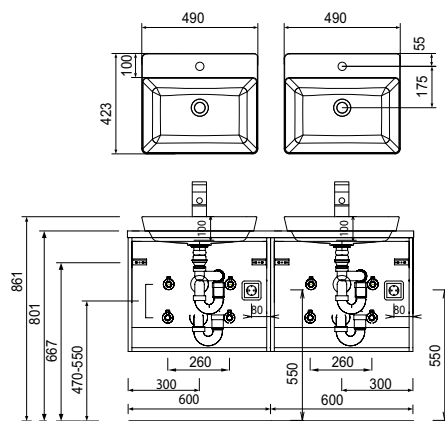

WTM 4806 + WUA 3390 P3

2x WTM 4805 + 2x WUA 3360 P3

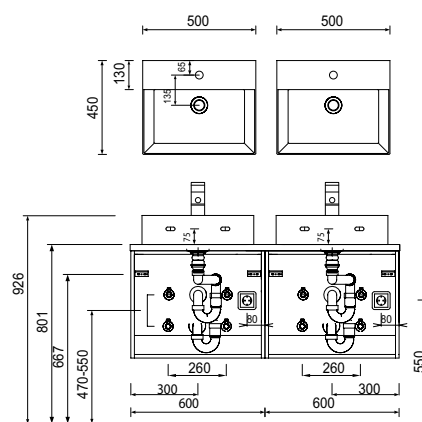
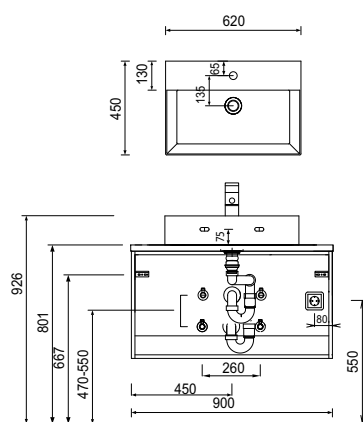

Modifications:

Technical modifications (+/- 5mm) and flatness modifications (DIN 18202) are subject of the usual material-specific modifications for construction materials, based on DIN 18202.

Program 066 - dimensional drawings

electrical connections for mirror cabinets

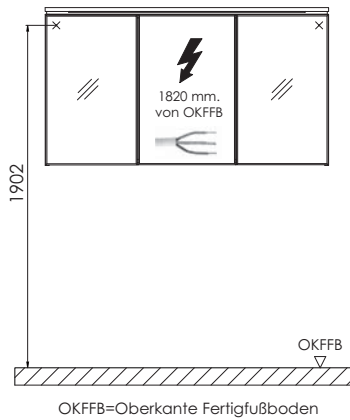

OKFFB=Oberkante Fertigfußboden

Modifications:

Technical modifications (+/- 5mm) and flatness modifications (DIN 18202) are subject of the usual material-specific modifications for construction materials, based on DIN 18202.