



Front colours



No. 777 cosmos grey matt



No. 893 titanium grey matt



No. 722 polar white hgl.



No. 686 anthracite hgl.



Nr. 785 natural oak



no. 776 Charleston oak dark

F foiled front

carcass colours

* High gloss carcass for an additional price



No. 177 cosmos grey matt



No. 193 titanium grey matt

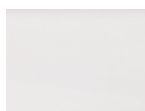

*no. 161 white hgl.



*no. 121 anthracite hgl.



Nr. 185 natural oak

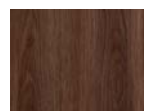

no. 176 Charleston oak dark

Handle version



No. 690 bar handle chrome

handle-borehole distance for straight fronts: 96 mm / 384 mm

Washbasin colours

STONEPLUS washbasins



No. 61 white

Technique

door with integrated buffered closing

No. 554

Pull outs and drawers with soft close

optional:

No. 555







pull-out units and drawer with chrome edge

Illustrations and specifications are without obligation. Technical modifications reserved.

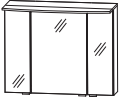





2022/2023 - ID

Please note the instruction for warranty, mounting and care, and the quality agreements as well, at the beginning of the book.



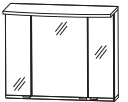

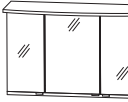
b - bright - model list

| Depth indication corresponds to the carcass depth | | Depth in mm | Width in mm | Height in mm | Article number | | | Hinge | | | |
|---|--|----------------|----------------|-----------------|----------------|--------------------|--|-------|--|--|--|
|   incl. handle blocks | | 150 | 800 | 660 | S 2 A | 4 3 8 0 8 7 | | | | | |
| mirror cabinet 3 double mirror doors 2 central partitions, 6 glass shelves 1 LED panel light round 11,6 watt / Converter 30 watt 954 lumens / (2700 -) 6500 Kelvin 1 switch socket element Door width: 196 mm / 396 mm / 196 mm This product contains a light source with energy efficiency class: F Additional accessories LED washbasin lighting LED washbasin lighting emotion Emotion lighting | | | | | | | | | | | |
| | | | | | P Z | 1 0 6 3 6 0 | | | | | |
| | | | | | P Z | 1 1 5 0 6 0 | | | | | |
| | | | | | P Z | 1 0 2 0 1 | | | | | |
|   incl. handle blocks | | 150 | 1000 | 660 | S 2 A | 4 3 1 0 8 7 | | | | | |
| mirror cabinet 3 double mirror doors 2 central partitions, 6 glass shelves 1 LED panel light round 14,7 watt / converter 30 watt 1208 lumens / (2700 -) 6500 Kelvin 1 switch socket element Door width: 296 mm / 396 mm / 296 mm This product contains a light source with energy efficiency class: F Additional accessories LED washbasin lighting LED washbasin lighting emotion Emotion lighting | | | | | | | | | | | |
| | | | | | P Z | 1 0 6 3 9 0 | | | | | |
| | | | | | P Z | 1 1 5 0 9 0 | | | | | |
| | | | | | P Z | 1 0 2 0 1 | | | | | |
|   incl. handle blocks | | 150 | 1200 | 660 | S 2 A | 4 3 1 2 8 7 | | | | | |
| mirror cabinet 3 double mirror doors 2 central partitions, 6 glass shelves 1 LED panel light round 17,8 watt / converter 30 watt 1462 lumens / (2700 -) 6500 Kelvin 1 switch socket element Door width: 388 mm / 412 mm / 388 mm This product contains a light source with energy efficiency class: F Additional accessories LED washbasin lighting LED washbasin lighting emotion Emotion lighting | | | | | | | | | | | |
| | | | | | P Z | 1 0 6 3 1 2 | | | | | |
| | | | | | P Z | 1 1 5 0 1 2 | | | | | |
| | | | | | P Z | 1 0 2 0 1 | | | | | |

b - bright - model list

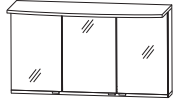
| Depth indication corresponds to the carcass depth | Depth in mm | Width in mm | Height in mm | Article number | Hinge |
|--|-------------|-------------|--------------|--------------------------|-------|
| Mirror cabinets Series A | | | | | |
|   <p>incl. handle blocks</p> <p>mirror cabinet 3 double mirror doors 2 central partitions, 6 glass shelves 1 LED panel light round 20,9 watt / converter 30 watt 1716 lumens / (2700 -) 6500 Kelvin 1 switch socket element Door width: 446 mm / 496 mm / 446 mm This product contains a light source with energy efficiency class: F</p> <p>Additional accessories LED washbasin lighting LED washbasin lighting emotion Emotion lighting</p> | 150 | 1400 | 660 | S 2 A 4 3 1 4 8 7 | |
| Mirror cabinets Series B | | | | | |
|   <p>incl. handle blocks</p> <p>mirror cabinet 3 double mirror doors 2 central partitions, 6 glass shelves 1 LED panel light above round 230 mm deep 1 LED panel light below angled 150 mm deep per 11,6 watt / 1090 lumens / 2700 - 6500 Kelvin 1 LED converter 30 W Emotion lighting 1 switch socket element Door width: 196 mm / 396 mm / 196 mm This product contains a light source with energy efficiency class: F</p> | 150 | 800 | 660 | S E T 4 3 8 0 B 2 | |
|   <p>incl. handle blocks</p> <p>mirror cabinet 3 double mirror doors 2 central partitions, 6 glass shelves 1 LED panel light above round 230 mm deep 1 LED panel light below angled 150 mm deep per 14,7 watt / 1382 lumens / 2700 - 6500 Kelvin 1 LED converter 30 W Emotion lighting 1 switch socket element Door width: 296 mm / 396 mm / 296 mm This product contains a light source with energy efficiency class: F</p> | 150 | 1000 | 660 | S E T 4 3 1 0 B 2 | |

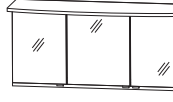
b - bright - model list

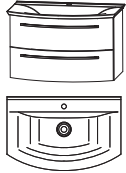
| Depth indication corresponds to the carcass depth | Depth in mm | Width in mm | Height in mm | Article number | | | Hinge | | | |
|---|-------------|-------------|--------------|--------------------------|---|---|-------|---|--|--|
| <p>Mirror cabinets Series B</p>   <p>incl. handle blocks</p> <p>mirror cabinet 3 double mirror doors 2 central partitions, 6 glass shelves 1 LED panel light above round 230 mm deep 1 LED panel light below angled 150 mm deep per 17,8 watt / 1673 lumens / 2700 - 6500 Kelvin 1 LED converter 60 W 1 switch socket element Emotion lighting Door width: 388 mm / 412 mm / 388 mm This product contains a light source with energy efficiency class: F</p> | 150 | 1200 | 660 | S E T 4 3 1 2 B 2 | | | | | | |
|   <p>incl. handle blocks</p> <p>mirror cabinet 3 double mirror doors 2 central partitions, 6 glass shelves 1 LED panel light above round 230 mm deep 1 LED panel light below angled 150 mm deep per 20,9 watt / 1964 lumens / 2700 - 6500 Kelvin 1 LED converter 60 W Emotion lighting 1 switch socket element Door width: 446 mm / 496 mm / 446 mm This product contains a light source with energy efficiency class: F</p> | 150 | 1400 | 660 | S E T 4 3 1 4 B 2 | | | | | | |
| <p>Sets</p>  <p>Consisting of: STONEPLUS - washbasin white incl. CLOU drain and overflow system in chrome Washbasin base unit 800 mm 1 metal pull out unit with buffered closing 1 metal pull out unit with buffered closing and rail</p> <p>without LED lighting</p> <p>with LED lighting 3,6 Watt / converter 15 Watt 324 lumens / 6500 Kelvin This product contains a light source with energy efficiency class: F</p> <p>Additional accessories Space-saving drain stench trap DN 40 Space-saving drain stench trap DN 32 motion sensor for LED lighting</p> | 536 | 829 | 510 | S E T B R 8 0 6 1 | | | | | | |
| | 536 | 829 | 510 | S E T B R 8 0 B 6 | | | | | | |
| | | | | P Z | 1 | 3 | 6 | 7 | | |
| | | | | P Z | 1 | 4 | 2 | 3 | | |
| | | | | P Z | 1 | 1 | 4 | 1 | | |

You find information on the the washbasin manufacturer at the beginning of the sales book.

b - bright - model list

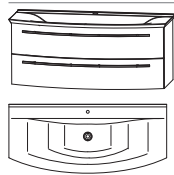
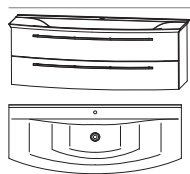
| Depth indication corresponds to the carcass depth | Depth in mm | Width in mm | Height in mm | Article number | Hinge |
|---|-------------|-------------|--------------|---|-------|
| Sets | | | | | |
|  <p>Consisting of: STONEPLUS - washbasin white incl. CLOU drain and overflow system in chrome washbasin base unit 1000 mm 1 metal pull out unit with buffered closing 1 metal pull out unit with buffered closing and rail</p> <p>without LED lighting</p> <p>with LED lighting 4,6 Watt / converter 15 Watt 410 lumens / 6500 Kelvin This product contains a light source with energy efficiency class: F</p> <p>Additional accessories Space-saving drain stench trap DN 40 Space-saving drain stench trap DN 32 motion sensor for LED lighting</p> | 536 | 1029 | 510 | SETBR1061 | |
| | 536 | 1029 | 510 | SETBR10B6 | |
|  <p>Consisting of: STONEPLUS - washbasin white incl. CLOU drain and overflow system in chrome washbasin base unit 1200 mm 1 metal pull out unit with buffered closing 1 metal pull out unit with buffered closing and rail</p> <p>without LED lighting</p> <p>with LED lighting 5,5 Watt / converter 15 Watt 497 lumens / 6500 Kelvin This product contains a light source with energy efficiency class: F</p> <p>Additional accessories Space-saving drain stench trap DN 40 Space-saving drain stench trap DN 32 motion sensor for LED lighting</p> | 536 | 1229 | 510 | SETBR1261 | |
| | 536 | 1229 | 510 | SETBR12B6 | |
|  <p>Consisting of: STONEPLUS - washbasin white incl. CLOU drain and overflow system in chrome washbasin base unit 1400 mm 1 metal pull out unit with buffered closing 1 metal pull out unit with buffered closing and rail</p> <p>without LED lighting</p> <p>with LED lighting 6,8 Watt / converter 15 Watt 583 lumens / 6500 Kelvin This product contains a light source with energy efficiency class: F</p> <p>Additional accessories Space-saving drain stench trap DN 40 Space-saving drain stench trap DN 32 motion sensor for LED lighting</p> | 536 | 1429 | 510 | SETBR1461 | |
| | 536 | 1429 | 510 | SETBR14B6 | |
| | | | | P Z 1 3 6 7 P Z 1 4 2 3 P Z 1 1 4 1 | |

You find information on the the washbasin manufacturer at the beginning of the sales book.

b - bright - model list

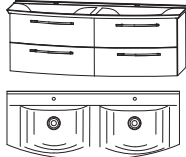
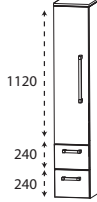
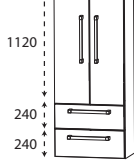
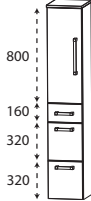
| Depth indication corresponds to the carcass depth | Depth in mm | Width in mm | Height in mm | Article number | Hinge |
|---|-------------|-------------|--------------|---|-------|
| <p>Sets</p>  <p>Consisting of: STONEPLUS double washbasin white incl. 2 CLOU drain and overflow systems in chrome Washbasin base unit 2x 700 mm 2 metal pull out units with buffered closing and syphon cut- out 2 metal pull-out units with buffered closing incl. drawer rail</p> <p>without LED lighting</p> <p>with LED lighting 6,8 Watt / converter 15 Watt 583 lumens / 6500 Kelvin This product contains a light source with energy efficiency class: F</p> <p>Additional accessories Space-saving drain stench trap DN 40 (order 2 pieces) Space-saving drain stench trap DN 32 (order 2 pieces) motion sensor for LED lighting</p> | 557 | 1429 | 510 | S E T B R 4 D 6 1 | |
| | 557 | 1429 | 510 | S E T B R 4 D B 6 | |
| | | | | P Z 1 3 6 7 P Z 1 4 2 3 P Z 1 1 4 1 | |
| <p>Tall units</p>  <p>Tall unit 1 door with buffered closing 4 glass shelves 2 metal pull-outs with buffered closing, 1 top cover 330 mm deep</p> | 300 | 300 | 1628 | H N A 0 8 3 0 2 E | L/R |
| | 300 | 400 | 1628 | H N A 0 8 4 0 2 E | L/R |
|  <p>Tall unit 2 doors with buffered closing 4 glass shelves 2 metal pull-outs with buffered closing 1 top cover 330 mm deep</p> | 300 | 600 | 1628 | H N A 0 8 6 0 2 E | |
|  <p>Tall unit 1 door with buffered closing 2 glass shelves (top) 1 drawer with buffered closing 2 metal pull-outs with buffered closing 1 top cover 330 mm deep</p> | 300 | 300 | 1628 | H N A 0 9 3 0 2 E | L/R |
| | 300 | 400 | 1628 | H N A 0 9 4 0 2 E | L/R |

You find information on the the washbasin manufacturer at the beginning of the sales book.

b - bright - model list

Depth indication corresponds to the carcass depth

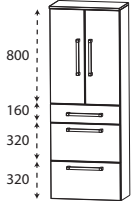
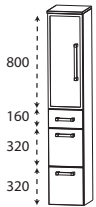
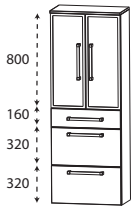
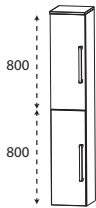
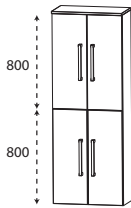
| | Depth in mm | Width in mm | Height in mm | Article number | Hinge | | | |
|---|----------------|----------------|-----------------|------------------|-------|--|--|--|
|  <p>Tall unit 2 doors with buffered closing 2 glass shelves (top) 1 drawer with buffered closing 2 metal pull-outs with buffered closing 1 top cover 330 mm deep</p> | 300 | 600 | 1628 | HNA09602E | | | | |
|  <p>Tall unit 1 aluminium framed door with satined glass 2 glass shelves (top) 1 drawer with buffered closing 2 metal pull-outs with buffered closing 1 top cover 330 mm deep</p> | 300 | 300 | 1628 | HNA09303E | L/R | | | |
|  <p>Tall unit 2 aluminium framed doors with satined glass 2 glass shelves (top) 1 drawer with buffered closing 2 metal pull-outs with buffered closing 1 top cover 330 mm deep</p> | 300 | 600 | 1628 | HNA09603E | | | | |
|  <p>Tall unit 2 doors with buffered closing 2 glass shelves (top) 2 adjustable shelves (bottom) 1 top cover 330 mm deep</p> <p>Variable in width: please quote the exact dimension of carcass depth. Top cover will be adapted to the cupboard width.</p> | 300 | 300 | 1628 | HNA03302E | L/R | | | |
| | 300 | 400 | 1628 | HNA03402E | L/R | | | |
| | 150-299 | 300 | 1628 | HVA0330 | L/R | | | |
| | 150-299 | 400 | 1628 | HVA0340 | L/R | | | |
|  <p>Tall unit 4 door with buffered closing 2 glass shelves (top) 2 adjustable shelves (bottom) 1 top cover 330 mm deep</p> <p>Variable in width: please quote the exact dimension of carcass depth. Top cover will be adapted to the cupboard width.</p> | 300 | 600 | 1628 | HNA03602E | | | | |
| | 150-299 | 600 | 1628 | HVA0360 | | | | |

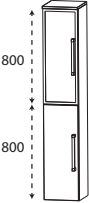
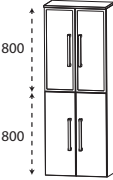
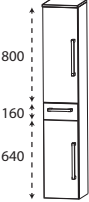
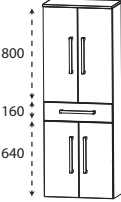
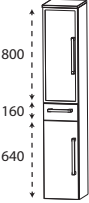

b - bright - model list

| Depth indication corresponds to the carcass depth | | Depth in mm | Width in mm | Height in mm | Article number | Hinge | | | |
|--|--|----------------|----------------|-----------------|--------------------------|-------|--|--|--|
| Tall units | | | | | | | | | |
|  | Tall unit 1 aluminium framed door with satined glass 2 glass shelves (top) 1 door with buffered closing 2 adjustable shelves (bottom) 1 top cover 330 mm deep | 300 | 300 | 1628 | H N A 0 3 3 0 3 E | L/R | | | |
| | Variable in width: please quote the exact dimension of carcass depth. Top cover will be adapted to the cupboard width. | 150-299 | 300 | 1628 | H V A 0 3 3 1 | L/R | | | |
|  | Tall unit 2 aluminium framed doors with satined glass 2 glass shelves (top) 2 doors with buffered closing 2 adjustable shelves (bottom) 1 top cover 330 mm deep | 300 | 600 | 1628 | H N A 0 3 6 0 3 E | | | | |
| | Variable in width: please quote the exact dimension of carcass depth. Top cover will be adapted to the cupboard width. | 150-299 | 600 | 1628 | H V A 0 3 6 1 | | | | |
|  | Tall unit 1 door with buffered closing 2 glass shelves (top) 1 drawer with buffered closing 1 door with buffered closing 1 glass shelf 1 top cover 330 mm deep | 300 | 300 | 1628 | H N A 0 5 3 0 2 E | L/R | | | |
| | | 300 | 400 | 1628 | H N A 0 5 4 0 2 E | L/R | | | |
|  | Tall unit 2 doors with buffered closing 2 glass shelves (top) 1 drawer with buffered closing 2 doors with buffered closing 1 glass shelf 1 top cover 330 mm deep | 300 | 600 | 1628 | H N A 0 5 6 0 2 E | | | | |
| | | | | | | | | | |
|  | Tall unit 1 aluminium framed door with buffered closing 2 glass shelves (top) 1 drawer with buffered closing 1 door with buffered closing 1 glass shelf 1 top cover 330 mm deep | 300 | 300 | 1628 | H N A 0 5 3 0 3 E | L/R | | | |
| | | | | | | | | | |

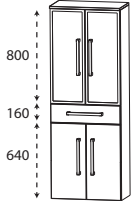
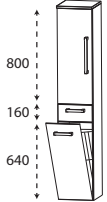
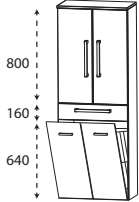
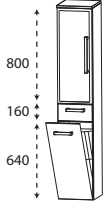
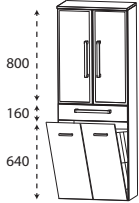
b - bright - model list

| Depth indication corresponds to the carcass depth | | Depth in mm | Width in mm | Height in mm | Article number | Hinge | ge high- gloss carcass | ge chro- me edge pull-out |
|---|--|----------------|----------------|-----------------|--|-------|------------------------------|---------------------------------|
| Tall units | | | | | | | | |
|  | <p>Tall unit 2 aluminium framed doors with buffered closing 2 glass shelves (top) 1 drawer with buffered closing 2 doors with buffered closing 1 glass shelf 1 top cover 330 mm deep</p> | 300 | 600 | 1628 | HNA05603E | | | |
|  | <p>Tall unit with laundry basket 1 door with buffered closing 2 glass shelves 1 drawer with buffered closing 1 laundry basket with wire basket 1 top cover 330 mm deep</p> <p>Volume of laundry basket: 25 liters Volume of laundry basket: 35 liters</p> | 300 300 | 300 400 | 1628 1628 | HNA05302W L/R HNA05402W L/R | | | |
|  | <p>Tall unit with laundry basket 2 doors with buffered closing 2 glass shelves 1 drawer with buffered closing 1 laundry basket with wire basket 1 top cover 330 mm deep</p> <p>Volume of laundry basket: 55 liters</p> | 300 | 600 | 1628 | HNA05602W | | | |
|  | <p>Tall unit with laundry basket 1 aluminium framed door with satined glass 2 glass shelves 1 drawer with buffered closing 1 laundry basket with wire basket 1 top cover 330 mm deep</p> <p>Volume of laundry basket: 25 liters</p> | 300 | 300 | 1628 | HNA05303W L/R | | | |
|  | <p>Tall unit with laundry basket 2 aluminium framed doors with satined glass 2 glass shelves 1 drawer with buffered closing 1 laundry basket with wire basket 1 top cover 330 mm deep</p> <p>Volume of laundry basket: 55 liters</p> | 300 | 600 | 1628 | HNA05603W | | | |

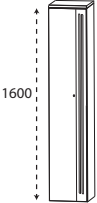
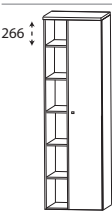
b - bright - model list

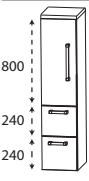
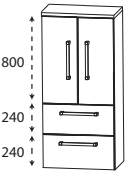
| Depth indication corresponds to the carcass depth | | Depth in mm | Width in mm | Height in mm | Article number | Hinge | Surcharge high-gloss carcass | Surcharge chrome edge pull-out |
|---|--|-------------|-------------|--------------|--------------------------|-------|------------------------------|--------------------------------|
| Tall units | | | | | | | | |
|  | Tall unit 1 double mirror door with buffered closing 1 mirror panel incl. LED lighting 14,4 Watt 1220 lumens / 2700 - 6500 Kelvin 4 glass shelves 1 fixed shelf 1 top cover 310 mm deep incl. converter 15 Watt and sensor switch element This product contains a light source with energy efficiency class: F | 300 | 400 | 1628 | H N A 0 1 4 A 1 E | L/R | | |
| | Variable in width: please quote the exact dimension of carcass depth. Top cover will be adapted to the cupboard width. | 150-299 | 400 | 1628 | H V A 0 1 4 0 1 | L/R | | |
|   Ill. = right | Tall unit 1 double mirror door 6 glass shelves 1 shelf 5 shelves mirrored back side with sensor for emotion lighting 26,9 watt / converter 30 watt 2959 lumens / 3000 - 6500 Kelvin 1 top cover 310 mm deep This product contains a light source with energy efficiency class: F | 300 | 500 | 1628 | R H N 0 1 5 0 2 E | L/R | | |
| Central units | | | | | | | | |
|  | medium-high unit 1 door with buffered closing 2 glass shelves 2 metal pull-outs with buffered closing 1 top cover 330 mm deep | 300 | 300 | 1308 | M N A 8 7 3 0 2 E | L/R | | |
| | | 300 | 400 | 1308 | M N A 8 7 4 0 2 E | L/R | | |
|  | medium-high unit 2 doors with buffered closing 2 glass shelves 2 metal pull-outs with buffered closing 1 top cover 330 mm deep | 300 | 600 | 1308 | M N A 8 7 6 0 2 E | | | |

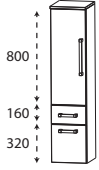
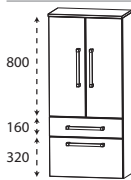
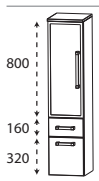
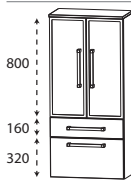
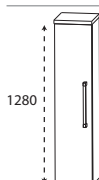
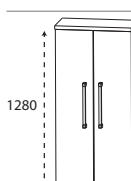

b - bright - model list

| Depth indication corresponds to the carcass depth | | Depth in mm | Width in mm | Height in mm | Article number | Hinge | | | |
|--|---|----------------|----------------|-----------------|------------------|------------------|-----|--|--|
| Central units | | | | | | | | | |
|  <p>800 160 320</p> | medium-high unit 1 door with buffered closing 2 glass shelves (top) 1 drawer with buffered closing 1 metal pull-out with buffered closing, 1 top cover 330 mm deep | 300 | 300 | 1308 | MNA88302E | L/R | | | |
| | | | 300 | 400 | 1308 | MNA88402E | L/R | | |
|  <p>800 160 320</p> | medium-high unit 2 doors with buffered closing 2 glass shelves (top) 1 drawer with buffered closing 1 metal pull-out with buffered closing, 1 top cover 330 mm deep | 300 | 600 | 1308 | MNA88602E | | | | |
| | | | | | | | | | |
|  <p>800 160 320</p> | medium-high unit 1 aluminium framed door with satined glass 2 glass shelves (top) 1 drawer with buffered closing 1 metal pull-out with buffered closing, 1 top cover 330 mm deep | 300 | 300 | 1308 | MNA88303E | L/R | | | |
| | | | | | | | | | |
|  <p>800 160 320</p> | medium-high unit 2 aluminium framed doors with satined glass 2 glass shelves (top) 1 drawer with buffered closing 1 metal pull-out with buffered closing, 1 top cover 330 mm deep | 300 | 600 | 1308 | MNA88603E | | | | |
| | | | | | | | | | |
|  <p>1280</p> | medium-high unit 1 door with buffered closing 4 glass shelves 1 top cover 330 mm deep | 300 | 300 | 1308 | MNA81302E | L/R | | | |
| | | | 300 | 400 | 1308 | MNA81402E | L/R | | |
| | Variable in width: please quote the exact dimension of carcass depth. | 150-299 | 300 | 1308 | MVA8130 | L/R | | | |
| | Top cover will be adapted to the cupboard width. | 150-299 | 400 | 1308 | MVA8140 | L/R | | | |
|  <p>1280</p> | medium-high unit 2 doors with buffered closing 4 glass shelves 1 top cover 330 mm deep | 300 | 600 | 1308 | MNA81602E | | | | |
| | Variable in width: please quote the exact dimension of carcass depth. Top cover will be adapted to the cupboard width. | 150-299 | 600 | 1308 | MVA8160 | | | | |

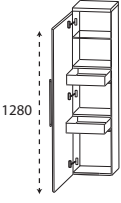
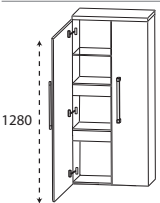
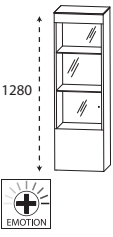
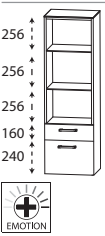
b - bright - model list

| Depth indication corresponds to the carcass depth | | Depth in mm | Width in mm | Height in mm | Article number | Hinge | | | |
|--|---|----------------|----------------|-----------------|------------------------|---------|---|--|--|
| Central units | | | | | | | | | |
|  | medium-high unit with inside drawer 1 door with buffered closing 2 inside metal- drawers with buffered closing 1 glass shelf 1 top cover 330 mm deep | 300 | 300 | 1308 | MNA 8 4 3 0 2 E | L/R | | | |
| | | 300 | 400 | 1308 | MNA 8 4 4 0 2 E | L/R | | | |
|  | medium-high unit with inside drawer 2 doors with buffered closing 1 continuous glass shelf 2 continuously inside metal-drawer with buffered closing 1 top cover 330 mm deep | 300 | 600 | 1308 | MNA 8 4 6 0 2 E | | | | |
|  | medium-high unit - display cabinet 1 white printed glas door, with buffered closing 2 LED glass shelves 2 x 0,8 watt 2 x 27 lumens / (3000 -) 6500 Kelvin 1 fixed shelf 1 glass shelf incl. sensor switcher incl. converter 15 Watt 1 top cover 310 mm deep This product contains a light source with energy efficiency class: F Additional accessories Emotion lighting | 300 | 400 | 1308 | MNA 8 1 4 A 8 E | L/R | | | |
|  | medium-high unit 2 LED glass shelves 2 x 0,8 watt 2 x 27 lumens / (3000 -) 6500 Kelvin 1 drawer with buffered closing 1 metal pull out unit with buffered closing and rail incl. converter 15 Watt incl. sensor switcher 1 top cover 310 mm deep This product contains a light source with energy efficiency class: F Additional accessories Emotion lighting | 300 | 400 | 1308 | MNA 8 8 4 A 8 E | | | | |
| | | | | | PZ | 1 0 2 0 | 1 | | |
| | | | | | PZ | 1 0 2 0 | 1 | | |

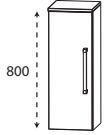
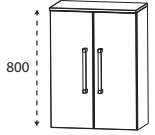
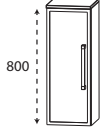
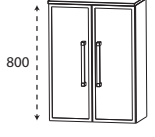
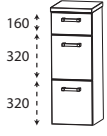
b - bright - model list

| Depth indication corresponds to the carcass depth | | Depth in mm | Width in mm | Height in mm | Article number | Hinge | | | |
|---|--|----------------|----------------|-----------------|--------------------------|-------|--|--|--|
| Highboards | | | | | | | | | |
|  | Highboard 1 door with buffered closing 2 glass shelves 1 top cover 330 mm deep | 300 | 300 | 828 | H B A 5 1 3 0 2 E | L/R | | | |
| | | 300 | 400 | 828 | H B A 5 1 4 0 2 E | L/R | | | |
| | Variable in width: please quote the exact dimension of carcass depth. | 150-299 | 300 | 828 | H B V A 5 1 3 | L/R | | | |
| | Top cover will be adapted to the cupboard width. | 150-299 | 400 | 828 | H B V A 5 1 4 | L/R | | | |
|  | Highboard 2 doors with buffered closing 2 glass shelves 1 top cover 330 mm deep | 300 | 600 | 828 | H B A 5 1 6 0 2 E | | | | |
| | Variable in width: please quote the exact dimension of carcass depth. Top cover will be adapted to the cupboard width. | 150-299 | 600 | 828 | H B V A 5 1 6 | | | | |
|  | Highboard 1 aluminium framed door with satined glass 2 glass shelves 1 top cover 330 mm deep | 300 | 300 | 828 | H B A 5 1 3 0 3 E | L/R | | | |
| | Variable in width: please quote the exact dimension of carcass depth. Top cover will be adapted to the cupboard width. | 150-299 | 300 | 828 | H B V A 5 1 3 | 1 L/R | | | |
|  | Highboard 2 aluminium framed doors with satined glass 2 glass shelves 1 top cover 330 mm deep | 300 | 600 | 828 | H B A 5 1 6 0 3 E | | | | |
| | Variable in width: please quote the exact dimension of carcass depth. Top cover will be adapted to the cupboard width. | 150-299 | 600 | 828 | H B V A 5 1 6 | 1 | | | |
|  | Highboard 1 drawer with buffered closing 2 metal pull-outs with buffered closing 1 top cover 330 mm deep | 300 | 300 | 828 | H B A 5 6 3 0 2 E | | | | |
| | | 300 | 400 | 828 | H B A 5 6 4 0 2 E | | | | |
|  | Highboard 1 drawer with buffered closing 2 metal pull-outs with buffered closing 1 top cover 330 mm deep | 300 | 600 | 828 | H B A 5 6 6 0 2 E | | | | |
| | | | | | | | | | |

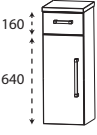
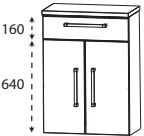
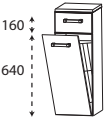
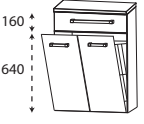
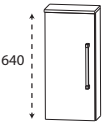
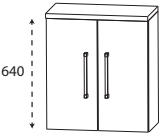

b - bright - model list

| Depth indication corresponds to the carcass depth | | Depth in mm | Width in mm | Height in mm | Article number | Hinge | | | |
|--|--|----------------|----------------|-----------------|--------------------------------------|-------|--|--|--|
| Highboards | | | | | | | | | |
|  | Highboard 1 drawer with buffered closing 1 door with buffered closing 1 glass shelf 1 top cover 330 mm deep | 300 | 300 | 828 | HBA55302E | L/R | | | |
| | | 300 | 400 | 828 | HBA55402E | L/R | | | |
|  | Highboard 1 drawer with buffered closing 2 doors with buffered closing 1 glass shelf 1 top cover 330 mm deep | 300 | 600 | 828 | HBA55602E | | | | |
|  | Highboard with laundry basket 1 drawer with buffered closing 1 laundry basket with wire basket 1 top cover 330 mm deep | | | | | | | | |
| | Volume of laundry basket: 25 liters Volume of laundry basket: 35 liters | 300 300 | 300 400 | 828 828 | HBA55302W HBA55402W | | | | |
|  | Highboard with laundry basket 1 drawer with buffered closing 1 laundry basket with wire basket 1 top cover 330 mm deep | | | | | | | | |
| | Volume of laundry basket: 55 liters | 300 | 600 | 828 | HBA55602W | | | | |
| Wall units | | | | | | | | | |
|  | Wall unit 1 door with buffered closing 1 glass shelf 1 top cover 180 mm deep | 150 | 300 | 668 | OGA41302E | L/R | | | |
| | | 150 | 400 | 668 | OGA41402E | L/R | | | |
| | Variable in width: please quote the exact dimension of carcass depth. Top cover will be adapted to the cupboard width. | 151-300 | 300 | 668 | OVA4130 | L/R | | | |
| | | 151-300 | 400 | 668 | OVA4140 | L/R | | | |
|  | Wall unit 2 doors with buffered closing 1 glass shelf 1 top cover 180 mm deep | 150 | 600 | 668 | OGA41602E | | | | |
| | Variable in width: please quote the exact dimension of carcass depth. Top cover will be adapted to the cupboard width. | 151-300 | 600 | 668 | OVA4160 | | | | |

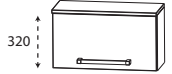
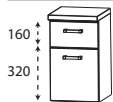
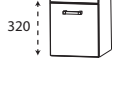
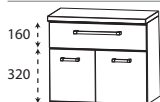
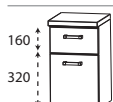
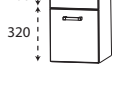
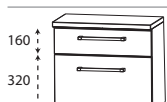
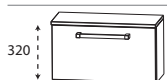

b - bright - model list

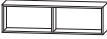
| Depth indication corresponds to the carcass depth | | Depth in mm | Width in mm | Height in mm | Article number | Hinge | | | |
|---|--|----------------|----------------|-----------------|------------------------|-------|--|--|--|
| Wall units | | | | | | | | | |
|  | Wall unit 1 flap door, 1 top cover 260 mm deep | 230 | 600 | 348 | OMA 2 1 6 0 K E | | | | |
| Base units | | | | | | | | | |
|  | Base unit 1 drawer with buffered closing 1 door with buffered closing 1 top cover 330 mm deep | 300 | 300 | 508 | UNA 3 2 3 0 2 E | L/R | | | |
|  | | 300 | 400 | 508 | UNA 3 2 4 0 2 E | L/R | | | |
|  | Base unit 1 drawer with buffered closing 2 doors with buffered closing 1 top cover 330 mm deep | 300 | 600 | 508 | UNA 3 2 6 0 2 E | | | | |
|  | Base unit 1 drawer with buffered closing 1 metal pull-out with buffered closing, 1 top cover 330 mm deep | 300 | 300 | 508 | UNA 3 4 3 0 2 E | | | | |
|  | | 300 | 400 | 508 | UNA 3 4 4 0 2 E | | | | |
|  | Base unit 1 drawer with buffered closing 1 metal pull-out with buffered closing, 1 top cover 330 mm deep | 300 | 600 | 508 | UNA 3 4 6 0 2 E | | | | |
|  | Base unit 1 flap door, 1 top cover 260 mm deep | 230 | 600 | 348 | UMA 2 1 6 0 K E | | | | |

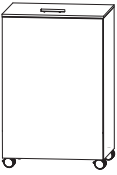





b - bright - model list

| Depth indication corresponds to the carcass depth | | Depth in mm | Width in mm | Height in mm | Article number | Hinge | | | |
|--|---|----------------|----------------|-----------------|------------------------|-------|--|--|--|
| Shelves | | | | | | | | | |
|  | <p>functional shelf Edges are cut with a mitre vertical and horizontal mounting possible</p> <p>please indicate colour version: no. 501 white matt lacquered no. 547 black matt lacquered</p> | 150 | 300 | 160 | RGL 1 1 3 0 0 1 | | | | |
|  | <p>functional shelf Edges are cut with a mitre vertical and horizontal mounting possible</p> <p>please indicate colour version: no. 501 white matt lacquered no. 547 black matt lacquered</p> | 150 | 600 | 160 | RGL 1 1 6 0 0 2 | | | | |
|  | <p>functional shelf Edges are cut with a mitre vertical and horizontal mounting possible</p> <p>please indicate colour version: no. 501 white matt lacquered no. 547 black matt lacquered</p> | 150 | 900 | 160 | RGL 1 1 9 0 0 3 | | | | |
| Laundryrolli | | | | | | | | | |
|  | <p>Laundryrolli 1 flap door, with buffered closing 1 take-out laundry-bag, washable 4 roles Colour version corresponds to the carcass colour</p> <p>incl. height indication rolls (100 mm)</p> | 470 | 470 | 756 | WRS 4 0 4 7 | | | | |





b - bright - model list

| Depth indication corresponds to the carcass depth | | Depth in mm | Width in mm | Height in mm | Article number | | Hinge | | | |
|---|--|----------------|----------------|-----------------|--------------------------|--|-------|--|--|--|
| Glass shelves | | | | | | | | | | |
|  | Glass shelf incl. metal holder | | | | | | | | | |
| | 400 mm wide incl. 2 metal brackets | 130 | 400 | 8 | A B G 1 3 4 0 0 8 | | | | | |
| | 600 mm wide incl. 2 metal brackets | 130 | 600 | 8 | A B G 1 3 6 0 0 8 | | | | | |
| | 800 mm wide incl. 2 metal brackets | 130 | 800 | 8 | A B G 1 3 8 0 0 8 | | | | | |
| | 1000 mm wide incl. 3 metal brackets | 130 | 1000 | 8 | A B G 1 3 1 0 0 8 | | | | | |
| | 1200 mm wide incl. 3 metal brackets | 130 | 1200 | 8 | A B G 1 3 1 2 0 8 | | | | | |
| | 1400 mm wide incl. 4 metal brackets | 130 | 1400 | 8 | A B G 1 3 1 4 0 8 | | | | | |
| Push- fit shelf | | | | | | | | | | |
|  | Push- fit shelf with ABS thick edge all around incl. holders for push fit shelf | | | | | | | | | |
| | 300 mm wide incl. 2 push-fit holder | 150 | 300 | 28 | S B G 6 0 3 0 | | | | | |
| | 400 mm wide incl. 2 push-fit holder | 150 | 400 | 28 | S B G 6 0 4 0 | | | | | |
| | 600 mm wide incl. 2 push-fit holder | 150 | 600 | 28 | S B G 6 0 6 0 | | | | | |
| | 800 mm wide incl. 3 push-fit holder | 150 | 800 | 28 | S B G 6 0 8 0 | | | | | |
| | 1000 mm wide incl. 3 push-fit holder | 150 | 1000 | 28 | S B G 6 0 1 0 | | | | | |
| | 1200 mm wide incl. 3 push-fit holder | 150 | 1200 | 28 | S B G 6 0 1 2 | | | | | |
| | 1400 mm wide incl. 3 push-fit holder | 150 | 1400 | 28 | S B G 6 0 1 4 | | | | | |



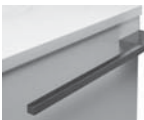



b - bright - model list

| | Depth in mm | Width in mm | Height in mm | Article number | | | | | |
|--|--|----------------|-----------------|----------------|-----|-------------|-----|-----------|--|
| Depth indication corresponds to the carcass depth | | | | | | | | | |
| Accessories | | | | | | | | | |
|  | decor panel with chrome edge no. 129 chrome round to fit underneath washbasin base units: | | | | | | | | |
| | SET BR80 61/B6 | 504 | 794 | 12 | DB | 5 0 8 0 1 2 | | | |
| | SET BR10 61/B6 | 504 | 994 | 12 | DB | 5 0 1 0 1 2 | | | |
| | SET BR12 61/B6 | 504 | 1194 | 12 | DB | 5 0 1 2 1 2 | | | |
| | SET BR14 61/B6 | 504 | 1394 | 12 | DB | 5 0 1 4 1 2 | | | |
| | SET BR4D 61/B6 | 518 | 1394 | 12 | DB | 5 2 1 4 1 2 | | | |
|  | decor panel with chrome edge no. 129 chrome angled to fit underneath furniture elements | | | | | | | | |
| | 300 mm width | 317 | 294 | 12 | DB | 3 1 3 0 1 2 | | | |
| | 400 mm wide | 317 | 394 | 12 | DB | 3 1 4 0 1 2 | | | |
| | 400 mm width HNA 014A 1E + MNA814A 8E | 300 | 394 | 12 | DB | 3 0 4 0 1 2 | | | |
| | 500 mm width RHN 0150 2E | 297 | 494 | 12 | DB | 2 9 5 0 1 2 | | | |
| | 600 mm wide | 317 | 594 | 12 | DB | 3 1 6 0 1 2 | | | |
|  | Towel holder one-armed front opened for assembling at the washbasin base unit Please observe carcass depth and furniture height | | | | | | | | |
| | Chrome hgl. | 390 | 55 | 30 | P Z | 1 1 2 8 1 1 | | | |
| | black | 390 | 55 | 30 | P Z | 1 1 2 8 1 2 | | | |
|  | Towel holder two-armed front opened for assembling at the washbasin base unit Please observe carcass depth and furniture height | | | | | | | | |
| | Chrome hgl. | 390 | 110 | 30 | P Z | 1 1 2 8 1 | | | |
| | black | 390 | 110 | 30 | P Z | 1 1 2 8 2 | | | |
|  | Towel holder one-armed swiveling for mounting to wall or carcass Please observe carcass depth and furniture height | | | | | | | | |
| | Chrome hgl. | 420 | 30 | 46 | P Z | 1 1 4 7 1 | | | |
| | black | 420 | 30 | 46 | P Z | 1 1 4 7 2 | | | |
|  | Towel holder one-armed extendable chrome gloss wall-mounted | | | 330-567 | 44 | 44 | P Z | 1 1 3 7 1 | |









b - bright - model list

| Depth indication corresponds to the carcass depth | | Depth in mm | Width in mm | Height in mm | Article number | | | Hinge | | | |
|---|---|----------------|----------------|-----------------|----------------|-------------|---|-------|--|--|--|
| Accessories | | | | | | | | | | | |
|  | Towel holder two-armed extendable chrome gloss wall-mounted | 322-562 | 87 | 47 | P Z | 1 1 3 7 | 2 | | | | |
|  | Towel holder chrome gloss to fit on carcass at side front opened Please observe carcass depth and furniture height | 390 | 60 | | P Z | 1 1 2 4 | 1 | | | | |
|  | Mirror handle for mirror cabinet door Chrome hgl. for sticking on double mirrored doors Please order one mirror handle per door! | | | | P Z | 1 1 2 5 | | | | | |
|  | Adjustable organizer components 2 dividing elements - 300 mm cabinet width 3 dividing elements - 400 mm cabinet width 4 dividing elements - 600 mm cabinet width 4 dividing elements - 700 mm cabinet width 4 dividing elements - 800 mm cabinet width 5 dividing elements - 1000 mm cabinet width 6 dividing elements - 1200 mm cabinet width 7 dividing elements - 1400 mm cabinet width | | | | P Z | 1 2 2 4 3 0 | | | | | |
| | | | | | P Z | 1 2 2 4 4 0 | | | | | |
| | | | | | P Z | 1 2 2 4 6 1 | | | | | |
| | | | | | P Z | 1 2 2 4 7 0 | | | | | |
| | | | | | P Z | 1 2 2 4 8 0 | | | | | |
| | | | | | P Z | 1 2 2 4 1 0 | | | | | |
| | | | | | P Z | 1 2 2 4 1 2 | | | | | |
| | | | | | P Z | 1 2 2 4 1 4 | | | | | |
|  | Basin organizer without fitting elements | 150 | 246 | 150 | P Z | 1 2 3 6 E 1 | | | | | |
|  | Basin organizer incl. fixing elements 2 basin organizer for 600 mm carbinet width 2 basin organizer for 700 mm carbinet width 2 basin organizer for 800 mm carbinet width 2 basin organizer for 1000 mm carbinet width 2 basin organizer for 1200 mm carbinet width 2 basin organizer for 1400 mm carbinet width | | | | P Z | 1 2 3 6 6 0 | | | | | |
| | | | | | P Z | 1 2 3 6 7 0 | | | | | |
| | | | | | P Z | 1 2 3 6 8 0 | | | | | |
| | | | | | P Z | 1 2 3 6 1 0 | | | | | |
| | | | | | P Z | 1 2 3 6 1 2 | | | | | |
| | | | | | P Z | 1 2 3 6 1 4 | | | | | |

b - bright - model list

| | Depth in mm | Width in mm | Height in mm | Article number | Hinge | | | |
|--|----------------|----------------|-----------------|--|-------|--|--|--|
| Depth indication corresponds to the carcass depth | | | | | | | | |
| Accessories | | | | | | | | |
|  <p>Drawer set for metal drawers Consisting of: - 1 aluminium-coloured plastic insert - 2 aluminium coloured dividers, adjustable for 30 cm wide cabinets for 40 cm width units</p> | | | | P Z 1 2 2 5 3 0 P Z 1 2 2 5 4 0 | | | | |
|  <p>USB socket element 2 plus-in slots connection 220 V with clamp</p> <p>installed in mirror cabinet please state position</p> <p>not installed in mirror cabinet</p> | 45 | 80 | 64 | P Z 1 1 5 1 E B | | | | |
|  <p>LED washbasin lighting emotion 2,6 Watt / 187 lumens / (2700 -) 6500 Kelvin 1 switch element IED converter This product contains a light source with energy efficiency class: G</p> <p>LED mood lighting available as an option</p> | 16 | 560 | 7 | P Z 1 1 5 0 6 0 | | | | |
|  <p>LED washbasin lighting emotion 4,0 Watt / 287 lumens / (2700 -) 6500 Kelvin 1 switch element IED converter This product contains a light source with energy efficiency class: G</p> <p>LED mood lighting available as an option</p> | 16 | 860 | 7 | P Z 1 1 5 0 9 0 | | | | |
|  <p>LED washbasin lighting emotion 5,4 watt / 388 lumens / (2700 -) 6500 Kelvin 1 switch element IED converter This product contains a light source with energy efficiency class: G</p> <p>LED mood lighting available as an option</p> | 16 | 1160 | 7 | P Z 1 1 5 0 1 2 | | | | |
|  <p>LED washbasin lighting 2,4 Watt / 168 lumens / 6500 Kelvin 1 switch element to fit underneath mirror cabinet This product contains a light source with energy efficiency class: G</p> <p>not suitable with Emotion lighting</p> | 10 | 560 | 10 | P Z 1 0 6 3 6 0 | | | | |
|  <p>LED washbasin lighting 3,9 Watt / 287 lumens / 6500 Kelvin 1 switch element to fit underneath mirror cabinet This product contains a light source with energy efficiency class: G</p> <p>not suitable with Emotion lighting</p> | 10 | 860 | 10 | P Z 1 0 6 3 9 0 | | | | |

b - bright - model list

| Depth indication corresponds to the carcass depth | | Depth in mm | Width in mm | Height in mm | Article number | | | Hinge | | | |
|---|---|----------------|----------------|-----------------|----------------|-------------|--|-------|--|--|--|
| Accessories | | | | | | | | | | | |
|  | <p>LED washbasin lighting 5,3 Watt / 371 lumens / 6500 Kelvin 1 switch element to fit underneath mirror cabinet This product contains a light source with energy efficiency class: G</p> <p>not suitable with Emotion lighting</p> | 10 | 1160 | 10 | P Z | 1 0 6 3 1 2 | | | | | |
|  | <p>Touch LED Dimmer for LED mirror cabinets and lightings</p> | | | | P Z | 1 0 5 7 | | | | | |
|  | <p>Emotion lighting sensor switcher for dimming and for colour change control</p> <p>for all identified cabinets</p> | | | | P Z | 1 0 2 0 1 | | | | | |
|  | | | | | | | | | | | |
|  | <p>Motion sensor for LED lighting of washbasins or washbasin base units Term and sensitivity of lighting are adjustable</p> | | | | P Z | 1 1 4 1 | | | | | |
|  | <p>Remote switch incl. receiver for LED lighting for dimming and for colour change control Reach up to 5 meters</p> <p>not suitable for LED converter over 30 watt</p> | | 85 | 85 | P Z | 1 1 4 3 | | | | | |
|  | <p>Space-saving drain stretch trap from GEBERIT made of plastic, in white nominal diameter: 40</p> | | | | P Z | 1 3 6 7 | | | | | |
|  | <p>Space-saving drain stretch trap from GEBERIT made of plastic, in white nominal diameter: 32</p> | | | | P Z | 1 4 2 3 | | | | | |

b - bright - dimensional drawings

SET BR80 61/B6

SET BR10 61/B6

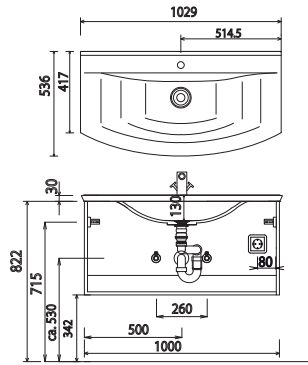
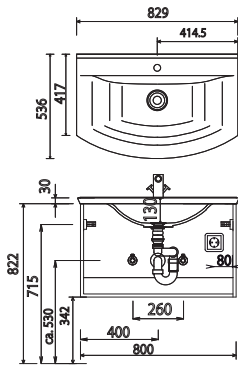

SET BR12 61/B6

SET BR14 61/B6

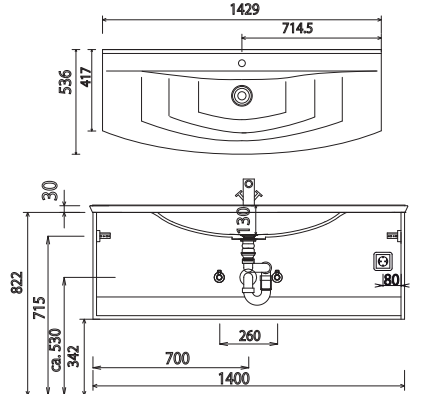
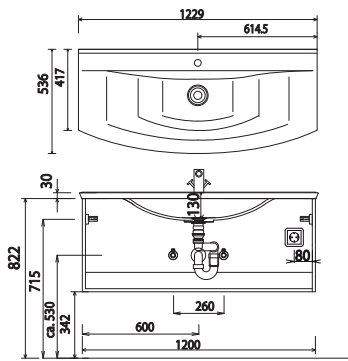

SET BR4D 61/B6

electrical connections for mirror cabinets

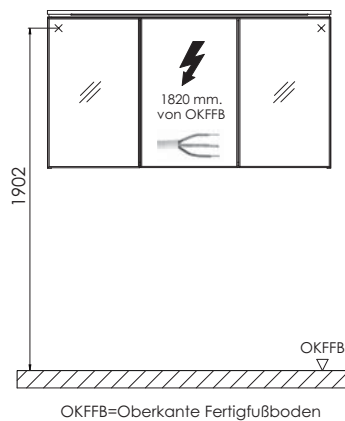
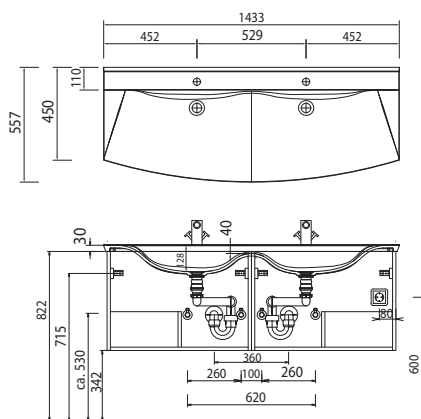

Washing stands without anchoring brackets have to be fixed on the wall and on the furniture-side with silicon!

STONEPLUS:

The water temperature must not exceed 55° C / 131° F. Hair tinting lotions have to be removed in a few seconds, so that staining can be avoided.

Modifications:

Technical modifications (+/- 5mm) and flatness modifications (DIN 18202) are subject of the usual material-specific modifications for construction materials, based on DIN 18202.