



Front colours



No. 777 cosmos grey matt



No. 893 titanium grey matt



No. 722 polar white hgl.



No. 686 anthracite hgl.



no. 670 Halifax oak



No. 750 cardiff oak



no. 751 Cuneo oak brown



no. 771 Cuneo oak natural



Nr. 785 natural oak



no. 776 Charleston oak dark

F foiled front

M Melamine coated front with ABS-edge

carcass colours

* High gloss carcass for an additional price



No. 177 cosmos grey matt



No. 193 titanium grey matt

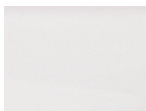

*no. 161 white hgl.



*no. 121 anthracite hgl.



no. 170 Halifax oak



no. 150 cardiff oak



no. 151 Cuneo oak brown



no. 171 Cuneo oak natural



Nr. 185 natural oak



no. 176 Charleston oak dark

Washbasin colours

STONEPLUS washbasins



No. 61
white

Handle version



No. 690 bar handle chrome

handle bore 96 mm / 384 mm /
560 mm / 3x 320 mm

Technique

door with integrated buffered closing

No. 554

**Pull outs and drawers with soft
close**

No. 555







pull-out units and drawer with chrome edge

No. 560

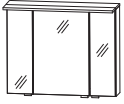

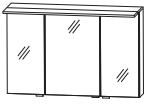

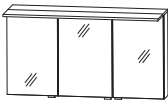

Pull-outs with glass rail and drawer with chrome edge

Washbasin base units with b-collection label

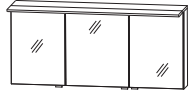

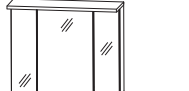

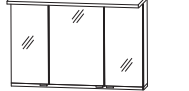
b - cube - model list

Depth indication corresponds to the carcass depth		Depth in mm	Width in mm	Height in mm	Article number	Hinge			
Mirror cabinets Series A									
  incl. handle blocks	mirror cabinet 3 double mirror doors 2 central partitions, 6 glass shelves 1 LED panel light oblong 11,63 watt / Converter 15 watt 954 lumens / (2700 -) 6500 Kelvin 1 switch socket element Door width: 196 mm / 396 mm / 196 mm This product contains a light source with energy efficiency class: F Additional accessories LED washbasin lighting LED washbasin lighting emotion Emotion lighting	150	800	660	S 2 A 4 3 8 0 8 8				
  incl. handle blocks	mirror cabinet 3 double mirror doors 2 central partitions, 6 glass shelves 1 LED panel light oblong 14,73 watt / converter 30 watt 1208 lumens / (2700 -) 6500 Kelvin 1 switch socket element Door width: 296 mm / 396 mm / 296 mm This product contains a light source with energy efficiency class: F Additional accessories LED washbasin lighting LED washbasin lighting emotion Emotion lighting	150	1000	660	S 2 A 4 3 1 0 8 8				
  incl. handle blocks	mirror cabinet 3 double mirror doors 2 central partitions, 6 glass shelves 1 LED panel light oblong 17,8 watt / converter 30 watt 1462 lumens / (2700 -) 6500 Kelvin 1 switch socket element Door width: 388 mm / 412 mm / 388 mm This product contains a light source with energy efficiency class: F Additional accessories LED washbasin lighting LED washbasin lighting emotion Emotion lighting	150	1200	660	S 2 A 4 3 1 2 8 8				

b - cube - model list

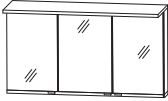

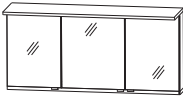
Depth indication corresponds to the carcass depth	Depth in mm	Width in mm	Height in mm	Article number	Hinge	
Mirror cabinets Series A						
  <p>incl. handle blocks</p>	<p>mirror cabinet 3 double mirror doors 2 central partitions, 6 glass shelves 1 LED panel light oblong 20,9 watt / converter 30 watt 1716 lumens / (2700 -) 6500 Kelvin 1 switch socket element Door width: 446 mm / 496 mm / 446 mm This product contains a light source with energy efficiency class: F</p> <p>Additional accessories LED washbasin lighting LED washbasin lighting emotion Emotion lighting</p>	150	1400	660	S 2 A 4 3 1 4 8 8	
Mirror cabinets Series B						
  <p>incl. handle blocks</p>	<p>mirror cabinet 3 double mirror doors 2 central partitions, 6 glass shelves 1 LED panel light above 230 mm deep 1 LED panel light below 150 mm deep per 11,6 watt / 1090 lumens / 2700 - 6500 Kelvin 1 LED converter 30 W Emotion lighting 1 switch socket element Door width: 196 mm / 396 mm / 196 mm This product contains a light source with energy efficiency class: F</p>	150	800	660	S E T 4 3 8 0 B 1	
  <p>incl. handle blocks</p>	<p>mirror cabinet 3 double mirror doors 2 central partitions, 6 glass shelves 1 LED panel light above 230 mm deep 1 LED panel light below 150 mm deep per 14,7 watt / 1382 lumens / 2700 - 6500 Kelvin 1 LED converter 30 W Emotion lighting 1 switch socket element Door width: 296 mm / 396 mm / 296 mm This product contains a light source with energy efficiency class: F</p>	150	1000	660	S E T 4 3 1 0 B 1	

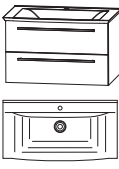
b - cube - model list

Depth indication corresponds to the carcass depth		Depth in mm	Width in mm	Height in mm	Article number	Hinge			
Mirror cabinets Series B									
  incl. handle blocks	mirror cabinet 3 double mirror doors 2 central partitions, 6 glass shelves 1 LED panel light above 230 mm deep 1 LED panel light below 150 mm deep per 17,8 watt / 1673 lumens / 2700 - 6500 Kelvin 1 LED converter 60 W Emotion lighting 1 switch socket element Door width: 388 mm / 412 mm / 388 mm This product contains a light source with energy efficiency class: F	150	1200	660	SET 4 3 1 2 B 1				
  incl. handle blocks	mirror cabinet 3 double mirror doors 2 central partitions, 6 glass shelves 1 LED panel light above 230 mm deep 1 LED panel light below 150 mm deep per 20,9 watt / 1964 lumens / 2700 - 6500 Kelvin 1 LED converter 60 W Emotion lighting 1 switch socket element Door width: 446 mm / 496 mm / 446 mm This product contains a light source with energy efficiency class: F	150	1400	660	SET 4 3 1 4 B 1				
Sets									
	Consisting of: STONEPLUS - washbasin white incl. CLOU drain and overflow system in chrome Washbasin base unit 800 mm 1 metal pull out unit with buffered closing 1 metal pull out unit with buffered closing and rail								
	without LED lighting	545	829	510	SET B G 8 0 6 1				
	with LED lighting 3,8 watt / converter 15 watt 324 lumens / 6500 Kelvin 1 motion sensor This product contains a light source with energy efficiency class: F	545	829	510	SET B G 8 0 B 6				
	Additional accessories Space-saving drain stench trap DN 40 Space-saving drain stench trap DN 32				P Z 1 3 6 7 P Z 1 4 2 3				

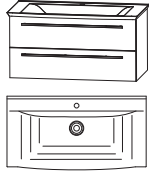

You find information on the the washbasin manufacturer at the beginning of the sales book.

b - cube - model list

Depth indication corresponds to the carcass depth	Depth in mm	Width in mm	Height in mm	Article number	Hinge				
Sets									
	Consisting of: STONEPLUS - washbasin white incl. CLOU drain and overflow system in chrome washbasin base unit 1000 mm 1 metal pull out unit with buffered closing 1 metal pull out unit with buffered closing and rail								
without LED lighting	545	1029	510	SETBG1061					
with LED lighting 4,8 watt / converter 15 watt 410 lumens / 6500 Kelvin 1 motion sensor This product contains a light source with energy efficiency class: F	545	1029	510	SETBG10B6					
Additional accessories Space-saving drain stench trap DN 40 Space-saving drain stench trap DN 32				P Z 1 3 6 7 P Z 1 4 2 3					
	Consisting of: STONEPLUS - washbasin white incl. CLOU drain and overflow system in chrome washbasin base unit 1200 mm 1 metal pull out unit with buffered closing 1 metal pull out unit with buffered closing and rail								
without LED lighting	545	1229	510	SETBG1261					
with LED lighting 5,8 watt / Converter 15 Watt 497 lumens / 6500 Kelvin 1 motion sensor This product contains a light source with energy efficiency class: F	545	1229	510	SETBG12B6					
Additional accessories Space-saving drain stench trap DN 40 Space-saving drain stench trap DN 32				P Z 1 3 6 7 P Z 1 4 2 3					

You find information on the the washbasin manufacturer at the beginning of the sales book.

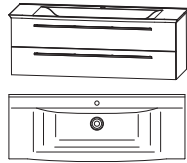
b - cube - model list

Depth indication corresponds to the carcass depth	Depth in mm	Width in mm	Height in mm	Article number		Hinge			
Sets									
	<p>Consisting of: STONEPLUS - washbasin white incl. CLOU drain and overflow system in chrome washbasin base unit 1400 mm 1 metal pull out unit with buffered closing 1 metal pull out unit with buffered closing and rail</p>								
without LED lighting	545	1429	510	S E T B G 1 4 6 1					
<p>with LED lighting with LED lighting 6,7 watt / converter 15 watt 583 lumens / 6500 Kelvin 1 motion sensor This product contains a light source with energy efficiency class: F</p>	545	1429	510	S E T B G 1 4 B 6					
<p>Additional accessories Space-saving drain stench trap DN 40 Space-saving drain stench trap DN 32</p>				P Z	1 3 6 7				
<p>P Z</p>				P Z	1 4 2 3				
	<p>Consisting of: STONEPLUS double washbasin white incl. 2 CLOU drain and overflow systems in chrome Washbasin base unit 2x 700 mm 2 metal pull out units with buffered closing and syphon cut- out 2 metal pull-out units with buffered closing incl. drawer rail</p>								
without LED lighting	545	1429	510	S E T B G 4 D 6 1					
<p>with LED lighting 6,7 watt / converter 15 watt 583 lumens / 6500 Kelvin 1 motion sensor This product contains a light source with energy efficiency class: F</p>	545	1429	510	S E T B G 4 D B 6					
<p>Additional accessories Space-saving drain stench trap DN 40 (order 2 pieces) Space-saving drain stench trap DN 32 (order 2 pieces)</p>				P Z	1 3 6 7				
<p>P Z</p>				P Z	1 4 2 3				

You find information on the the washbasin manufacturer at the beginning of the sales book.

b - cube - model list

Depth indication corresponds to the carcass depth

Tall units - top cover has to be ordered separately

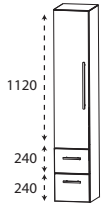
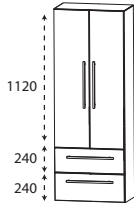
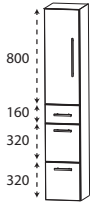
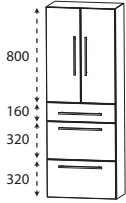
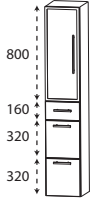
	Depth in mm	Width in mm	Height in mm	Article number	Hinge					
	300	300	1600	HNA0830	4	L/R				
	300	400	1600	HNA0840	4	L/R				
	300	600	1600	HNA0860	4					
	300	300	1600	HNA0930		L/R				
	300	400	1600	HNA0940		L/R				
	300	600	1600	HNA0960						
	300	300	1600	HNA09315M		L/R				

b - cube - model list

Depth indication corresponds to the carcass depth

Tall units - top cover has to be ordered separately

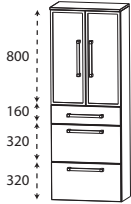
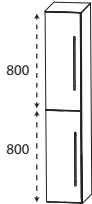
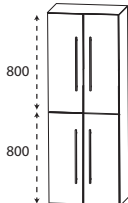
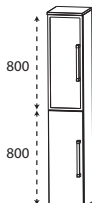
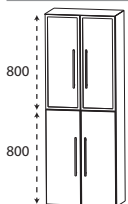
	Depth in mm	Width in mm	Height in mm	Article number	Hinge				
 <p>Tall unit 2 aluminium framed doors with satined glass 2 glass shelves (top) 1 drawer with buffered closing 2 metal pull-outs with buffered closing</p>	300	600	1600	H N A 0 9 6 1 5 M					
 <p>Tall unit 2 doors with buffered closing 2 glass shelves (top) 2 adjustable shelves (bottom)</p> <p>Variable in width: please quote the exact dimension of carcass depth.</p>	300	300	1600	H N A 0 3 3 0	L/R				
	300	400	1600	H N A 0 3 4 0	L/R				
	150-299	300	1600	H V A 0 3 3 0	L/R				
	150-299	400	1600	H V A 0 3 4 0	L/R				
 <p>Tall unit 4 door with buffered closing 2 glass shelves (top) 2 adjustable shelves (bottom)</p> <p>Variable in width: please quote the exact dimension of carcass depth.</p>	300	600	1600	H N A 0 3 6 0					
	150-299	600	1600	H V A 0 3 6 0					
 <p>Tall unit 1 aluminium framed door with satined glass 2 glass shelves (top) 1 door with buffered closing 2 adjustable shelves (bottom)</p> <p>Variable in width: please quote the exact dimension of carcass depth.</p>	300	300	1600	H N A 0 3 3 1	5 L/R				
	150-299	300	1600	H V A 0 3 3 1	L/R				
 <p>Tall unit 2 aluminium framed doors with satined glass 2 glass shelves (top) 2 doors with buffered closing 2 adjustable shelves (bottom)</p> <p>Variable in width: please quote the exact dimension of carcass depth.</p>	300	600	1600	H N A 0 3 6 1	5				
	150-299	600	1600	H V A 0 3 6 1					

b - cube - model list

Depth indication corresponds to the carcass depth

Tall units - top cover has to be ordered separately

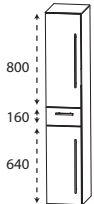
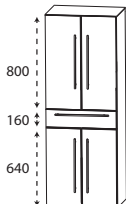
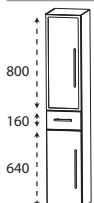
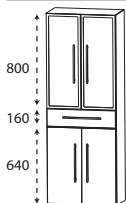
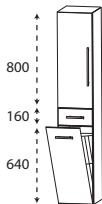

	Depth in mm	Width in mm	Height in mm	Article number	Hinge					
 <p>Tall unit 1 door with buffered closing 2 glass shelves (top) 1 drawer with buffered closing 1 door with buffered closing 1 glass shelf</p>	300	300	1600	HNA 0 5 3 0	L/R					
	300	400	1600	HNA 0 5 4 0	L/R					
 <p>Tall unit 2 doors with buffered closing 2 glass shelves (top) 1 drawer with buffered closing 2 doors with buffered closing 1 glass shelf</p>	300	600	1600	HNA 0 5 6 0						
 <p>Tall unit 1 aluminium framed door with buffered closing 2 glass shelves (top) 1 drawer with buffered closing 1 door with buffered closing 1 glass shelf</p>	300	300	1600	HNA 0 5 3 1	L/R					
 <p>Tall unit 2 aluminium framed doors with buffered closing 2 glass shelves (top) 1 drawer with buffered closing 2 doors with buffered closing 1 glass shelf</p>	300	600	1600	HNA 0 5 6 1						
 <p>Tall unit with laundry basket 1 door with buffered closing 2 glass shelves 1 drawer with buffered closing 1 laundry basket with wire basket</p> <p>Volume of laundry basket: 25 liters</p> <p>Volume of laundry basket: 35 liters</p>	300	300	1600	HNA 0 5 3 0	W L/R					
	300	400	1600	HNA 0 5 4 0	W L/R					

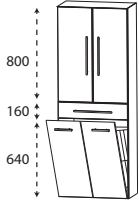
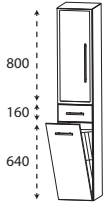
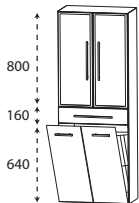
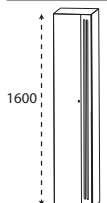
b - cube - model list

Depth indication corresponds to the carcass depth		Depth in mm	Width in mm	Height in mm	Article number	Hinge				
Tall units - top cover has to be ordered separately										
	<p>Tall unit with laundry basket 2 doors with buffered closing 2 glass shelves 1 drawer with buffered closing 1 laundry basket with wire basket</p> <p>Volume of laundry basket: 55 liters</p>	300	600	1600	H N A 0 5 6 0	W				
	<p>Tall unit with laundry basket 1 aluminium framed door with satined glass 2 glass shelves 1 drawer with buffered closing 1 laundry basket with wire basket</p> <p>Volume of laundry basket: 25 liters</p>	300	300	1600	H N A 0 5 3 1	W L/R				
	<p>Tall unit with laundry basket 2 aluminium framed doors with satined glass 2 glass shelves 1 drawer with buffered closing 1 laundry basket with wire basket</p> <p>Volume of laundry basket: 55 liters</p>	300	600	1600	H N A 0 5 6 1	W				
	<p>Tall unit 1 double mirror door with buffered closing 1 mirror panel incl. LED lighting 14,4 Watt 1220 lumens / 2700 - 6500 Kelvin 4 glass shelves 1 fixed shelf incl. converter 15 Watt and sensor switch element This product contains a light source with energy efficiency class: F</p> <p>Variable in width: please quote the exact dimension of carcass depth.</p>	300	400	1600	H N A 0 1 4 0	1 L/R				
		150-299	400	1600	H V A 0 1 4 0	1 L/R				

b - cube - model list

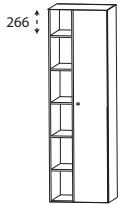
Depth indication corresponds to the carcass depth

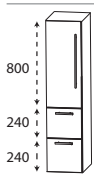
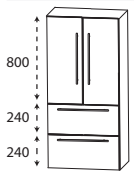
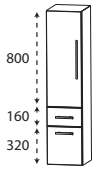
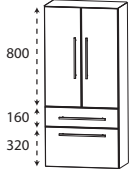
	Depth in mm	Width in mm	Height in mm	Article number	Hinge				
Tall units - top cover has to be ordered separately									
  Ill. = right	300	500	1600	R H N 0 1 5 0 0 1	L/R				
Tall unit 1 double mirror door 6 glass shelves 1 shelf 5 shelves mirrored back side 26,9 watt / converter 30 watt 2959 lumens / 3000 - 6500 Kelvin with sensor for emotion lighting This product contains a light source with energy efficiency class: F									
Central units top cover has to be ordered separately									
	300	300	1280	M N A 8 7 3 0	4	L/R			
	300	400	1280	M N A 8 7 4 0	4	L/R			
medium-high unit 1 door with buffered closing 2 glass shelves 2 metal pull-outs with buffered closing									
	300	600	1280	M N A 8 7 6 0	4				
medium-high unit 2 doors with buffered closing 2 glass shelves 2 metal pull-outs with buffered closing									
	300	300	1280	M N A 8 8 3 0		L/R			
	300	400	1280	M N A 8 8 4 0		L/R			
medium-high unit 1 door with buffered closing 2 glass shelves (top) 1 drawer with buffered closing 1 metal pull-out with buffered closing,									
	300	600	1280	M N A 8 8 6 0					
medium-high unit 2 doors with buffered closing 2 glass shelves (top) 1 drawer with buffered closing 1 metal pull-out with buffered closing,									

b - cube - model list

Depth indication corresponds to the carcass depth

Central units - top cover has to be ordered separately

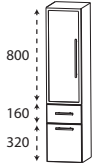
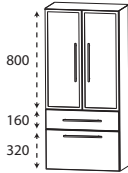
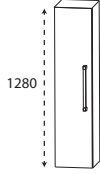
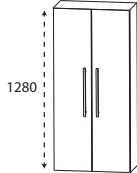
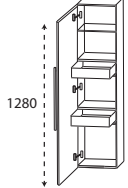
	Depth in mm	Width in mm	Height in mm	Article number	Hinge				
 <p>medium-high unit 1 aluminium framed door with satined glass 2 glass shelves (top) 1 drawer with buffered closing 1 metal pull-out with buffered closing,</p>	300	300	1280	M N A 8 8 3 1 5 M	L/R				
 <p>medium-high unit 2 aluminium framed doors with satined glass 2 glass shelves (top) 1 drawer with buffered closing 1 metal pull-out with buffered closing,</p>	300	600	1280	M N A 8 8 6 1 5 M					
 <p>medium-high unit 1 door with buffered closing 4 glass shelves</p> <p>Variable in width: please quote the exact dimension of carcass depth.</p>	300 300 150-299 150-299	300 400 300 400	1280 1280 1280 1280	M N A 8 1 3 0 M N A 8 1 4 0 M V A 8 1 3 0 M V A 8 1 4 0	7 L/R 7 L/R L/R L/R				
 <p>medium-high unit 2 doors with buffered closing 4 glass shelves</p> <p>Variable in width: please quote the exact dimension of carcass depth.</p>	300 150-299	600 600	1280 1280	M N A 8 1 6 0 M V A 8 1 6 0	7				
 <p>medium-high unit with inside drawer 1 door with buffered closing 2 inside metal- drawers with buffered closing 1 glass shelf</p>	300 300	300 400	1280 1280	M N A 8 4 3 0 M N A 8 4 4 0	L/R L/R				



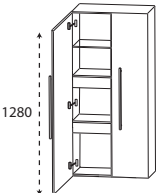
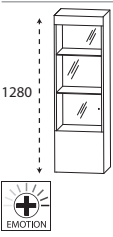
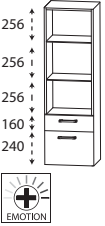
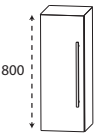



b - cube - model list

Depth indication corresponds to the carcass depth		Depth in mm	Width in mm	Height in mm	Article number	Hinge				
Central units - top cover has to be ordered separately										
	medium-high unit with inside drawer 2 doors with buffered closing 1 continuous glass shelf 2 continuously inside metal-drawer with buffered closing	300	600	1280	MNA 8 4 6 0					
	medium-high unit - display cabinet 1 white printed glass door, with buffered closing 2 LED glass shelves 2 x 0,8 watt 2 x 27 lumens / (3000 -) 6500 Kelvin 1 fixed shelf 1 glass shelf incl. sensor switcher incl. converter 15 Watt This product contains a light source with energy efficiency class: F Additional accessories Emotion lighting	300	400	1280	MNA 8 1 4 0 8 G	L/R				
	medium-high unit 2 LED glass shelves 2 x 0,8 watt 2 x 27 lumens / (3000 -) 6500 Kelvin 1 drawer with buffered closing 1 metal pull out unit with buffered closing and rail incl. converter 15 Watt incl. sensor switcher This product contains a light source with energy efficiency class: F Additional accessories Emotion lighting	300	400	1280	MNA 8 8 4 0 8					
Highboards										
top cover has to be ordered separately										
	Highboard 1 door with buffered closing 2 glass shelves Variable in width: please quote the exact dimension of carcass depth.	300 300 150-299 150-299	300 400 300 400	800 800 800 800	HBA 5 1 3 0 HBA 5 1 4 0 HBVA 5 1 3 HBVA 5 1 4	L/R L/R L/R L/R				

b - cube - model list

Depth indication corresponds to the carcass depth



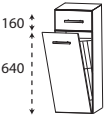
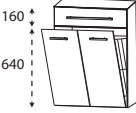
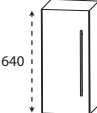
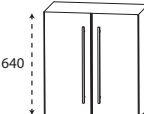
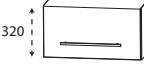
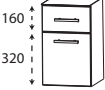

Highboards - top cover has to be ordered separately

	Depth in mm	Width in mm	Height in mm	Article number	Hinge				
 <p>800</p>	300	600	800	H B A 5 1 6 0					
	150-299	600	800	H B V A 5 1 6	1				
 <p>800</p>	300	300	800	H B A 5 1 3 1	L/R				
	150-299	300	800	H B V A 5 1 3	1	L/R			
 <p>800</p>	300	600	800	H B A 5 1 6 1					
	150-299	600	800	H B V A 5 1 6	1				
 <p>160 320 320</p>	300	300	800	H B A 5 6 3 0					
	300	400	800	H B A 5 6 4 0					
 <p>160 320 320</p>	300	600	800	H B A 5 6 6 0					
 <p>160 640</p>	300	300	800	H B A 5 5 3 0	L/R				
	300	400	800	H B A 5 5 4 0	L/R				
 <p>160 640</p>	300	600	800	H B A 5 5 6 0					

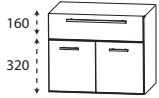

b - cube - model list

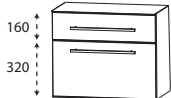
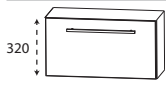
Depth indication corresponds to the carcass depth		Depth in mm	Width in mm	Height in mm	Article number	Hinge				
Highboards - top cover has to be ordered separately										
 <p>160 640</p>	Highboard with laundry basket 1 drawer with buffered closing 1 laundry basket with wire basket									
	Volume of laundry basket: 25 liters	300	300	800	H B A 5 5 3 0	W				
	Volume of laundry basket: 35 liters	300	400	800	H B A 5 5 4 0	W				
 <p>160 640</p>	Highboard with laundry basket 1 drawer with buffered closing 1 laundry basket with wire basket									
	Volume of laundry basket: 55 liters	300	600	800	H B A 5 5 6 0	W				
Wall units - top cover has to be ordered separately										
 <p>640</p>	Wall unit 1 door with buffered closing 1 glass shelf	150	300	640	O G A 4 1 3 0	L/R				
		150	400	640	O G A 4 1 4 0	L/R				
	Variable in width: please quote the exact dimension of carcass depth.	151-300	300	640	O V A 4 1 3 0	L/R				
		151-300	400	640	O V A 4 1 4 0	L/R				
 <p>640</p>	Wall unit 2 doors with buffered closing 1 glass shelf	150	600	640	O G A 4 1 6 0					
	Variable in width: please quote the exact dimension of carcass depth.	151-300	600	640	O V A 4 1 6 0					
 <p>320</p>	Wall unit 1 flap door,	230	600	320	O M A 2 1 6 0	K				
Base units - top cover has to be ordered separately										
 <p>160 320</p>	Base unit 1 drawer with buffered closing 1 door with buffered closing	300	300	480	U N A 3 2 3 0	L/R				
			300	400	480	U N A 3 2 4 0	L/R			

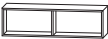

b - cube - model list

Depth indication corresponds to the carcass depth		Depth in mm	Width in mm	Height in mm	Article number	Hinge				
Base units - top cover has to be ordered separately										
	Base unit 1 drawer with buffered closing 2 doors with buffered closing	300	600	480	U N A 3 2 6 0					
	Base unit 1 drawer with buffered closing 1 metal pull-out with buffered closing,	300 300	300 400	480 480	U N A 3 4 3 0 U N A 3 4 4 0					
	Base unit 1 drawer with buffered closing 1 metal pull-out with buffered closing,	300	600	480	U N A 3 4 6 0					
	Base unit 1 flap door,	230	600	320	U M A 2 1 6 0	K				
Counter tops										
	top cover with ABS edge in carcass colour									
	302 mm width Standard depth	330	302	28	A P A 3 3 3 0 2 8					
	402 mm width Standard depth	330	402	28	A P A 3 3 4 0 2 8					
	602 mm width Standard depth	330	602	28	A P A 3 3 6 0 2 8					
	302 mm width Standard depth Wall unit	180	302	28	A P A 1 8 3 0 2 8					
	402 mm width Standard depth Wall unit	180	402	28	A P A 1 8 4 0 2 8					
	602 mm width Standard depth Wall unit	180	602	28	A P A 1 8 6 0 2 8					
	402 mm width Standard depth HNA 0140 1 / MNA 8140 8G / MNA 8840 8	310	402	28	A P A 3 1 4 0 2 8					
	502 mm width RHN 0150 01	310	502	28	A P A 3 1 5 0 2 8					
	602 mm width Flap cabinet	260	602	28	A P A 2 6 6 0 2 8					
	adjustable in depth und width Price per metre	145-495	300-2600	28	A P N 6 0 V 2 8					

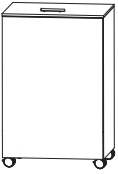





b - cube - model list

Depth indication corresponds to the carcass depth		Depth in mm	Width in mm	Height in mm	Article number	Hinge					
Shelves											
	<p>functional shelf Edges are cut with a mitre vertical and horizontal mounting possible</p> <p>please indicate colour version: no. 501 white matt lacquered no. 547 black matt lacquered</p>	150	300	160	RGL 1 1 3 0 0 1						
	<p>functional shelf Edges are cut with a mitre vertical and horizontal mounting possible</p> <p>please indicate colour version: no. 501 white matt lacquered no. 547 black matt lacquered</p>	150	600	160	RGL 1 1 6 0 0 2						
	<p>functional shelf Edges are cut with a mitre vertical and horizontal mounting possible</p> <p>please indicate colour version: no. 501 white matt lacquered no. 547 black matt lacquered</p>	150	900	160	RGL 1 1 9 0 0 3						
Laundryrolli											
	<p>Laundryrolli 1 flap door, with buffered closing 1 take-out laundry-bag, washable 4 roles Colour version corresponds to the carcass colour</p> <p>incl. height indication rolls (100 mm)</p>	470	470	756	WRS 4 0 4 7						





b - cube - model list

Depth indication corresponds to the carcass depth	Depth in mm	Width in mm	Height in mm	Article number	Hinge
Glass shelves					
 <p>Glass shelf incl. metal holder</p> <p>400 mm wide incl. 2 metal brackets</p> <p>600 mm wide incl. 2 metal brackets</p> <p>800 mm wide incl. 2 metal brackets</p> <p>1000 mm wide incl. 3 metal brackets</p> <p>1200 mm wide incl. 3 metal brackets</p> <p>1400 mm wide incl. 4 metal brackets</p>					
	130	400	8	ABG 1 3 4 0 0 8	
	130	600	8	ABG 1 3 6 0 0 8	
	130	800	8	ABG 1 3 8 0 0 8	
	130	1000	8	ABG 1 3 1 0 0 8	
	130	1200	8	ABG 1 3 1 2 0 8	
	130	1400	8	ABG 1 3 1 4 0 8	
Push- fit shelf					
 <p>Push- fit shelf with ABS thick edge all around incl. holders for push fit shelf</p> <p>300 mm wide incl. 2 push-fit holder</p> <p>400 mm wide incl. 2 push-fit holder</p> <p>600 mm wide incl. 2 push-fit holder</p> <p>800 mm wide incl. 3 push-fit holder</p> <p>1000 mm wide incl. 3 push-fit holder</p> <p>1200 mm wide incl. 3 push-fit holder</p> <p>1400 mm wide incl. 3 push-fit holder</p>					
	150	300	28	SBG 6 0 3 0	
	150	400	28	SBG 6 0 4 0	
	150	600	28	SBG 6 0 6 0	
	150	800	28	SBG 6 0 8 0	
	150	1000	28	SBG 6 0 1 0	
	150	1200	28	SBG 6 0 1 2	
	150	1400	28	SBG 6 0 1 4	



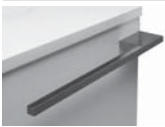





b - cube - model list

Depth indication corresponds to the carcass depth	Depth in mm	Width in mm	Height in mm	Article number			Hinge						
Accessories													
	decor panel with chrome edge no. 129 chrome angled to fit underneath washbasin base units:												
	487	794	12	DB	4 9 8 0 1 2								
	487	994	12	DB	4 9 1 0 1 2								
	487	1194	12	DB	4 9 1 2 1 2								
	487	1394	12	DB	4 9 1 4 1 2								
	decor panel with chrome edge no. 129 chrome angled to fit underneath furniture elements												
	317	294	12	DB	3 1 3 0 1 2								
	317	394	12	DB	3 1 4 0 1 2								
	300	394	12	DB	3 0 4 0 1 2								
	297	494	12	DB	2 9 5 0 1 2								
	317	594	12	DB	3 1 6 0 1 2								
	Towel holder one-armed front opened for assembling at the washbasin base unit Please observe carcass depth and furniture height												
	390	55	30	P Z	1 1 2 8 1 1								
	390	55	30	P Z	1 1 2 8 1 2								
	Towel holder two-armed front opened for assembling at the washbasin base unit Please observe carcass depth and furniture height												
	390	110	30	P Z	1 1 2 8 1								
	390	110	30	P Z	1 1 2 8 2								
	Towel holder one-armed swiveling for mounting to wall or carcass Please observe carcass depth and furniture height												
	420	30	46	P Z	1 1 4 7 1								
	420	30	46	P Z	1 1 4 7 2								
	Towel holder one-armed extendable chrome gloss wall-mounted												
	330-567	44	44	P Z	1 1 3 7 1								









b - cube - model list

Depth indication corresponds to the carcass depth		Depth in mm	Width in mm	Height in mm	Article number			Hinge				
Accessories												
	Towel holder two-armed extendable chrome gloss wall-mounted	322-562	87	47	P Z	1 1 3 7	2					
	Towel holder chrome gloss to fit on carcass at side front opened Please observe carcass depth and furniture height	390	60		P Z	1 1 2 4	1					
	Mirror handle for mirror cabinet door Chrome hgl. for sticking on double mirrored doors Please order one mirror handle per door!				P Z	1 1 2 5						
	Adjustable organizer components not possible for variant 560 2 dividing elements - 300 mm cabinet width 3 dividing elements - 400 mm cabinet width 4 dividing elements - 600 mm cabinet width 4 dividing elements - 700 mm cabinet width 4 dividing elements - 800 mm cabinet width 5 dividing elements - 1000 mm cabinet width 6 dividing elements- 1200 mm cabinet width 7 dividing elements - 1400 mm cabinet width				P Z	1 2 2 4 3 0						
					P Z	1 2 2 4 4 0						
					P Z	1 2 2 4 6 1						
					P Z	1 2 2 4 7 0						
					P Z	1 2 2 4 8 0						
					P Z	1 2 2 4 1 0						
					P Z	1 2 2 4 1 2						
					P Z	1 2 2 4 1 4						
	Basin organizer without fitting elements	150	246	150	P Z	1 2 3 6 E 1						

b - cube - model list

Depth indication corresponds to the carcass depth		Depth in mm	Width in mm	Height in mm	Article number		Hinge						
Accessories													
	Basin organizer incl. fixing elements not possible for variant 560 2 basin organizer for 600 mm carbinet width 2 basin organizer for 700 mm carbinet width 2 basin organizer for 800 mm carbinet width 2 basin organizer for 1000 mm carbinet width 2 basin organizer for 1200 mm carbinet width 2 basin organizer for 1400 mm carbinet width				P Z	1 2 3 6 6 0							
					P Z	1 2 3 6 7 0							
					P Z	1 2 3 6 8 0							
					P Z	1 2 3 6 1 0							
					P Z	1 2 3 6 1 2							
					P Z	1 2 3 6 1 4							
	Drawer set for metal drawers Consisting of: - 1 aluminium-coloured plastic insert - 2 aluminium coloured dividers, adjustable for 30 cm wide cabinets for 40 cm width units				P Z	1 2 2 5 3 0							
					P Z	1 2 2 5 4 0							
	USB socket element 2 plus-in slots connection 220 V with clamp installed in mirror cabinet please state position not installed in mirror cabinet	45	80	64	P Z	1 1 5 1 E B							
		45	80	64	P Z	1 1 5 1 1							
 	LED washbasin lighting emotion 2,6 Watt / 187 lumens / (2700 -) 6500 Kelvin 1 switch element IED converter This product contains a light source with energy efficiency class: G LED mood lighting available as an option	16	560	7	P Z	1 1 5 0 6 0							
 	LED washbasin lighting emotion 4,0 Watt / 287 lumens / (2700 -) 6500 Kelvin 1 switch element IED converter This product contains a light source with energy efficiency class: G LED mood lighting available as an option	16	860	7	P Z	1 1 5 0 9 0							
 	LED washbasin lighting emotion 5,4 watt / 388 lumens / (2700 -) 6500 Kelvin 1 switch element IED converter This product contains a light source with energy efficiency class: G LED mood lighting available as an option	16	1160	7	P Z	1 1 5 0 1 2							

b - cube - model list

Depth indication corresponds to the carcass depth		Depth in mm	Width in mm	Height in mm	Article number			Hinge				
Accessories												
	<p>LED washbasin lighting 2,4 Watt / 168 lumens / 6500 Kelvin 1 switch element to fit underneath mirror cabinet This product contains a light source with energy efficiency class: G</p> <p>not suitable with Emotion lighting</p>	10	560	10	P Z	1 0 6 3 6 0						
	<p>LED washbasin lighting 3,9 Watt / 287 lumens / 6500 Kelvin 1 switch element to fit underneath mirror cabinet This product contains a light source with energy efficiency class: G</p> <p>not suitable with Emotion lighting</p>	10	860	10	P Z	1 0 6 3 9 0						
	<p>LED washbasin lighting 5,3 Watt / 371 lumens / 6500 Kelvin 1 switch element to fit underneath mirror cabinet This product contains a light source with energy efficiency class: G</p> <p>not suitable with Emotion lighting</p>	10	1160	10	P Z	1 0 6 3 1 2						
	<p>Emotion lighting sensor switcher for dimming and for colour change control</p> <p>for all identified cabinets</p>				P Z	1 0 2 0 1						
												
	<p>Motion sensor for LED lighting of washbasins or washbasin base units Term and sensitivity of lighting are adjustable</p>				P Z	1 1 4 1						
	<p>Remote switch incl. receiver for LED lighting for dimming and for colour change control Reach up to 5 meters</p> <p>not suitable for LED converter over 30 watt</p>		85	85	P Z	1 1 4 3						
	<p>Space-saving drain stench trap from GEBERIT made of plastic, in white nominal diameter: 40</p>				P Z	1 3 6 7						
	<p>Space-saving drain stench trap from GEBERIT made of plastic, in white nominal diameter: 32</p>				P Z	1 4 2 3						

b - cube - dimensional drawings

SET BG80 61/B6

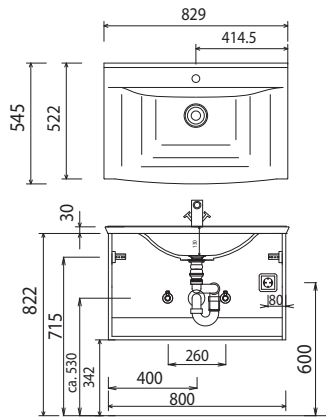

SET BG10 61/B6

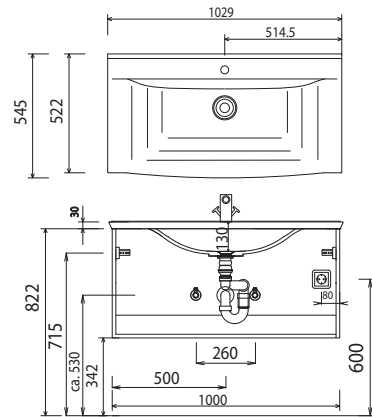

SET BG12 61/B6

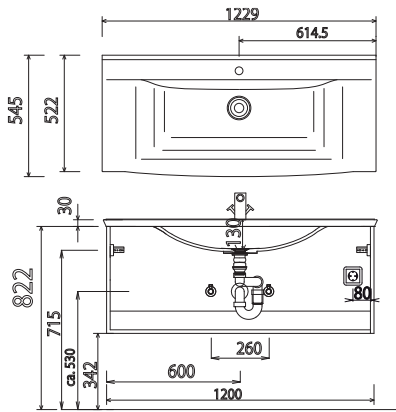

SET BG14 61/B6

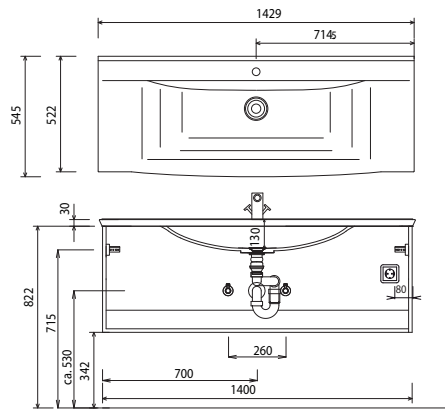

SET BG4D 61/B6

electrical connections for mirror cabinets

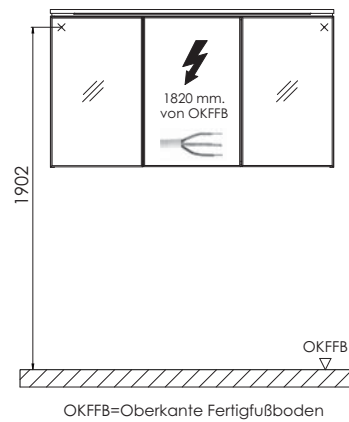
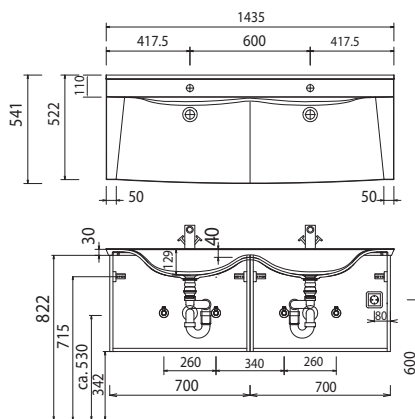

Washing stands without anchoring brackets have to be fixed on the wall and on the furniture-side with silicon!

STONEPLUS:

The water temperature must not exceed 55° C / 131° F. Hair tinting lotions have to be removed in a few seconds, so that staining can be avoided.

Modifications:

Technical modifications (+/- 5mm) and flatness modifications (DIN 18202) are subject of the usual material-specific modifications for construction materials, based on DIN 18202.