



Front colours



No. 793 noble white matt



No. 722 polar white hgl.



no. 670 Halifax oak



No. 750 cardiff oak



no. 751 Cuneo oak brown



no. 771 Cuneo oak natural

F foiled front

M Melamine coated front with ABS-edge

carcass colours

* High gloss carcass for an additional price

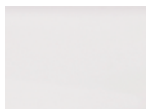

No. 111
white matt

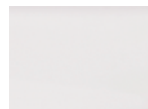

no. 161
high-gloss white



no. 170
Halifax oak



no. 150
cardiff oak



no. 151
Cuneo oak brown



no. 171 Cuneo oak
natural

Washbasin colours

washbasin



No. 21
white **evermite**[®]

Handle version



No. 331 Stainless steel handle

handle bore 320 mm

Technique

door with integrated buffered closing

No. 554
Pull-outs and drawers with soft close

optional:

No. 555
pull-out units and drawer with chrome edge

No. 560
Pull-outs with glass rail and drawer with chrome edge

Washbasin base units with b-collection label







Illustrations and specifications are without obligation. Technical modifications reserved.

Bm.2

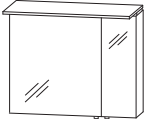

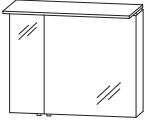

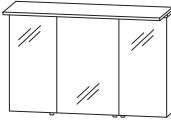
2022/2023 - ID

Please note the instruction for warranty, mounting and care, and the quality agreements as well, at the beginning of the book.

b - maxx - model list

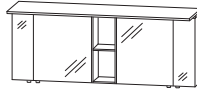



Depth indication corresponds to the carcass depth		Depth in mm	Width in mm	Height in mm	Article number				
  <p>mirror cabinet 2 double mirror doors 1 flyover shelf with LED lighting 4,3 watt / converter 15 watt 378 lumens / (2700 -) 6500 Kelvin 1 middle panel 2 glass shelves 1 switch socket element Door width: 546 mm / 196 mm This product contains a light source with energy efficiency class: E</p> <p>Additional accessories LED washbasin lighting LED washbasin lighting emotion Emotion lighting</p>		150	752	668	SBC 4 L 7 5 0 1				
  <p>mirror cabinet 2 double mirror doors 1 flyover shelf with LED lighting 4,3 watt / converter 15 watt 378 lumens / (2700 -) 6500 Kelvin 1 middle panel 2 glass shelves 1 switch socket element Door width: 196 mm / 546 mm This product contains a light source with energy efficiency class: E</p> <p>Additional accessories LED washbasin lighting LED washbasin lighting emotion Emotion lighting</p>		150	752	668	SBC 4 R 7 5 0 1				
  <p>mirror cabinet 3 double mirror doors 1 flyover shelf with LED lighting 5,1 watt / converter 15 watt 449 lumens / (2700 -) 6500 Kelvin 1 middle panel 2 central partitions, 6 glass shelves 1 switch socket element Door width: 296 mm / 396 mm / 296 mm This product contains a light source with energy efficiency class: E</p> <p>Additional accessories LED washbasin lighting LED washbasin lighting emotion Emotion lighting</p>		150	1002	668	SBC 4 1 1 0 0 1				

b - maxx - model list

Depth indication corresponds to the carcass depth	Depth in mm	Width in mm	Height in mm	Article number	Hinge
Mirror cabinets					
	150	1702	668	SBC 4 1 1 7 0 1	
					
<p>Mirror cabinet- Set consisting of 2 mirror cabinets à 2 double mirror doors 2 glass shelves 1 switch socket element 1 shelf 200 mm width 1 fixed shelf flyover shelf with LED lighting 2 x 4,3 watt / 2 x converter 15 watt 2 x 378 lumens / (2700 -) 6500 Kelvin 1 middle panel Door width: 196 mm / 546 mm - 546 mm / 196 mm This product contains a light source with energy efficiency class: E</p> <p>Shelf and shelf backplane available in different colors please indicate colours version</p> <p>Additional accessories LED washbasin lighting (please order 2 pieces) LED washbasin lighting emotion (please order 2 pieces) Emotion lighting (please order 2 pieces)</p>	PZ 1 0 6 3 60	PZ 1 1 5 0 60	PZ 1 0 2 0 1		
evermite - washbasins					
					
					
<p>Evermite washbasin colour white inkl. concealed overflow system chrome finish</p> <p>without LED lighting 556 762 40 WMS 7 5 1 2 2 1</p> <p>with LED lighting 556 762 40 SWM 7 5 1 2 B 2</p> <p>1 LED converter 12 V, 15 Watt 281 lumens / 6500 Kelvin integrated sensor switcher This product contains a light source with energy efficiency class: F</p> <p>can be combined with WUA 3275 03, WUA 3375 05, WUA 3375 06</p> <p>Additional accessories motion sensor for LED lighting</p>	PZ 1 1 4 1				

You find information on the the washbasin manufacturer at the beginning of the sales book.

b - maxx - model list

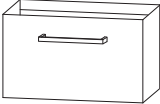
Depth indication corresponds to the carcass depth		Depth in mm	Width in mm	Height in mm	Article number	Hinge				
evermite - washbasins										
 	Evermite washbasin colour white inkl. concealed overflow system chrome finish									
	without LED lighting with LED lighting 1 LED converter 12 V, 15 Watt 410 lumens / 6500 Kelvin integrated sensor switcher This product contains a light source with energy efficiency class: F can be combined with WUA 3210 03, WUA 3310 05, WUA 3310 06 Additional accessories motion sensor for LED lighting	556	1012	40	WMS 1 0 1 2 2 1					
		556	1012	40	SWM 1 0 1 2 B 2					
					P Z 1 1 4 1					
 	Evermite double washbasin colour white inkl. 2 concealed overflow systems chrome finish									
	without LED lighting with LED lighting 1 LED converter 12 V, 15 Watt 711 lumens / 6500 Kelvin integrated sensor switcher This product contains a light source with energy efficiency class: F can be combined with WUA 3217 03, WUA 3317 05, WUA 3317 06 Additional accessories motion sensor for LED lighting	556	1712	40	WMS 1 7 1 2 2 1					
		556	1712	40	SWM 1 7 1 2 B 2					
					P Z 1 1 4 1					
Washbasin base units										
	Washbasin base unit 1 metal pull-out with buffered closing incl. drawer rail	470	750	480	WUA 3 2 7 5 0 3					
	Washbasin base unit Description as above, though inkl. 1 inside drawer with buffered closing with syphon cut- out Additional accessories Space-saving drain stench trap DN 40 Space-saving drain stench trap DN 32	470	750	480	WUA 3 3 7 5 0 5					
					P Z 1 3 6 7					
					P Z 1 4 2 3					

You find information on the the washbasin manufacturer at the beginning of the sales book.

b - maxx - model list

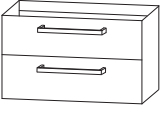
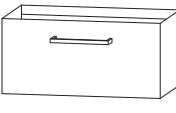
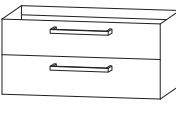
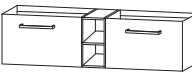
Depth indication corresponds to the carcass depth		Depth in mm	Width in mm	Height in mm	Article number	Hinge				
Washbasin base units										
	Washbasin base unit 1 metal pull out unit with buffered closing 1 aluminium-coloured plastic insert 1 metal pull-out with buffered closing incl. drawer rail Additional accessories Space-saving drain stench trap DN 40 Space-saving drain stench trap DN 32	470	750	480	WUA 3 3 7 5 0 6					
					P Z 1 3 6 7 P Z 1 4 2 3					
	Washbasin base unit 1 metal pull-out with buffered closing incl. drawer rail	470	1000	480	WUA 3 2 1 0 0 3					
	Washbasin base unit Description as above, though inkl. 1 inside drawer with buffered closing with syphon cut- out Additional accessories Space-saving drain stench trap DN 40 Space-saving drain stench trap DN 32	470	1000	480	WUA 3 3 1 0 0 5					
					P Z 1 3 6 7 P Z 1 4 2 3					
	Washbasin base unit 1 metal pull out unit with buffered closing 1 aluminium-coloured plastic insert 1 metal pull-out with buffered closing incl. drawer rail Additional accessories Space-saving drain stench trap DN 40 Space-saving drain stench trap DN 32	470	1000	480	WUA 3 3 1 0 0 6					
					P Z 1 3 6 7 P Z 1 4 2 3					
	Washbasin base unit 2 Washbasin base units (750 mm + 750 mm) 2 metal pull outs with buffered closing and rail 1 shelf 200 mm	470	1700	480	WUA 3 2 1 7 0 3					
	Washbasin base unit Description as above, though inkl. 2 inside drawer with buffered closing and 2 syphon cut- outs Shelf and shelf backplane available in different colors please indicate carcass colours Additional accessories Space-saving drain stench trap DN 40 (order 2 pieces) Space-saving drain stench trap DN 32 (order 2 pieces)	470	1700	480	WUA 3 3 1 7 0 5					
					P Z 1 3 6 7 P Z 1 4 2 3					

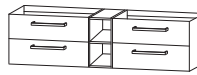
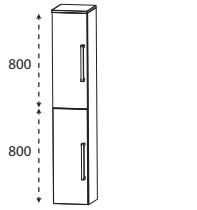
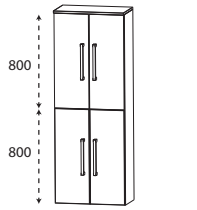

b - maxx - model list

Depth indication corresponds to the carcass depth	Depth in mm	Width in mm	Height in mm	Article number	Hinge	Surcharge glass
Washbasin base units						
	470	1700	480	W U A 3 3 1 7 0 6		
<p>Washbasin base unit 2 Washbasin base units (750 mm + 750 mm) 2 metal pull out units with buffered closing and syphon cut- out per 1 aluminium-coloured plastic insert 2 metal pull outs with buffered closing and rail 1 shelf 200 mm</p> <p>Shelf and shelf backplane available in different colors please indicate colours version</p> <p>Additional accessories Space-saving drain stench trap DN 40 (order 2 pieces) Space-saving drain stench trap DN 32 (order 2 pieces)</p>						
P Z 1 3 6 7						
P Z 1 4 2 3						
Tall units						
	300	300	1628	H N A 0 3 3 B C 1	L/R	
<p>Tall unit 2 doors with buffered closing 2 glass shelves (top) 2 adjustable shelves (bottom) 1 top cover 330 mm deep</p>						
300						
400						
1628						
H N A 0 3 4 B C 1						
L/R						
<p>Colour version of top cover corresponds to the front finish colour</p>						
	300	600	1628	H N A 0 3 6 B C 1		
<p>Tall unit 4 door with buffered closing 2 glass shelves (top) 2 adjustable shelves (bottom) 1 top cover 330 mm deep</p>						
<p>Colour version of top cover corresponds to the front finish colour</p>						

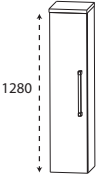
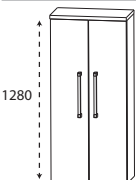
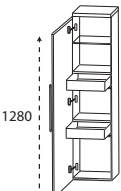
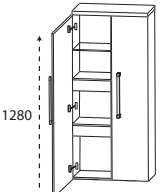
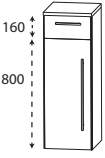

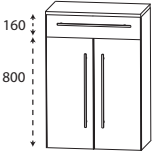
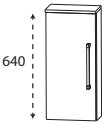
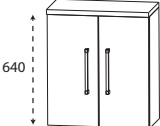

b - maxx - model list

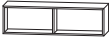
Depth indication corresponds to the carcass depth		Depth in mm	Width in mm	Height in mm	Article number	Hinge				
Central units										
	medium-high unit 1 door with buffered closing 4 glass shelves 1 top cover 330 mm deep Colour version of top cover corresponds to the front finish colour	300	300	1308	MNA 8 1 3 B C 1	L/R				
		300	400	1308	MNA 8 1 4 B C 1	L/R				
	medium-high unit 2 doors with buffered closing 4 glass shelves 1 top cover 330 mm deep Colour version of top cover corresponds to the front finish colour	300	600	1308	MNA 8 1 6 B C 1					
	medium-high unit with inside drawer 1 door with buffered closing 1 glass shelf 2 inside drawers with buffered closing 1 top cover 330 mm deep Colour version of top cover corresponds to the front finish colour	300	300	1308	MNA 8 4 3 B C 1	L/R				
		300	400	1308	MNA 8 4 4 B C 1	L/R				
	medium-high unit with inside drawer 2 doors with buffered closing 1 continuous glass shelf 2 continuously inside metal-drawer with buffered closing 1 top cover 330 mm deep Colour version of top cover corresponds to the front finish colour	300	600	1308	MNA 8 4 6 B C 1					
Highboards										
	Highboard 1 metal pull-out with buffered closing 1 door with buffered closing 2 glass shelves 1 top cover 330 mm deep Colour version of top cover corresponds to the front finish colour	300	300	988	HBA 6 5 3 B C 1	L/R				
		300	400	988	HBA 6 5 4 B C 1	L/R				



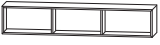



b - maxx - model list

Depth indication corresponds to the carcass depth	Depth in mm	Width in mm	Height in mm	Article number	Hinge
Highboards					
 <p>Highboard 1 metal pull-out with buffered closing 2 doors with buffered closing 2 glass shelves 1 top cover 330 mm deep</p> <p>Colour version of top cover corresponds to the front finish colour</p>	300	600	988	H B A 6 5 6 B C 1	
Wall units					
 <p>Wall unit 1 door with buffered closing 1 glass shelf 1 top cover 180 mm deep</p> <p>Colour version of top cover corresponds to the front finish colour</p>	150	300	668	O G A 4 1 3 B C 1	L/R
	150	400	668	O G A 4 1 4 B C 1	L/R
 <p>Wall unit 2 doors with buffered closing 1 glass shelf 1 top cover 180 mm deep</p> <p>Colour version of top cover corresponds to the front finish colour</p>	150	600	668	O G A 4 1 6 B C 1	
Shelves					
 <p>functional shelf Edges are cut with a mitre vertical and horizontal mounting possible</p> <p>please indicate colour version: no. 501 white matt lacquered no. 547 black matt lacquered</p>	150	300	160	R G L 1 1 3 0 0 1	
 <p>functional shelf Edges are cut with a mitre vertical and horizontal mounting possible</p> <p>please indicate colour version: no. 501 white matt lacquered no. 547 black matt lacquered</p>	150	600	160	R G L 1 1 6 0 0 2	



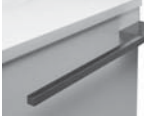





b - maxx - model list

Depth indication corresponds to the carcass depth		Depth in mm	Width in mm	Height in mm	Article number		Hinge					
Shelves												
	functional shelf Edges are cut with a mitre vertical and horizontal mounting possible please indicate colour version: no. 501 white matt lacquered no. 547 black matt lacquered	150	900	160	RGL	1 1 9 0 0 3						
Glass shelves												
	Glass shelf incl. metal holder 400 mm wide incl. 2 metal brackets 600 mm wide incl. 2 metal brackets 700 mm wide incl. 2 metal brackets 1000 mm wide incl. 3 metal brackets	130	400	8	ABG	1 3 4 0 0 8						
		130	600	8	ABG	1 3 6 0 0 8						
		130	700	8	ABG	1 3 7 0 0 8						
		130	1000	8	ABG	1 3 1 0 0 8						
Accessories												
	Towel holder one-armed swiveling for mounting to wall or carcass Please observe carcass depth and furniture height Chrome hgl. black	420	30	46	PZ	1 1 4 7 1						
		420	30	46	PZ	1 1 4 7 2						
	Towel holder one-armed front opened for assembling at the washbasin base unit Please observe carcass depth and furniture height Chrome hgl. black	390	55	30	PZ	1 1 2 8 1 1						
		390	55	30	PZ	1 1 2 8 1 2						





b - maxx - model list

Depth indication corresponds to the carcass depth		Depth in mm	Width in mm	Height in mm	Article number			Hinge				
Accessories												
	<p>Towel holder two-armed front opened for assembling at the washbasin base unit Please observe carcass depth and furniture height</p> <p>Chrome hgl.</p> <p>black</p>	390	110	30	P Z	1 1 2 8	1					
		390	110	30	P Z	1 1 2 8	2					
	<p>Towel holder one-armed extendable chrome gloss wall-mounted</p>	330-567	44	44	P Z	1 1 3 7	1					
	<p>Towel holder two-armed extendable chrome gloss wall-mounted</p>	322-562	87	47	P Z	1 1 3 7	2					
	<p>Towel holder chrome gloss to fit on carcass at side front opened</p> <p>Please observe carcass depth and furniture height</p>	390	60		P Z	1 1 2 4	1					
	<p>Emotion lighting sensor switcher for dimming and for colour change control</p> <p>for all identified cabinets</p>				P Z	1 0 2 0	1					
												
	<p>Remote switch incl. receiver for LED lighting for dimming and for colour change control Reach up to 5 meters</p> <p>not suitable for LED converter over 30 watt</p>		85	85	P Z	1 1 4 3						
	<p>Motion sensor for LED lighting of washbasins or washbasin base units Term and sensitivity of lighting are adjustable</p>				P Z	1 1 4 1						



b - maxx - model list

Depth indication corresponds to the carcass depth		Depth in mm	Width in mm	Height in mm	Article number		Hinge					
Accessories												
	<p>USB socket element 2 plus-in slots connection 220 V with clamp</p> <p>installed in mirror cabinet please state position</p> <p>not installed in mirror cabinet</p>	45 45	80 80	64 64	P Z	1 1 5 1 E B 1 1 5 1 1						
 	<p>LED washbasin lighting emotion 2,6 Watt / 187 lumens / (2700 -) 6500 Kelvin 1 switch element IED converter This product contains a light source with energy efficiency class: G</p> <p>LED mood lighting available as an option</p>	16	560	7	P Z	1 1 5 0 6 0						
 	<p>LED washbasin lighting emotion 4,0 Watt / 287 lumens / (2700 -) 6500 Kelvin 1 switch element IED converter This product contains a light source with energy efficiency class: G</p> <p>LED mood lighting available as an option</p>	16	860	7	P Z	1 1 5 0 9 0						
	<p>LED washbasin lighting 2,4 Watt / 168 lumens / 6500 Kelvin 1 switch element to fit underneath mirror cabinet This product contains a light source with energy efficiency class: G</p> <p>not suitable with Emotion lighting</p>	10	560	10	P Z	1 0 6 3 6 0						
	<p>LED washbasin lighting 3,9 Watt / 287 lumens / 6500 Kelvin 1 switch element to fit underneath mirror cabinet This product contains a light source with energy efficiency class: G</p> <p>not suitable with Emotion lighting</p>	10	860	10	P Z	1 0 6 3 9 0						
	<p>Adjustable organizer components</p> <p>4 dividing elements - 750 mm cabinet width</p> <p>5 dividing elements - 1000 mm cabinet width</p> <p>not possible for variant 560</p>				P Z	1 2 2 4 7 5 1 2 2 4 1 0						

b - maxx - model list

Depth indication corresponds to the carcass depth	Depth in mm	Width in mm	Height in mm	Article number	Hinge
Accessories					
 <p>Basin organizer incl. fixing elements</p> <p>2 basin organizer for 750 mm carbinet width 2 basin organizer for 1000 mm carbinet width not possible for variant 560</p>				P Z 1 2 3 6 7 5 P Z 1 2 3 6 1 0	
 <p>Basin organizer without fitting elements</p>	150	246	150	P Z 1 2 3 6 E 1	
 <p>Drawer set for metal drawers Consisting of: - 1 aluminium-coloured plastic insert - 2 aluminium coloured dividers, adjustable for 30 cm wide cabinets for 40 cm width units</p>				P Z 1 2 2 5 3 0 P Z 1 2 2 5 4 0	
 <p>Space-saving drain stench trap from GEBERIT made of plastic, in white nominal diameter: 40</p>				P Z 1 3 6 7	
 <p>Space-saving drain stench trap from GEBERIT made of plastic, in white nominal diameter: 32</p>				P Z 1 4 2 3	

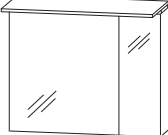
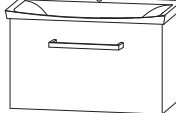
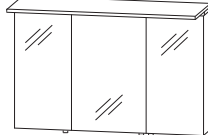
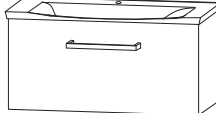
b - maxx - bathroom variations

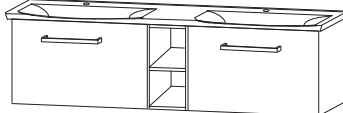
BME-0175-1				
1	Mirror cabinet LED	S B C 4 L 7 5 0 1		  <p style="text-align: right;">750 mm wide</p>
1	Washbasin base unit	W U A 3 2 7 5 0 3		
1	evermite washbasin, 750 mm with LED lighting	S W M 7 5 1 2 B 2		
BME-0110-1				
1	Mirror cabinet LED	S B C 4 1 1 0 0 1		  <p style="text-align: right;">1000 mm wide</p>
1	Washbasin base unit	W U A 3 2 1 0 0 3		
1	evermite washbasin, 1000 mm with LED lighting	S W M 1 0 1 2 B 2		
BME-0117-1				
1	Mirror cabinet LED	S B C 4 1 1 7 0 1		  <p style="text-align: right;">1700 mm wide</p>
1	Washbasin base unit	W U A 3 2 1 7 0 3		
1	evermite washbasin, 1700 mm with LED lighting	S W M 1 7 1 2 B 2		

b . maxx - dimensional drawings

WMS / SWM 7512

WMS / SWM 1012

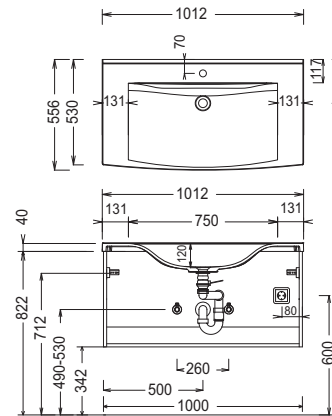
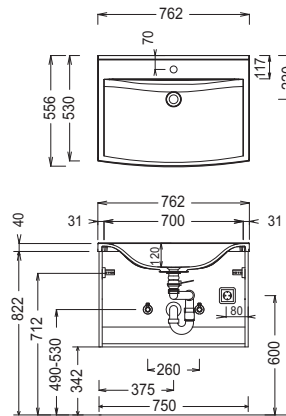

WMS / SWM 1712

electrical connections for mirror cabinets

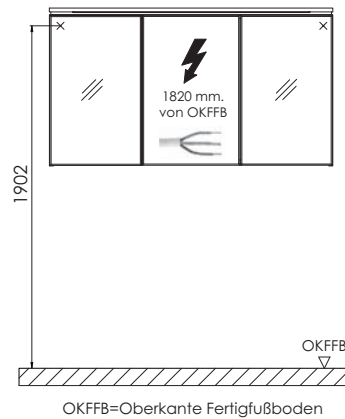
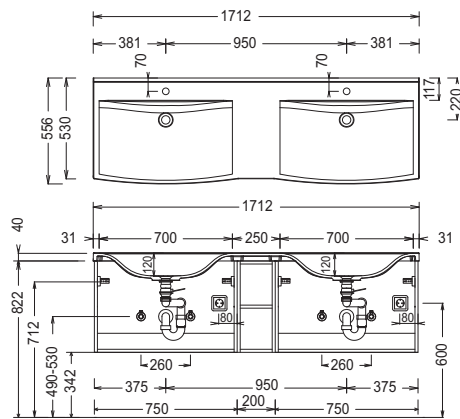

Evermite:

The water temperature must not exceed 55° C / 131° F. Hair tinting lotions have to be removed in a few seconds, so that staining can be avoided.

Modifications:

Technical modifications (+/- 5mm) and flatness modifications (DIN 18202) are subject of the usual material-specific modifications for construction materials, based on DIN 18202.