



## Front colours



No. 778 cosmos grey lacquer matt



No. 780 white lacquer hgl.



Nr. 783 natural oak

**L** lacquered front

**F** foiled front

## carcass colours

\* High gloss carcass for an additional price



No. 177 cosmos grey matt

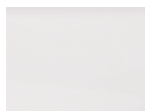

\*no. 161 white hgl.



Nr. 185 natural oak

## Technique

door with integrated buffered closing

No. 554  
Pull outs and drawers with soft close  
optional:  
No. 555  
pull-out units and drawer with chrome edge

No. 560  
Pull-outs with glass rail and drawer with chrome edge  
Washbasin base units with b-collection label

## Washbasin colours

Cast mineral washbasins



no. 1 white

Cast mineral tops with top-mounted washbasins



no. 1 white

## Handle version

handleless with recessed grip









Illustrations and specifications are without obligation. Technical modifications reserved.

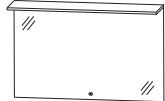







2022/2023 - ID

Please note the instruction for warranty, mounting and care, and the quality agreements as well, at the beginning of the book.







## b - straight - model list

| Depth indication corresponds to the carcass depth   | Depth in mm  | Width in mm | Height in mm | Article number | Hinge                    |
|---|--|-------------|--------------|----------------|--------------------------|
| <b>Mirrors</b>  |  |             |              |                |                          |
|       | <p><b>Mirror</b><br/>1 LED panel light<br/>Emotion lighting<br/>1 LED converter<br/>incl. LED washbasin lighting<br/>This product contains a light source with energy efficiency class: F</p>  |             |              |                |                          |
|   | <p><b>600 mm wide</b><br/>17,1 watt / 1607 lumens / 2700 - 6500 Kelvin</p>   | 91          | 600          | 652            | <b>F S B 4 1 6 0 0 1</b> |
|   | <p><b>900 mm wide</b><br/>26,4 watt / 2482 lumens / 2700 - 6500 Kelvin</p>   | 91          | 900          | 652            | <b>F S B 4 1 9 0 0 1</b> |
|   | <p><b>1200 mm wide</b><br/>35,7 watt / 3356 lumens / 2700 - 6500 Kelvin</p>  | 91          | 1200         | 652            | <b>F S B 4 1 1 2 0 1</b> |
|   | <p><b>1400 mm wide</b><br/>41,9 watt / 3939 lumens / 2700 - 6500 Kelvin</p>  | 91          | 1400         | 652            | <b>F S B 4 1 1 4 0 1</b> |
|   | <p><b>Mirror</b><br/>LED acrylic strips at top and bottom<br/>Emotion lighting<br/>1 LED converter<br/>This product contains a light source with energy efficiency class: F</p>  |             |              |                |                          |
|   | <p><b>600 mm wide</b><br/>17,1 watt / 1607 lumens / 2700 - 6500 Kelvin</p>   | 28          | 600          | 640            | <b>F S B 4 3 6 0 0 1</b> |
|   | <p><b>900 mm wide</b><br/>26,4 watt / 2482 lumens / 2700 - 6500 Kelvin</p>   | 28          | 900          | 640            | <b>F S B 4 3 9 0 0 1</b> |
|   | <p><b>1200 mm wide</b><br/>35,7 watt / 3356 lumens / 2700 - 6500 Kelvin</p>  | 28          | 1200         | 640            | <b>F S B 4 3 1 2 0 1</b> |
|   | <p><b>1400 mm wide</b><br/>41,9 watt / 3939 lumens / 2700 - 6500 Kelvin</p>  | 28          | 1400         | 640            | <b>F S B 4 3 1 4 0 1</b> |
|   | <p><b>Mirror</b><br/>LED aluminium frame<br/>all-round LED lighting<br/>37,2 watt / converter 60 watt<br/>3497 lumens / 2700 - 6500 Kelvin<br/>Emotion lighting<br/>This product contains a light source with energy efficiency class: F</p> |             |              |                |                          |
|   | <p><b>aluminium frame in black matt anodize</b></p>  | 40          | 600          | 640            | <b>F S B 4 5 6 0 0 4</b> |
|   | <p><b>aluminium fram in white matt lacquered</b></p>   | 40          | 600          | 640            | <b>F S B 4 5 6 0 0 5</b> |

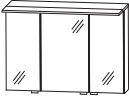

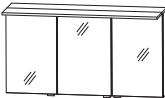
## b - straight - model list

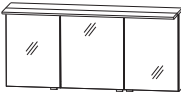
| Depth indication corresponds to the carcass depth   |   | Depth<br>in mm | Width<br>in mm | Height<br>in mm | Article number                                      | Hinge |  |  |  |
|---|---|----------------|----------------|-----------------|---|-------|--|--|--|
| <b>Mirrors</b>  |   |                |                |                 |   |       |  |  |  |
| <br>  | <b>Mirror</b><br>LED aluminium frame<br>all-round LED lighting<br>46,5 watt / converter 60 watt<br>4371 lumens / 2700 - 6500 Kelvin<br>Emotion lighting<br>This product contains a light source with<br>energy efficiency class: F  |                |                |                 |   |       |  |  |  |
|   | <b>aluminium frame in black matt anodize</b>  | 40             | 900            | 640             | <b>F S B 4 5 9 0 0 4</b>                            |       |  |  |  |
|   | <b>aluminium fram in white matt lacquered</b>   | 40             | 900            | 640             | <b>F S B 4 5 9 0 0 5</b>                            |       |  |  |  |
| <br>  | <b>Mirror</b><br>LED aluminium frame<br>all-round LED lighting<br>55,8 watt / converter 60 watt<br>5245 lumens / 2700 - 6500 Kelvin<br>Emotion lighting<br>This product contains a light source with<br>energy efficiency class: F  |                |                |                 |   |       |  |  |  |
|   | <b>aluminium frame in black matt anodize</b>  | 40             | 1200           | 640             | <b>F S B 4 5 1 2 0 4</b>                            |       |  |  |  |
|   | <b>aluminium fram in white matt lacquered</b>   | 40             | 1200           | 640             | <b>F S B 4 5 1 2 0 5</b>                            |       |  |  |  |
| <br>  | <b>Mirror</b><br>LED aluminium frame<br>all-round LED lighting<br>52,0 watt / converter 60 watt<br>5980 lumens / 2700 - 6500 Kelvin<br>Emotion lighting<br>This product contains a light source with<br>energy efficiency class: G  |                |                |                 |   |       |  |  |  |
|   | <b>aluminium frame in black matt anodize</b>  | 40             | 1400           | 640             | <b>F S B 4 5 1 4 0 4</b>                            |       |  |  |  |
|   | <b>aluminium fram in white matt lacquered</b>   | 40             | 1400           | 640             | <b>F S B 4 5 1 4 0 5</b>                            |       |  |  |  |
| <b>Mirror cabinets</b>  |   |                |                |                 |   |       |  |  |  |
| <br><br>incl. handle blocks<br>III. = right | <b>mirror cabinet</b><br>2 double mirror doors<br>2 glass shelves<br>1 LED panel light<br>8,53 watt / converter 15 watt<br>699 lumens / (2700 -) 6500 Kelvin<br>1 switch socket element<br>Door width: 196 mm / 396 mm<br>This product contains a light source with<br>energy efficiency class: F | 150            | 600            | 660             | <b>S 2 A 4 3 6 0 8 8</b>                            | L/R   |  |  |  |
|   | Additional accessories<br>LED washbasin lighting<br>LED washbasin lighting emotion<br>Emotion lighting  |                |                |                 | P Z 1 0 6 3 6 0<br>P Z 1 1 5 0 6 0<br>P Z 1 0 2 0 1 |       |  |  |  |

## b - straight - model list



| Depth indication corresponds to the carcass depth  |  | Depth<br>in mm | Width<br>in mm | Height<br>in mm | Article number                                      | Hinge |  |  |  |  |
|--|--|----------------|----------------|-----------------|---|-------|--|--|--|--|
| <br><br>incl. handle blocks  |  | 150            | 900            | 660             | <b>S 2 A 4 3 9 0 8 8</b>                            |       |  |  |  |  |
| <b>mirror cabinet</b><br>3 double mirror doors<br>2 central partitions,<br>6 glass shelves<br>1 LED panel light<br>13,2 watt / converter 30watt<br>1082 lumens / (2700 -) 6500 Kelvin<br>1 switch socket element<br>Door width: 238 mm / 412 mm / 238 mm<br>This product contains a light source with<br>energy efficiency class: F<br><br>Additional accessories<br>LED washbasin lighting<br>LED washbasin lighting emotion<br>Emotion lighting  |  |                |                |                 | P Z 1 0 6 3 9 0<br>P Z 1 1 5 0 9 0<br>P Z 1 0 2 0 1 |       |  |  |  |  |
| <br><br>incl. handle blocks   |  | 150            | 1200           | 660             | <b>S 2 A 4 3 1 2 8 8</b>                            |       |  |  |  |  |
| <b>mirror cabinet</b><br>3 double mirror doors<br>2 central partitions,<br>6 glass shelves<br>1 LED panel light<br>17,8 watt / converter 30 watt<br>1462 lumens / (2700 -) 6500 Kelvin<br>1 switch socket element<br>Door width: 388 mm / 412 mm / 388 mm<br>This product contains a light source with<br>energy efficiency class: F<br><br>Additional accessories<br>LED washbasin lighting<br>LED washbasin lighting emotion<br>Emotion lighting |  |                |                |                 | P Z 1 0 6 3 1 2<br>P Z 1 1 5 0 1 2<br>P Z 1 0 2 0 1 |       |  |  |  |  |
| <br><br>incl. handle blocks  |  | 150            | 1400           | 660             | <b>S 2 A 4 3 1 4 8 8</b>                            |       |  |  |  |  |
| <b>mirror cabinet</b><br>3 double mirror doors<br>2 central partitions,<br>6 glass shelves<br>1 LED panel light<br>20,9 watt / converter 30 watt<br>1716 lumens / (2700 -) 6500 Kelvin<br>1 switch socket element<br>Door width: 446 mm / 496 mm / 446 mm<br>This product contains a light source with<br>energy efficiency class: F<br><br>Additional accessories<br>LED washbasin lighting<br>LED washbasin lighting emotion<br>Emotion lighting |  |                |                |                 | P Z 1 0 6 3 1 2<br>P Z 1 1 5 0 1 2<br>P Z 1 0 2 0 1 |       |  |  |  |  |

## b - straight - model list

| Depth indication corresponds to the carcass depth                                   | Depth<br>in mm | Width<br>in mm | Height<br>in mm | Article number         |  |  | Hinge |  |  |  |  |
|---|----------------|----------------|-----------------|------------------------|--|--|-------|--|--|--|--|
| <b>Cast mineral washbasins</b>  |                |                |                 |                        |  |  |       |  |  |  |  |
|    | 500            | 606            | 25              | <b>SWM 9 3 0 6 1</b>   |  |  |       |  |  |  |  |
|   | 500            | 606            | 25              | <b>SWM 9 3 0 6 B 1</b> |  |  |       |  |  |  |  |
|   | 500            | 906            | 25              | <b>SWM 9 3 0 9 1</b>   |  |  |       |  |  |  |  |
|   | 500            | 906            | 25              | <b>SWM 9 3 0 9 B 1</b> |  |  |       |  |  |  |  |
|  | 500            | 1206           | 25              | <b>SWM 9 3 1 2 1</b>   |  |  |       |  |  |  |  |
|   | 500            | 1206           | 25              | <b>SWM 9 3 1 2 B 1</b> |  |  |       |  |  |  |  |



You find information on the the washbasin manufacturer at the beginning of the sales book.

## b - straight - model list







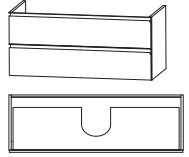
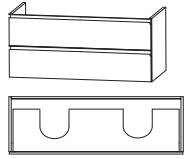

|   | Depth<br>in mm | Width<br>in mm | Height<br>in mm | Article number       |          | Hinge |  |  |  |  |
|---|----------------|----------------|-----------------|----------------------|----------|-------|--|--|--|--|
| Depth indication corresponds to the carcass depth   |                |                |                 |                      |          |       |  |  |  |  |
| <b>Cast mineral washbasins</b>  |                |                |                 |                      |          |       |  |  |  |  |
|   | 500            | 1206           | 25              | <b>SWM 9 3 2 D</b>   | <b>1</b> |       |  |  |  |  |
| <p>colour white<br/>incl. CLOU drain and overflow system in chrome</p>  |                |                |                 |                      |          |       |  |  |  |  |
|   | 500            | 1206           | 25              | <b>SWM 9 3 2 D B</b> | <b>1</b> |       |  |  |  |  |
| <p><b>Cast mineral double washbasin bordered LED lighting</b><br/>5,5 Watt / converter 15 Watt<br/>497 lumens / 6500 Kelvin<br/>colour white<br/>incl. CLOU drain and overflow system in chrome<br/>This product contains a light source with energy efficiency class: F</p> <p>can combined with WUA 3312 12, WUA 1112 12</p> <p>Additional accessories<br/>motion sensor for LED lighting</p> |                |                |                 | P Z                  | 1 1 4 1  |       |  |  |  |  |
|   | 500            | 1406           | 25              | <b>SWM 9 3 1 4</b>   | <b>1</b> |       |  |  |  |  |
| <p>colour white<br/>incl. CLOU drain and overflow system in chrome</p>  |                |                |                 |                      |          |       |  |  |  |  |
|   | 500            | 1406           | 25              | <b>SWM 9 3 1 4 B</b> | <b>1</b> |       |  |  |  |  |
| <p><b>Cast mineral washbasin bordered LED lighting</b><br/>6,5 Watt / converter 15 Watt<br/>583 lumens / 6500 Kelvin<br/>colour white<br/>incl. CLOU drain and overflow system in chrome<br/>This product contains a light source with energy efficiency class: F</p> <p>can combined with WUA 3314 10, WUA 1114 10</p> <p>Additional accessories<br/>motion sensor for LED lighting</p>        |                |                |                 | P Z                  | 1 1 4 1  |       |  |  |  |  |
|   | 500            | 1406           | 25              | <b>SWM 9 3 4 D</b>   | <b>1</b> |       |  |  |  |  |
| <p>colour white<br/>incl. CLOU drain and overflow system in chrome</p>  |                |                |                 |                      |          |       |  |  |  |  |
|   | 500            | 1406           | 25              | <b>SWM 9 3 4 D B</b> | <b>1</b> |       |  |  |  |  |
| <p><b>Cast mineral double washbasin bordered LED lighting</b><br/>6,5 Watt / converter 15 Watt<br/>583 lumens / 6500 Kelvin<br/>colour white<br/>incl. CLOU drain and overflow system in chrome<br/>This product contains a light source with energy efficiency class: F</p> <p>can combined with WUA 3314 12, WUA 1114 12</p> <p>Additional accessories<br/>motion sensor for LED lighting</p> |                |                |                 | P Z                  | 1 1 4 1  |       |  |  |  |  |

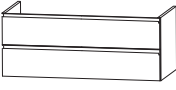
You find information on the the washbasin manufacturer at the beginning of the sales book.

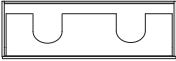
## b - straight - model list

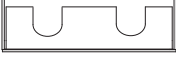

| Depth indication corresponds to the carcass depth   | Depth in mm | Width in mm | Height in mm | Article number   |  |  |  |  |
|---|-------------|-------------|--------------|--|--|--|--|--|
|  <p><b>Washbasin base unit</b><br/>1 metal pull out unit with buffered closing<br/>1 aluminium-coloured organizer components<br/>1 metal pull out unit with buffered closing and rail</p> <p>for cast mineral washbasins</p> <p>Additional accessories<br/>Space-saving drain stench trap DN 40<br/>Space-saving drain stench trap DN 32</p>   | 470         | 600         | 480          | <b>W U A 3 3 6 0 1 0</b><br><br>P Z 1 3 6 7<br>P Z 1 4 2 3 |  |  |  |  |
|  <p><b>Washbasin base unit</b><br/>1 metal pull out unit with buffered closing<br/>1 aluminium-coloured organizer components<br/>1 metal pull out unit with buffered closing and rail</p> <p>for cast mineral washbasins</p> <p>Additional accessories<br/>Space-saving drain stench trap DN 40<br/>Space-saving drain stench trap DN 32</p>   | 470         | 900         | 480          | <b>W U A 3 3 9 0 1 0</b><br><br>P Z 1 3 6 7<br>P Z 1 4 2 3 |  |  |  |  |
|  <p><b>Washbasin base unit</b><br/>1 metal pull out unit with buffered closing<br/>1 aluminium-coloured organizer components<br/>1 metal pull out unit with buffered closing and rail</p> <p>for single washbasin solution<br/>for cast mineral washbasins</p> <p>Additional accessories<br/>Space-saving drain stench trap DN 40<br/>Space-saving drain stench trap DN 32</p>   | 470         | 1200        | 480          | <b>W U A 3 3 1 2 1 0</b><br><br>P Z 1 3 6 7<br>P Z 1 4 2 3 |  |  |  |  |
|  <p><b>Washbasin base unit for double washbasin solutions</b><br/>1 metal pull out unit with buffered closing<br/>2 aluminium-coloured organizer components<br/>1 metal pull out unit with buffered closing and rail</p> <p>for double washbasin solutions<br/>for cast mineral washbasins</p> <p>Additional accessories<br/>Space-saving drain stench trap DN 40 (order 2 pieces)<br/>Space-saving drain stench trap DN 32 (order 2 pieces)</p> | 470         | 1200        | 480          | <b>W U A 3 3 1 2 1 2</b><br><br>P Z 1 3 6 7<br>P Z 1 4 2 3 |  |  |  |  |

## b - straight - model list

| Depth indication corresponds to the carcass depth                                  |   | Depth<br>in mm | Width<br>in mm | Height<br>in mm | Article number             | Hinge |  |  |  |  |  |
|--|---|----------------|----------------|-----------------|----------------------------|-------|--|--|--|--|--|
| <b>Washbasin base units</b>  |   |                |                |                 |                            |       |  |  |  |  |  |
|    | <b>Washbasin base unit</b><br>1 metal pull out unit with buffered closing<br>1 aluminium-coloured organizer components                                | 470            | 1400           | 480             | <b>W U A 3 3 1 4 1 0</b>   |       |  |  |  |  |  |
|    | 1 metal pull out unit with buffered closing and rail<br><br>for single washbasin solution<br>for cast mineral washbasins                              |                |                |                 |                            |       |  |  |  |  |  |
|  | Additional accessories<br>Space-saving drain stench trap DN 40<br>Space-saving drain stench trap DN 32  |                |                |                 | P Z 1 3 6 7<br>P Z 1 4 2 3 |       |  |  |  |  |  |
|    | <b>Washbasin base unit for double washbasin solutions</b><br>1 metal pull out unit with buffered closing<br>2 aluminium-coloured organizer components | 470            | 1400           | 480             | <b>W U A 3 3 1 4 1 2</b>   |       |  |  |  |  |  |
|    | 1 metal pull out unit with buffered closing and rail<br><br>for double washbasin solutions<br>for cast mineral washbasins                             |                |                |                 |                            |       |  |  |  |  |  |
|  | Additional accessories<br>Space-saving drain stench trap DN 40 (order 2 pieces)<br>Space-saving drain stench trap DN 32 (order 2 pieces)              |                |                |                 | P Z 1 3 6 7<br>P Z 1 4 2 3 |       |  |  |  |  |  |
|  | <b>Washbasin base unit</b><br>1 metal pull out unit with buffered closing<br>1 aluminium-coloured organizer components                                | 470            | 600            | 240             | <b>W U A 1 1 6 0 1 0</b>   |       |  |  |  |  |  |
|  | for cast mineral washbasins   |                |                |                 |                            |       |  |  |  |  |  |
|  | <b>Washbasin base unit</b><br>1 metal pull out unit with buffered closing<br>1 aluminium-coloured organizer components                                | 470            | 900            | 240             | <b>W U A 1 1 9 0 1 0</b>   |       |  |  |  |  |  |
|  | for cast mineral washbasins   |                |                |                 |                            |       |  |  |  |  |  |
|  | <b>Washbasin base unit</b><br>1 metal pull out unit with buffered closing<br>1 aluminium-coloured organizer components                                | 470            | 1200           | 240             | <b>W U A 1 1 1 2 1 0</b>   |       |  |  |  |  |  |
|  | for single washbasin solution<br>for cast mineral washbasins  |                |                |                 |                            |       |  |  |  |  |  |
|  | <b>Washbasin base unit</b><br>1 metal pull out unit with buffered closing<br>2 aluminium-coloured organizer components                                | 470            | 1200           | 240             | <b>W U A 1 1 1 2 1 2</b>   |       |  |  |  |  |  |
|  | for double washbasin solutions<br>for cast mineral washbasins   |                |                |                 |                            |       |  |  |  |  |  |



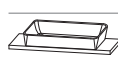

## b - straight - model list

| Depth indication corresponds to the carcass depth  | Depth in mm | Width in mm | Height in mm | Article number           | Hinge |
|--|-------------|-------------|--------------|--------------------------|-------|
| <b>Washbasin base units</b>  |             |             |              |                          |       |
|  <p><b>Washbasin base unit</b><br/>1 metal pull out unit with buffered closing<br/>1 aluminium-coloured organizer components</p> <p>for single washbasin solution</p> <p>for cast mineral washbasins</p>  | 470         | 1400        | 240          | <b>W U A 1 1 1 4 1 0</b> |       |
|  <p><b>Washbasin base unit</b><br/>1 metal pull out unit with buffered closing<br/>2 aluminium-coloured organizer components</p> <p>for double washbasin solutions</p> <p>for cast mineral washbasins</p>   | 470         | 1400        | 240          | <b>W U A 1 1 1 4 1 2</b> |       |
| <b>Cast mineral tops with top-mounted washbasins</b>   |             |             |              |                          |       |
|  <p><b>Cast mineral top with top-mounted washbasin</b><br/>1 top-mounted washbasin, 490 mm colour white<br/>incl. permanent drain</p> <p><b>Cast mineral top with top-mounted washbasin, LED</b><br/>Description as above, though LED- lighting<br/>2,7 watt / converter 15 watt<br/>238 lumens / 6500 Kelvin<br/>This product contains a light source with energy efficiency class: F</p> <p>can be combined with WUA 3360 16,<br/>WUA 1160 16</p> <p>Design siphon must also be ordered in combination with<br/>WUA 1160/90/12/14 16/17<br/>see accessories - PZ 1389 1E/ PZ 1374 1</p> | 500         | 612         | 85           | <b>M W P 1 0 6 M 1</b>   |       |
|  | 500         | 612         | 85           | <b>M W P 1 0 6 M B 1</b> |       |



You find information on the the washbasin manufacturer at the beginning of the sales book.

## b - straight - model list

| Depth indication corresponds to the carcass depth  | Depth<br>in mm | Width<br>in mm | Height<br>in mm | Article number         | Hinge |  |  |  |  |
|--|----------------|----------------|-----------------|------------------------|-------|--|--|--|--|
| <h3>Cast mineral tops with top-mounted washbasins</h3>   |                |                |                 |                        |       |  |  |  |  |
|  <p><b>Cast mineral top with top-mounted washbasin</b></p> <p>1 top-mounted washbasin, 600 mm colour white<br/>incl. permanent drain</p> <p><b>Cast mineral top with top-mounted washbasin, LED</b></p> <p>Description as above, though LED- lighting<br/>4,1 watt / converter 15 watt<br/>367 lumens / 6500 Kelvin<br/>This product contains a light source with energy efficiency class: F</p> <p>can combined with WUA 3390 16, WUA 1190 16</p> <p>Design siphon must also be ordered in combination with<br/>WUA 1160/90/12/14 16/17<br/>see accessories - PZ 1389 1E/ PZ 1374 1</p>   | 500            | 912            | 85              | <b>MWP 1 0 9 M 1</b>   |       |  |  |  |  |
|  | 500            | 912            | 85              | <b>MWP 1 0 9 M B 1</b> |       |  |  |  |  |
|  <p><b>Cast mineral top with top-mounted washbasin</b></p> <p>1 top-mounted washbasin, 600 mm colour white<br/>incl. permanent drain</p> <p><b>Cast mineral top with top-mounted washbasin, LED</b></p> <p>Description as above, though LED- lighting<br/>5,5 Watt / converter 15 Watt<br/>497 lumens / 6500 Kelvin<br/>This product contains a light source with energy efficiency class: F</p> <p>can combined with WUA 3312 16, WUA 1112 16</p> <p>Design siphon must also be ordered in combination with<br/>WUA 1160/90/12/14 16/17<br/>see accessories - PZ 1389 1E/ PZ 1374 1</p> | 500            | 1212           | 85              | <b>MWP 1 1 2 M 1</b>   |       |  |  |  |  |
|  | 500            | 1212           | 85              | <b>MWP 1 1 2 M B 1</b> |       |  |  |  |  |



You find information on the the washbasin manufacturer at the beginning of the sales book.

## b - straight - model list

| Depth indication corresponds to the carcass depth                                   | Depth in mm   | Width in mm | Height in mm | Article number         | Hinge |
|---|---|-------------|--------------|------------------------|-------|
| <h3>Cast mineral tops with top-mounted washbasins</h3>                              |   |             |              |                        |       |
|    | <b>Cast mineral top with top-mounted washbasin</b>  |             |              |                        |       |
|   | 500   | 1212        | 85           | <b>MWP 1 1 2 D 1</b>   |       |
|   | 500   | 1212        | 85           | <b>MWP 1 1 2 D B 1</b> |       |
|   | <b>Cast mineral top with top-mounted washbasin, LED</b><br>Description as above, though LED- lighting<br>5,5 Watt / converter 15 Watt<br>497 lumens / 6500 Kelvin<br>This product contains a light source with energy efficiency class: F<br><br>can combined with WUA 3312 17, WUA 1112 17<br><br>Design siphon must also be ordered in combination with<br>WUA 1160/90/12/14 16/17<br>see accessories - PZ 1389 1E/ PZ 1374 1 |             |              |                        |       |
|  | <b>Cast mineral top with top-mounted washbasin</b>  |             |              |                        |       |
|   | 500   | 1412        | 85           | <b>MWP 1 1 4 M 1</b>   |       |
|   | 500   | 1412        | 85           | <b>MWP 1 1 4 M B 1</b> |       |
|   | <b>Cast mineral top with top-mounted washbasin, LED</b><br>Description as above, though LED- lighting<br>6,5 Watt / converter 15 Watt<br>583 lumens / 6500 Kelvin<br>This product contains a light source with energy efficiency class: F<br><br>can combined with WUA 3314 16, WUA 1114 16<br><br>Design siphon must also be ordered in combination with<br>WUA 1160/90/12/14 16/17<br>see accessories - PZ 1389 1E/ PZ 1374 1 |             |              |                        |       |

You find information on the the washbasin manufacturer at the beginning of the sales book.

## b - straight - model list



| Depth indication corresponds to the carcass depth  | Depth in mm | Width in mm | Height in mm | Article number         | Hinge |  |  |  |  |
|--|-------------|-------------|--------------|------------------------|-------|--|--|--|--|
| <h3>Cast mineral tops with top-mounted washbasins</h3>   |             |             |              |                        |       |  |  |  |  |
|  <p><b>Cast mineral top with top-mounted washbasin</b><br/>2 fitted washbasins, 490 mm each<br/>colour white<br/>incl. permanent drain</p> <p><b>Cast mineral top with top-mounted washbasin, LED</b><br/>Description as above, though LED- lighting<br/>6,5 Watt / converter 15 Watt<br/>583 lumens / 6500 Kelvin<br/>This product contains a light source with energy efficiency class: F<br/>can combined with WUA 3314 17, WUA 1114 17</p> <p>Design siphon must also be ordered in combination with<br/>WUA 1160/90/12/14 16/17<br/>see accessories - PZ 1389 1E/ PZ 1374 1</p> | 500         | 1412        | 85           | <b>MWP 1 1 4 D 1</b>   |       |  |  |  |  |
|  | 500         | 1412        | 85           | <b>MWP 1 1 4 D B 1</b> |       |  |  |  |  |
| <h3>Washbasin base units</h3>  |             |             |              |                        |       |  |  |  |  |
|  <p><b>Washbasin base unit</b><br/>1 metal pull out unit with buffered closing<br/>1 aluminium-coloured organizer components<br/>1 metal pull out unit with buffered closing and rail</p> <p>for cast mineral tops with top-mounted washbasins</p> <p>Additional accessories<br/>Space-saving drain stench trap DN 40<br/>Space-saving drain stench trap DN 32</p>   | 470         | 600         | 480          | <b>WUA 3 3 6 0 1 6</b> |       |  |  |  |  |
|  <p><b>Washbasin base unit</b><br/>1 metal pull out unit with buffered closing<br/>1 aluminium-coloured organizer components<br/>1 metal pull out unit with buffered closing and rail</p> <p>for cast mineral tops with top-mounted washbasins</p> <p>Additional accessories<br/>Space-saving drain stench trap DN 40<br/>Space-saving drain stench trap DN 32</p>   | 470         | 900         | 480          | <b>WUA 3 3 9 0 1 6</b> |       |  |  |  |  |

You find information on the the washbasin manufacturer at the beginning of the sales book.

## b - straight - model list

| Depth indication corresponds to the carcass depth   | Depth in mm | Width in mm | Height in mm | Article number   | Hinge |
|---|-------------|-------------|--------------|--|-------|
| <p><b>Washbasin base unit</b><br/>           1 metal pull out unit with buffered closing<br/>           1 aluminium-coloured organizer components<br/>           1 metal pull out unit with buffered closing and rail</p> <p>for single washbasin solution<br/>           for cast mineral tops with top-mounted washbasins</p> <p>Additional accessories<br/>           Space-saving drain stench trap DN 40<br/>           Space-saving drain stench trap DN 32</p>   | 470         | 1200        | 480          | <b>W U A 3 3 1 2 1 6</b><br><br><br><br><br><br>P Z 1 3 6 7<br>P Z 1 4 2 3 |       |
| <p><b>Washbasin base unit for double washbasin solutions</b><br/>           1 metal pull out unit with buffered closing<br/>           2 aluminium-coloured organizer components<br/>           1 metal pull out unit with buffered closing and rail</p> <p>for double washbasin solutions<br/>           for cast mineral tops with top-mounted washbasins</p> <p>Additional accessories<br/>           Space-saving drain stench trap DN 40 (order 2 pieces)<br/>           Space-saving drain stench trap DN 32 (order 2 pieces)</p> | 470         | 1200        | 480          | <b>W U A 3 3 1 2 1 7</b><br><br><br><br><br><br>P Z 1 3 6 7<br>P Z 1 4 2 3 |       |
| <p><b>Washbasin base unit</b><br/>           1 metal pull out unit with buffered closing<br/>           1 aluminium-coloured organizer components<br/>           1 metal pull out unit with buffered closing and rail</p> <p>for single washbasin solution<br/>           for cast mineral tops with top-mounted washbasins</p> <p>Additional accessories<br/>           Space-saving drain stench trap DN 40<br/>           Space-saving drain stench trap DN 32</p>   | 470         | 1400        | 480          | <b>W U A 3 3 1 4 1 6</b><br><br><br><br><br><br>P Z 1 3 6 7<br>P Z 1 4 2 3 |       |

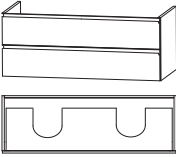
## b - straight - model list

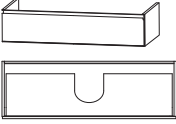
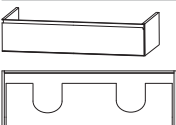
| Depth indication corresponds to the carcass depth                                  |  | Depth<br>in mm | Width<br>in mm | Height<br>in mm | Article number           |  |  | Hinge |  |  |  |  |
|--|--|----------------|----------------|-----------------|--------------------------|--|--|-------|--|--|--|--|
| <b>Washbasin base units</b>  |  |                |                |                 |                          |  |  |       |  |  |  |  |
|    | <p><b>Washbasin base unit for double washbasin solutions</b><br/>1 metal pull out unit with buffered closing<br/>2 aluminium-coloured organizer components</p> <p>1 metal pull out unit with buffered closing and rail<br/>for double washbasin solutions</p> <p>for cast mineral tops with top-mounted washbasins</p> <p>Additional accessories<br/>Space-saving drain stench trap DN 40 (order 2 pieces)<br/>Space-saving drain stench trap DN 32 (order 2 pieces)</p> | 470            | 1400           | 480             | <b>W U A 3 3 1 4 1 7</b> |  |  |       |  |  |  |  |
|    | <p><b>Washbasin base unit</b><br/>1 metal pull out unit with buffered closing<br/>1 aluminium-coloured organizer components</p> <p>for cast mineral tops with top-mounted washbasins</p>   | 470            | 600            | 240             | <b>W U A 1 1 6 0 1 6</b> |  |  |       |  |  |  |  |
|  | <p><b>Washbasin base unit</b><br/>1 metal pull out unit with buffered closing<br/>1 aluminium-coloured organizer components</p> <p>for cast mineral tops with top-mounted washbasins</p>   | 470            | 900            | 240             | <b>W U A 1 1 9 0 1 6</b> |  |  |       |  |  |  |  |
|  | <p><b>Washbasin base unit</b><br/>1 metal pull out unit with buffered closing<br/>1 aluminium-coloured organizer components</p> <p>for single washbasin solution</p> <p>for cast mineral tops with top-mounted washbasins</p>  | 470            | 1200           | 240             | <b>W U A 1 1 1 2 1 6</b> |  |  |       |  |  |  |  |
|  | <p><b>Washbasin base unit</b><br/>1 metal pull out unit with buffered closing<br/>2 aluminium-coloured organizer components</p> <p>for double washbasin solutions</p> <p>for cast mineral tops with top-mounted washbasins</p>   | 470            | 1200           | 240             | <b>W U A 1 1 1 2 1 7</b> |  |  |       |  |  |  |  |

## b - straight - model list

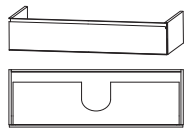
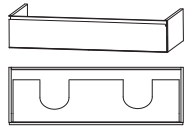
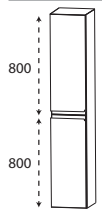
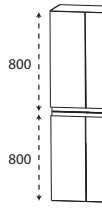
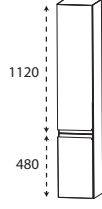

| Depth indication corresponds to the carcass depth  | Depth in mm | Width in mm | Height in mm | Article number           | Hinge |
|--|-------------|-------------|--------------|--------------------------|-------|
| <b>Washbasin base units</b>  |             |             |              |                          |       |
|  <p><b>Washbasin base unit</b><br/>1 metal pull out unit with buffered closing<br/>1 aluminium-coloured organizer components</p> <p>for single washbasin solution</p> <p>for cast mineral tops with top-mounted washbasins</p>  | 470         | 1400        | 240          | <b>W U A 1 1 1 4 1 6</b> |       |
|  <p><b>Washbasin base unit</b><br/>1 metal pull out unit with buffered closing<br/>2 aluminium-coloured organizer components</p> <p>for double washbasin solutions</p> <p>for cast mineral tops with top-mounted washbasins</p> | 470         | 1400        | 240          | <b>W U A 1 1 1 4 1 7</b> |       |
| <b>Tall units</b>  |             |             |              |                          |       |
|  <p><b>Tall unit</b><br/>2 doors with buffered closing<br/>2 glass shelves (top)<br/>2 adjustable shelves (bottom)</p>  | 300         | 300         | 1600         | <b>H N A 0 3 3 0</b>     | L/R   |
|  <p><b>Tall unit</b><br/>4 door with buffered closing<br/>2 glass shelves (top)<br/>2 adjustable shelves (bottom)</p>   | 300         | 600         | 1600         | <b>H N A 0 3 6 0</b>     |       |
|  <p><b>Tall unit</b><br/>2 doors with buffered closing<br/>4 glass shelves<br/>1 glass shelf</p>  | 300         | 300         | 1600         | <b>H N A 0 3 3 0</b>     | 4 L/R |

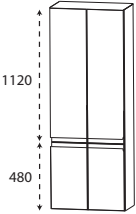
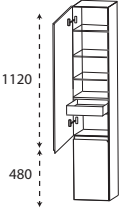
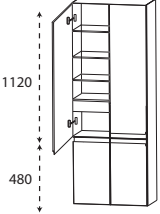
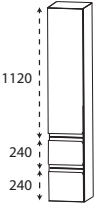
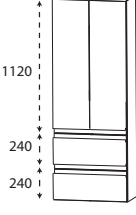
## b - straight - model list

| Depth indication corresponds to the carcass depth                                  |  | Depth<br>in mm | Width<br>in mm | Height<br>in mm | Article number | Hinge    |     |  |  |  |  |
|--|--|----------------|----------------|-----------------|----------------|----------|-----|--|--|--|--|
| <b>Tall units</b>  |  |                |                |                 |                |          |     |  |  |  |  |
|    | <p><b>Tall unit</b><br/>                     4 door with buffered closing<br/>                     4 glass shelves<br/>                     1 glass shelf</p>  | 300            | 600            | 1600            | <b>HNA0360</b> | <b>4</b> |     |  |  |  |  |
|   | <p><b>Tall unit</b><br/>                     1 door with buffered closing<br/>                     3 glass shelves (top)<br/>                     1 inside drawer with buffered closing<br/>                     1 door with buffered closing<br/>                     1 glass shelf</p>                     | 300            | 300            | 1600            | <b>HNA0430</b> | <b>4</b> | L/R |  |  |  |  |
|  | <p><b>Tall unit</b><br/>                     2 doors with buffered closing<br/>                     3 continuously glass shelves<br/>                     1 consistent inside drawer with buffered closing<br/>                     2 doors with buffered closing<br/>                     1 glass shelf</p> | 300            | 600            | 1600            | <b>HNA0460</b> | <b>4</b> |     |  |  |  |  |
|  | <p><b>Tall unit</b><br/>                     1 door with buffered closing<br/>                     4 glass shelves<br/>                     2 metal pull outs with buffered closing<br/>                     and rail</p>  | 300            | 300            | 1600            | <b>HNA0830</b> | <b>4</b> | L/R |  |  |  |  |
|  | <p><b>Tall unit</b><br/>                     2 doors with buffered closing<br/>                     4 glass shelves<br/>                     2 metal pull outs with buffered closing<br/>                     and rail</p>   | 300            | 600            | 1600            | <b>HNA0860</b> | <b>4</b> |     |  |  |  |  |

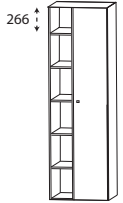

## b - straight - model list

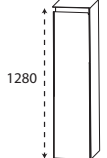
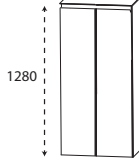
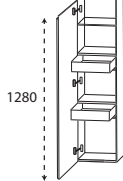
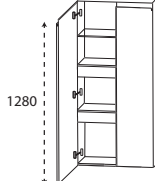
| Depth indication corresponds to the carcass depth  |  | Depth<br>in mm | Width<br>in mm | Height<br>in mm | Article number           | Hinge |  |  |  |  |
|--|--|----------------|----------------|-----------------|--------------------------|-------|--|--|--|--|
| <p><b>Tall units</b></p>  <p>266</p>  <p>Ill. = right</p>  |  | 300            | 500            | 1600            | <b>R H N 0 1 5 0 0 1</b> | L/R   |  |  |  |  |
| <p><b>Tall unit</b><br/>           1 double mirror door<br/>           6 glass shelves<br/>           1 shelf<br/>           5 shelves<br/>           mirrored back side<br/>           26,9 watt / converter 30 watt<br/>           2959 lumens / 3000 - 6500 Kelvin<br/>           with sensor for emotion lighting<br/>           This product contains a light source with<br/>           energy efficiency class: F</p> |  |                |                |                 |                          |       |  |  |  |  |
| <p><b>Central units</b><br/>           top cover has to be ordered separately</p>  |  |                |                |                 |                          |       |  |  |  |  |
|  <p>1280</p>  |  | 300            | 300            | 1280            | <b>M N A 8 1 3 0 7</b>   | L/R   |  |  |  |  |
| <p><b>medium-high unit</b><br/>           1 door with buffered closing<br/>           4 glass shelves</p>  |  |                |                |                 |                          |       |  |  |  |  |
|  <p>1280</p>  |  | 300            | 600            | 1280            | <b>M N A 8 1 6 0 7</b>   |       |  |  |  |  |
| <p><b>medium-high unit</b><br/>           2 doors with buffered closing<br/>           4 glass shelves</p>   |  |                |                |                 |                          |       |  |  |  |  |
|  <p>1280</p>  |  | 300            | 300            | 1280            | <b>M N A 8 4 3 0</b>     | L/R   |  |  |  |  |
| <p><b>medium-high unit with inside drawer</b><br/>           1 door with buffered closing<br/>           1 glass shelf (top)<br/>           2 inside drawers with buffered closing</p>   |  |                |                |                 |                          |       |  |  |  |  |
|  <p>1280</p>  |  | 300            | 600            | 1280            | <b>M N A 8 4 6 0</b>     |       |  |  |  |  |
| <p><b>medium-high unit with inside drawer</b><br/>           2 doors with buffered closing<br/>           1 continuous glass shelf<br/>           2 continuously inside metal-drawer with<br/>           buffered closing</p>  |  |                |                |                 |                          |       |  |  |  |  |

## b - straight - model list



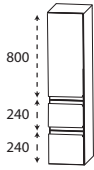
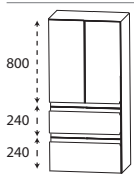
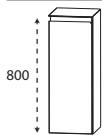
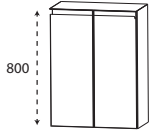
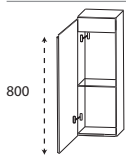

Depth indication corresponds to the carcass depth

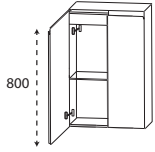
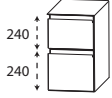
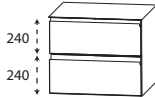
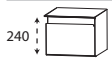
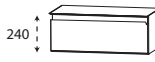
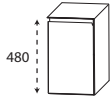
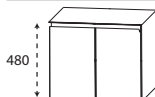
|   | Depth<br>in mm | Width<br>in mm | Height<br>in mm | Article number     | Hinge    |     |  |  |  |
|---|----------------|----------------|-----------------|--------------------|----------|-----|--|--|--|
| <b>Central units - top cover has to be ordered separately</b>   |                |                |                 |                    |          |     |  |  |  |
|   | 300            | 300            | 1280            | <b>MNA 8 7 3 0</b> | <b>4</b> | L/R |  |  |  |
| <b>medium-high unit</b><br>1 door with buffered closing<br>2 glass shelves (top)<br>2 metal pull outs with buffered closing and rail  |                |                |                 |                    |          |     |  |  |  |
|   | 300            | 600            | 1280            | <b>MNA 8 7 6 0</b> | <b>4</b> |     |  |  |  |
| <b>medium-high unit</b><br>2 doors with buffered closing<br>2 glass shelves (top)<br>2 metal pull outs with buffered closing and rail |                |                |                 |                    |          |     |  |  |  |
| <b>Highboards top cover has to be ordered separately</b>  |                |                |                 |                    |          |     |  |  |  |
|   | 300            | 300            | 800             | <b>HBA 5 1 3 0</b> |          | L/R |  |  |  |
| <b>Highboard</b><br>1 door with buffered closing<br>2 glass shelves   |                |                |                 |                    |          |     |  |  |  |
|   | 300            | 600            | 800             | <b>HBA 5 1 6 0</b> |          |     |  |  |  |
| <b>Highboard</b><br>2 doors with buffered closing<br>2 glass shelves  |                |                |                 |                    |          |     |  |  |  |
|   | 300            | 300            | 800             | <b>HBA 5 4 3 0</b> |          | L/R |  |  |  |
| <b>Highboard with inside drawer</b><br>1 door with buffered closing<br>1 inside drawer with buffered closing<br>1 glass shelf         |                |                |                 |                    |          |     |  |  |  |

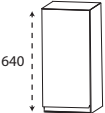
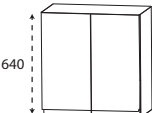

## b - straight - model list

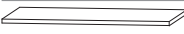
| Depth indication corresponds to the carcass depth                                   |  | Depth<br>in mm | Width<br>in mm | Height<br>in mm | Article number       | Hinge    |  |  |  |  |
|---|--|----------------|----------------|-----------------|----------------------|----------|--|--|--|--|
| <h3>Highboards - top cover has to be ordered separately</h3>                        |  |                |                |                 |                      |          |  |  |  |  |
|    | <b>Highboard with inside drawer</b><br>2 doors with buffered closing<br>1 consistent inside drawer with buffered closing<br>1 continuous glass shelf | 300            | 600            | 800             | <b>H B A 5 4 6 0</b> |          |  |  |  |  |
| <h3>Base units<br/>top cover has to be ordered separately</h3>                      |  |                |                |                 |                      |          |  |  |  |  |
|   | <b>Base unit</b><br>2 metal pull outs with buffered closing and rail   | 300            | 300            | 480             | <b>U N A 3 6 3 0</b> | <b>2</b> |  |  |  |  |
|  | <b>Base unit</b><br>2 metal pull outs with buffered closing and rail   | 300            | 600            | 480             | <b>U N A 3 6 6 0</b> | <b>2</b> |  |  |  |  |
|  | <b>Base unit</b><br>1 metal pull-out with buffered closing incl. drawer rail   | 300            | 300            | 240             | <b>U N A 1 1 3 0</b> | <b>2</b> |  |  |  |  |
|  | <b>Base unit</b><br>1 metal pull-out with buffered closing incl. drawer rail   | 300            | 600            | 240             | <b>U N A 1 1 6 0</b> | <b>2</b> |  |  |  |  |
|  | <b>Base unit</b><br>1 door with buffered closing<br>1 glass shelf  | 300            | 300            | 480             | <b>U N A 3 1 3 0</b> | L/R      |  |  |  |  |
|  | <b>Base unit</b><br>2 doors with buffered closing<br>1 glass shelf   | 300            | 600            | 480             | <b>U N A 3 1 6 0</b> |          |  |  |  |  |



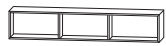

## b - straight - model list

| Depth indication corresponds to the carcass depth                                  |   | Depth<br>in mm | Width<br>in mm | Height<br>in mm | Article number         | Hinge |  |  |  |  |
|--|---|----------------|----------------|-----------------|------------------------|-------|--|--|--|--|
| <b>Wall units</b>  |   |                |                |                 |                        |       |  |  |  |  |
|    | <b>Wall unit</b><br>1 door with buffered closing<br>1 glass shelf   | 150            | 300            | 640             | <b>OGA 4 1 3 0</b>     | L/R   |  |  |  |  |
|    | <b>Wall unit</b><br>2 doors with buffered closing<br>1 glass shelf  | 150            | 600            | 640             | <b>OGA 4 1 6 0</b>     |       |  |  |  |  |
| <b>Counter tops</b>  |   |                |                |                 |                        |       |  |  |  |  |
|   | <b>top cover with ABS edge</b><br>only available in decor 185 natural oak effect<br><br><b>302 mm width</b><br><b>602 mm width</b>  | 330            | 302            | 28              | <b>APA 3 3 3 0 2 8</b> |       |  |  |  |  |
|  | <b>top cover lacquered with ABS edge</b><br>only available in 780 white lacque hgl. or 778 cosmos grey lacque matt<br><br><b>302 mm width</b><br><b>602 mm width</b>                                      | 325            | 302            | 22              | <b>APL 3 3 3 0 2 2</b> |       |  |  |  |  |
|  |   | 330            | 602            | 28              | <b>APA 3 3 6 0 2 8</b> |       |  |  |  |  |
|  |   | 325            | 602            | 22              | <b>APL 3 3 6 0 2 2</b> |       |  |  |  |  |
| <b>Shelves</b>   |   |                |                |                 |                        |       |  |  |  |  |
|  | <b>functional shelf</b><br>Edges are cut with a mitre<br>vertical and horizontal mounting possible<br><br>please indicate colour version:<br>no. 501 white matt lacquered<br>no. 547 black matt lacquered | 150            | 300            | 160             | <b>RGL 1 1 3 0 0 1</b> |       |  |  |  |  |
|  | <b>functional shelf</b><br>Edges are cut with a mitre<br>vertical and horizontal mounting possible<br><br>please indicate colour version:<br>no. 501 white matt lacquered<br>no. 547 black matt lacquered | 150            | 600            | 160             | <b>RGL 1 1 6 0 0 2</b> |       |  |  |  |  |





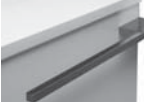

## b - straight - model list

| Depth indication corresponds to the carcass depth                                   | Depth in mm  | Width in mm | Height in mm | Article number | Hinge                    |  |
|---|--|-------------|--------------|----------------|--------------------------|--|
| <b>Shelves</b>  |  |             |              |                |                          |  |
|    | <b>functional shelf</b><br>Edges are cut with a mitre<br>vertical and horizontal mounting possible<br><br>please indicate colour version:<br>no. 501 white matt lacquered<br>no. 547 black matt lacquered  | 150         | 900          | 160            | <b>R G L 1 1 9 0 0 3</b> |  |
| <b>Glass shelves</b>  |  |             |              |                |                          |  |
|    | <b>Glass shelf</b><br>incl. metal holder<br><br><b>600 mm wide</b><br>incl. 2 metal brackets<br><br><b>900 mm wide</b><br>incl. 2 metal brackets<br><br><b>1200 mm wide</b><br>incl. 3 metal brackets<br><br><b>1400 mm wide</b><br>incl. 4 metal brackets   | 130         | 600          | 8              | <b>A B G 1 3 6 0 0 8</b> |  |
|   |  | 130         | 900          | 8              | <b>A B G 1 3 9 0 0 8</b> |  |
|   |  | 130         | 1200         | 8              | <b>A B G 1 3 1 2 0 8</b> |  |
|   |  | 130         | 1400         | 8              | <b>A B G 1 3 1 4 0 8</b> |  |
| <b>Push- fit shelf</b>  |  |             |              |                |                          |  |
|  | <b>Push-fit shelf</b><br>with ABS thick edge all around<br>incl. holders for push fit shelf<br><br><b>300 mm wide</b><br>incl. 2 push-fit holder<br><br><b>600 mm wide</b><br>incl. 2 push-fit holder<br><br><b>900 mm wide</b><br>incl. 3 push-fit holder<br><br><b>1200 mm wide</b><br>incl. 3 push-fit holder<br><br><b>1400 mm wide</b><br>incl. 3 push-fit holder | 150         | 300          | 28             | <b>S B G 6 0 3 0</b>     |  |
|   |  | 150         | 600          | 28             | <b>S B G 6 0 6 0</b>     |  |
|   |  | 150         | 900          | 28             | <b>S B G 6 0 9 0</b>     |  |
|   |  | 150         | 1200         | 28             | <b>S B G 6 0 1 2</b>     |  |
|   |  | 150         | 1400         | 28             | <b>S B G 6 0 1 4</b>     |  |











## b - straight - model list

| Depth indication corresponds to the carcass depth                                  |  | Depth<br>in mm | Width<br>in mm | Height<br>in mm | Article number           |  |  | Hinge |  |  |  |  |  |
|--|--|----------------|----------------|-----------------|--------------------------|--|--|-------|--|--|--|--|--|
| <b>Accessories</b>   |  |                |                |                 |                          |  |  |       |  |  |  |  |  |
|    | <p><b>Towel holder</b><br/>one-armed<br/>front opened<br/>for assembling at the washbasin base unit<br/>Please observe carcass depth and furniture height</p> <p>Chrome hgl.<br/>black</p> | 390<br>390     | 55<br>55       | 30<br>30        | <b>P Z</b><br><b>P Z</b> | <b>1 1 2 8 1 1</b><br><b>1 1 2 8 1 2</b> |  |       |  |  |  |  |  |
|    | <p><b>Towel holder</b><br/>two-armed<br/>front opened<br/>for assembling at the washbasin base unit<br/>Please observe carcass depth and furniture height</p> <p>Chrome hgl.<br/>black</p> | 390<br>390     | 110<br>110     | 30<br>30        | <b>P Z</b><br><b>P Z</b> | <b>1 1 2 8 1</b><br><b>1 1 2 8 2</b>     |  |       |  |  |  |  |  |
|  | <p><b>Towel holder</b><br/>one-armed<br/>swiveling<br/>for mounting to wall or carcass<br/>Please observe carcass depth and furniture height</p> <p>Chrome hgl.<br/>black</p>              | 420<br>420     | 30<br>30       | 46<br>46        | <b>P Z</b><br><b>P Z</b> | <b>1 1 4 7 1</b><br><b>1 1 4 7 2</b>     |  |       |  |  |  |  |  |
|  | <p><b>Towel holder</b><br/>one-armed<br/>extendable<br/>chrome gloss<br/>wall-mounted</p>  | 330-567        | 44             | 44              | <b>P Z</b>               | <b>1 1 3 7 1</b>                         |  |       |  |  |  |  |  |
|  | <p><b>Towel holder</b><br/>two-armed<br/>extendable<br/>chrome gloss<br/>wall-mounted</p>  | 322-562        | 87             | 47              | <b>P Z</b>               | <b>1 1 3 7 2</b>                         |  |       |  |  |  |  |  |
|  | <p><b>Towel holder</b><br/>chrome gloss<br/>to fit on carcass at side<br/>front opened</p> <p>Please observe carcass depth and furniture height</p>  | 390            | 60             |                 | <b>P Z</b>               | <b>1 1 2 4 1</b>                         |  |       |  |  |  |  |  |

## b - straight - model list







| Depth indication corresponds to the carcass depth                                   |   | Depth<br>in mm | Width<br>in mm | Height<br>in mm | Article number |             |  | Hinge |  |  |  |  |
|---|---|----------------|----------------|-----------------|----------------|-------------|--|-------|--|--|--|--|
| <b>Accessories</b>  |   |                |                |                 |                |             |  |       |  |  |  |  |
|    | <p><b>Adjustable organizer components</b></p> <p>not possible for variant 560</p> <p>2 dividing elements - 300 mm cabinet width</p> <p>4 dividing elements - 600 mm cabinet width</p> <p>4 dividing elements - 900 mm cabinet width</p> <p>6 dividing elements - 1200 mm cabinet width</p> <p>7 dividing elements - 1400 mm cabinet width</p> |                |                |                 | P Z            | 1 2 2 4 3 0 |  |       |  |  |  |  |
|   | <p><b>Basin organizer</b><br/>without fitting elements</p>  | 150            | 246            | 150             | P Z            | 1 2 3 6 E 1 |  |       |  |  |  |  |
|  | <p><b>Basin organizer incl. fixing elements</b></p> <p>2 basin organizer for 600 mm cabinet width</p> <p>2 basin organizer for 900 mm cabinet width</p> <p>2 basin organizer for 1200 mm cabinet width</p> <p>2 basin organizer for 1400 mm cabinet width</p> <p>not possible for variant 560</p>   |                |                |                 | P Z            | 1 2 3 6 6 0 |  |       |  |  |  |  |
|  | <p><b>Drawer set for metal drawers</b><br/>for 30 cm wide cabinets<br/>Consisting of:<br/>- 1 aluminium-coloured plastic insert<br/>- 2 aluminium coloured dividers, adjustable</p>   |                |                |                 | P Z            | 1 2 2 5 3 0 |  |       |  |  |  |  |
|  | <p><b>Design installation-set chrome</b><br/>1 design syphon<br/>2 design-angle valves<br/>2 design connection pipes M10</p>  |                |                |                 | P Z            | 1 3 8 9 1 E |  |       |  |  |  |  |
|  | <p><b>Design syphon</b><br/>chrome gloss<br/>for free hanging washbasin</p>   |                |                |                 | P Z            | 1 3 7 4 1   |  |       |  |  |  |  |
|  | <p><b>Design syphon</b><br/>black matt<br/>for free hanging washbasin</p>   |                |                |                 | P Z            | 1 3 7 4 3 0 |  |       |  |  |  |  |

## b - straight - model list

| Depth indication corresponds to the carcass depth   |  | Depth<br>in mm | Width<br>in mm | Height<br>in mm | Article number |                |            | Hinge |  |  |  |  |  |
|---|--|----------------|----------------|-----------------|----------------|----------------|------------|-------|--|--|--|--|--|
|  <p><b>Emotion lighting</b><br/>sensor switcher<br/>for dimming and for colour change control<br/><br/>for all identified cabinets</p>    |  |                |                |                 | <b>P Z</b>     | <b>1 0 2 0</b> | <b>1</b>   |       |  |  |  |  |  |
|  <p><b>USB socket element</b><br/>2 plus-in slots<br/>connection 220 V with clamp<br/><br/>installed in mirror cabinet<br/>please state position<br/><br/>not installed in mirror cabinet</p>   |  | 45             | 80             | 64              | <b>P Z</b>     | <b>1 1 5 1</b> | <b>E B</b> |       |  |  |  |  |  |
|  <p><b>LED washbasin lighting emotion</b><br/>2,6 Watt / 187 lumens / (2700 -) 6500<br/>Kelvin<br/>1 switch element<br/>IED converter<br/>This product contains a light source with<br/>energy efficiency class: G<br/><br/>LED mood lighting available as an option</p>     |  | 16             | 560            | 7               | <b>P Z</b>     | <b>1 1 5 0</b> | <b>6 0</b> |       |  |  |  |  |  |
|  <p><b>LED washbasin lighting emotion</b><br/>4,0 Watt / 287 lumens / (2700 -) 6500<br/>Kelvin<br/>1 switch element<br/>IED converter<br/>This product contains a light source with<br/>energy efficiency class: G<br/><br/>LED mood lighting available as an option</p>  |  | 16             | 860            | 7               | <b>P Z</b>     | <b>1 1 5 0</b> | <b>9 0</b> |       |  |  |  |  |  |
|  <p><b>LED washbasin lighting emotion</b><br/>5,4 watt / 388 lumens / (2700 -) 6500<br/>Kelvin<br/>1 switch element<br/>IED converter<br/>This product contains a light source with<br/>energy efficiency class: G<br/><br/>LED mood lighting available as an option</p>  |  | 16             | 1160           | 7               | <b>P Z</b>     | <b>1 1 5 0</b> | <b>1 2</b> |       |  |  |  |  |  |
|  <p><b>LED washbasin lighting</b><br/>2,4 Watt / 168 lumens / 6500 Kelvin<br/>1 switch element<br/>to fit underneath mirror cabinet<br/>This product contains a light source with<br/>energy efficiency class: G<br/><br/>not suitable with Emotion lighting</p>  |  | 10             | 560            | 10              | <b>P Z</b>     | <b>1 0 6 3</b> | <b>6 0</b> |       |  |  |  |  |  |



## b - straight - model list

| Depth indication corresponds to the carcass depth                                   |   | Depth<br>in mm | Width<br>in mm | Height<br>in mm | Article number |             |  | Hinge |  |  |  |  |
|---|---|----------------|----------------|-----------------|----------------|-------------|--|-------|--|--|--|--|
| <b>Accessories</b>  |   |                |                |                 |                |             |  |       |  |  |  |  |
|    | <p><b>LED washbasin lighting</b><br/>3,9 Watt / 287 lumens / 6500 Kelvin<br/>1 switch element<br/>to fit underneath mirror cabinet<br/>This product contains a light source with energy efficiency class: G</p> <p>not suitable with Emotion lighting</p> | 10             | 860            | 10              | P Z            | 1 0 6 3 9 0 |  |       |  |  |  |  |
|    | <p><b>LED washbasin lighting</b><br/>5,3 Watt / 371 lumens / 6500 Kelvin<br/>1 switch element<br/>to fit underneath mirror cabinet<br/>This product contains a light source with energy efficiency class: G</p> <p>not suitable with Emotion lighting</p> | 10             | 1160           | 10              | P Z            | 1 0 6 3 1 2 |  |       |  |  |  |  |
|  | <p><b>Remote switch incl. receiver</b><br/>for LED lighting<br/>for dimming and for colour change control<br/>Reach up to 5 meters</p> <p>not suitable for LED converter over 30 watt</p>   |                | 85             | 85              | P Z            | 1 1 4 3     |  |       |  |  |  |  |
|  | <p><b>Motion sensor</b><br/>for LED lighting of washbasins or washbasin base units<br/>Term and sensitivity of lighting are adjustable</p>  |                |                |                 | P Z            | 1 1 4 1     |  |       |  |  |  |  |
|  | <p><b>Space-saving drain stretch trap from GEBERIT</b><br/>made of plastic, in white<br/>nominal diameter: 40</p>   |                |                |                 | P Z            | 1 3 6 7     |  |       |  |  |  |  |
|  | <p><b>Space-saving drain stretch trap from GEBERIT</b><br/>made of plastic, in white<br/>nominal diameter: 32</p>   |                |                |                 | P Z            | 1 4 2 3     |  |       |  |  |  |  |

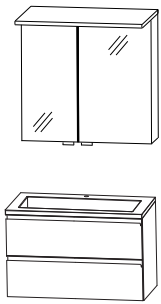
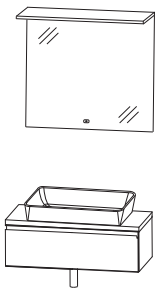
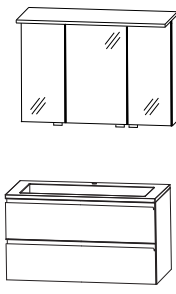
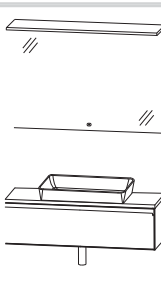

## b - straight - bathroom variations

|                   |                                     |  |             |                   |
|-------------------|-------------------------------------|--|-------------|-------------------|
| <b>BSM-0160-5</b> |                                     |    | 600 mm wide |                   |
| 1                 | Mirror cabinet, 600 mm              |  |             | S 2 A 4 3 6 0 8 8 |
| 1                 | Washbasin base unit                 |  |             | W U A 3 3 6 0 1 0 |
| 1                 | cast mineral washbasin, LED, 600 mm |  |             | S W M 9 3 0 6 B 1 |
| <b>BSM-0160-6</b> |                                     |    | 600 mm wide |                   |
| 1                 | Mirror 600 mm                       |  |             | F S B 4 1 6 0 0 1 |
| 1                 | Washbasin base unit                 |  |             | W U A 1 1 6 0 1 6 |
| 1                 | cast mineral washbasin, LED, 600 mm |  |             | M W P 1 0 6 M B 1 |
| 1                 | Design syphon                       | P Z 1 3 7 4 1  |             |                   |
| <b>BSM-0190-5</b> |                                     |   | 900 mm wide |                   |
| 1                 | Mirror cabinet, 900 mm              |  |             | S 2 A 4 3 9 0 8 8 |
| 1                 | Washbasin base unit                 |  |             | W U A 3 3 9 0 1 0 |
| 1                 | Cast mineral washbasin, LED, 900 mm |  |             | S W M 9 3 0 9 B 1 |
| <b>BSM-0190-6</b> |                                     |  | 900 mm wide |                   |
| 1                 | Mirror 900 mm                       |  |             | F S B 4 1 9 0 0 1 |
| 1                 | Washbasin base unit                 |  |             | W U A 1 1 9 0 1 6 |
| 1                 | Cast mineral washbasin, LED, 900 mm |  |             | M W P 1 0 9 M B 1 |
| 1                 | Design syphon                       | P Z 1 3 7 4 1  |             |                   |

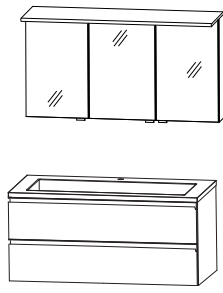
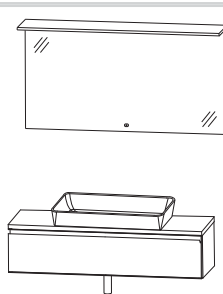
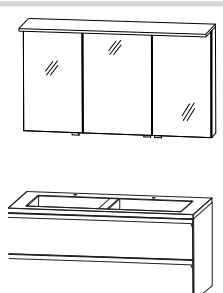
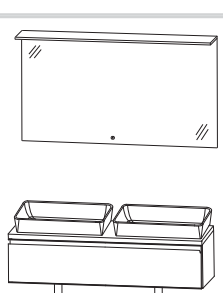
## b - straight - bathroom variations

|                    |                                      |   |
|--------------------|--------------------------------------|---|
| <b>BSM-0112-5</b>  |                                      |    |
| 1                  | Mirror cabinet, 1200 mm              |   |
| 1                  | Washbasin base unit                  | W U A 3 3 1 2 1 0   |
| 1                  | cast mineral washbasin, LED, 1200 mm | S W M 9 3 1 2 B 1   |
|                    |                                      | 1200 mm wide  |
| <b>BSM-0112-6</b>  |                                      |    |
| 1                  | Mirror 1200 mm                       |   |
| 1                  | Washbasin base unit                  | W U A 1 1 1 2 1 6   |
| 1                  | cast mineral washbasin, LED, 1200 mm | M W P 1 1 2 M B 1   |
| 1                  | Design syphon                        | P Z 1 3 7 4 1   |
|                    |                                      | 1200 mm wide  |
| <b>BSM-0112-D5</b> |                                      |   |
| 1                  | Mirror cabinet, 1200 mm              |   |
| 1                  | Washbasin base unit                  | W U A 3 3 1 2 1 2   |
| 1                  | cast mineral washbasin, LED, 1200 mm | S W M 9 3 2 D B 1   |
|                    | Double washbasin                     |   |
|                    |                                      | 1200 mm wide  |
| <b>BSM-0112-D6</b> |                                      |  |
| 1                  | Mirror 1200 mm                       |   |
| 1                  | Washbasin base unit                  | W U A 1 1 1 2 1 7   |
| 1                  | cast mineral washbasin, LED, 1200 mm | M W P 1 1 2 D B 1   |
| 2                  | Design syphon                        | P Z 1 3 7 4 1   |
|                    |                                      | 1200 mm wide  |

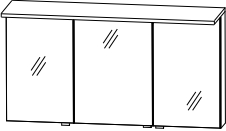
## b - straight - bathroom variations

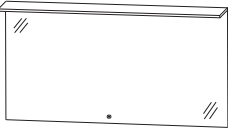
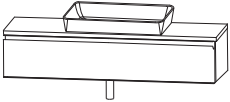
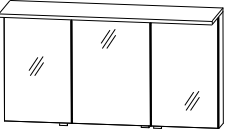
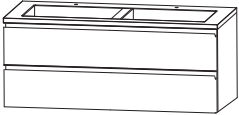
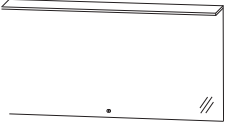
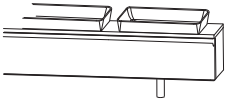
|                    |                                      |                   |  |
|--------------------|--------------------------------------|-------------------|--|
| <b>BSM-0114-5</b>  |                                      |                   |  |
| 1                  | Mirror cabinet, 1400 mm              | S 2 A 4 3 1 4 8 8 | <br><br>1400 mm wide     |
| 1                  | Washbasin base unit                  | W U A 3 3 1 4 1 0 |  |
| 1                  | cast mineral washbasin, LED, 1400 mm | S W M 9 3 1 4 B 1 |  |
| <b>BSM-0114-6</b>  |                                      |                   |  |
| 1                  | Mirror 1400 mm                       | F S B 4 1 1 4 0 1 | <br><br>1400 mm wide     |
| 1                  | Washbasin base unit                  | W U A 1 1 1 4 1 6 |  |
| 1                  | cast mineral washbasin, LED, 1400 mm | M W P 1 1 4 M B 1 |  |
| 1                  | Design syphon                        | P Z 1 3 7 4 1     |  |
| <b>BSM-0114-D5</b> |                                      |                   |  |
| 1                  | Mirror cabinet, 1400 mm              | S 2 A 4 3 1 4 8 8 | <br><br>1400 mm wide |
| 1                  | Washbasin base unit                  | W U A 3 3 1 4 1 2 |  |
| 1                  | cast mineral washbasin, LED, 1400 mm | S W M 9 3 4 D B 1 |  |
|                    | Double washbasin                     |                   |  |
| <b>BSM-0114-D6</b> |                                      |                   |  |
| 1                  | Mirror 1400 mm                       | F S B 4 1 1 4 0 1 | <br><br>1400 mm wide |
| 1                  | Washbasin base unit                  | W U A 1 1 1 4 1 7 |  |
| 1                  | cast mineral washbasin, LED, 1400 mm | M W P 1 1 4 D B 1 |  |
| 2                  | Design syphon                        | P Z 1 3 7 4 1     |  |

## b - straight - dimensional drawings

SWM 9306 + WUA 1160 10

SWM 9306 + WUA 3360 10

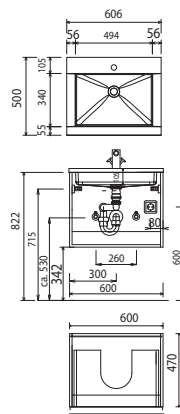
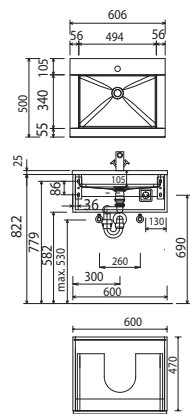

SWM 9309 + WUA 1190 10

SWM 9309 + WUA 3390 10

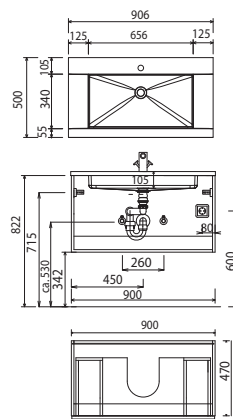
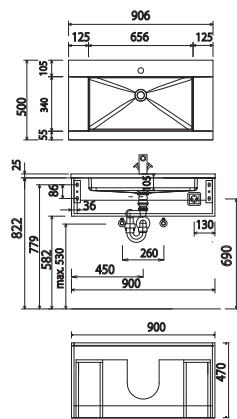

SWM 9312 + WUA 1112 10

SWM 9312 + WUA 3312 10

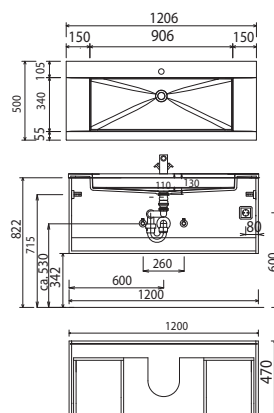
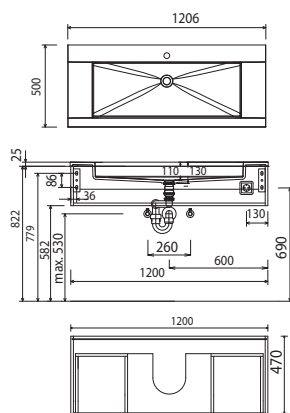

For washing stands with fixing screws, the dimensions for boring must be drawn in on-site after the washing stand has been laid on the floor unit.

**Washing stands without anchoring brackets have to be fixed on the wall and on the furniture-side with silicon!**

Cast mineral:

The water temperature must not exceed 55° C / 131° F. Hair tinting lotions have to be removed immediately, so that staining can be avoided.

Modifications:

Technical modifications (+/- 5mm) and flatness modifications (DIN 18202) are subject of the usual material-specific modifications for construction materials, based on DIN 18202.

## b - straight - dimensional drawings

SWM 932D + WUA 1112 12

SWM 932D + WUA 3312 12

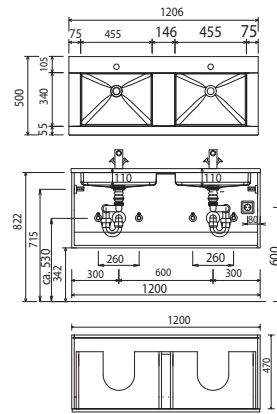
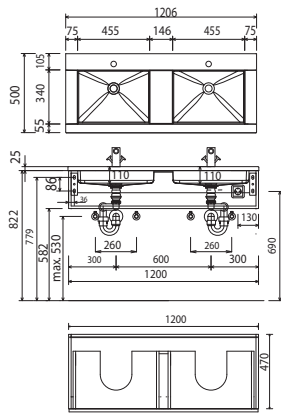

SWM 9314 + WUA 1114 10

SWM 9314 + WUA 3314 10

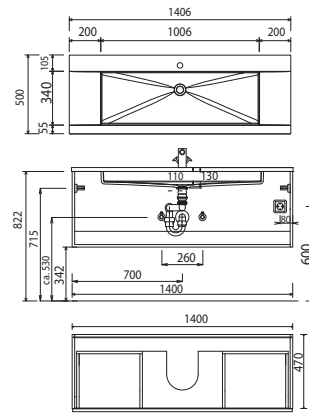
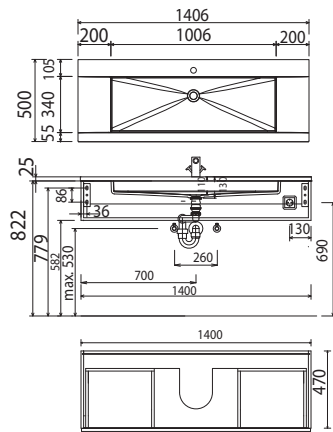

SWM 934D + WUA 1114 12

SWM 934D + WUA 3314 12

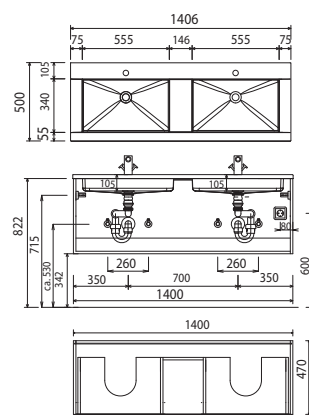
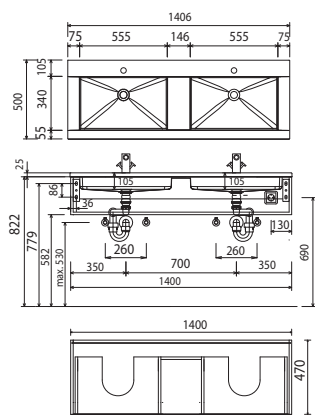

For washing stands with fixing screws, the dimensions for boring must be drawn in on-site after the washing stand has been laid on the floor unit.

**Washing stands without anchoring brackets have to be fixed on the wall and on the furniture-side with silicon!**

Cast mineral:

The water temperature must not exceed 55° C / 131° F. Hair tinting lotions have to be removed immediately, so that staining can be avoided.

Modifications:

Technical modifications (+/- 5mm) and flatness modifications (DIN 18202) are subject of the usual material-specific modifications for construction materials, based on DIN 18202.

## b . straight - dimensional drawings

MWP 106M + WUA 1160 16

MWP 106M + WUA 3360 16

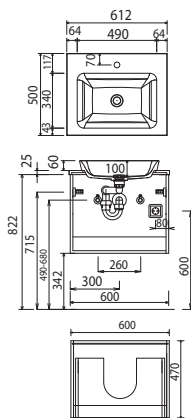
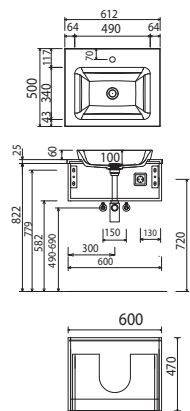

MWP 109M + WUA 1190 16

MWP 109M + WUA 3390 16

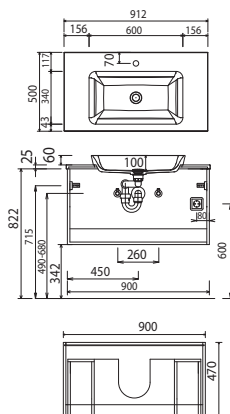
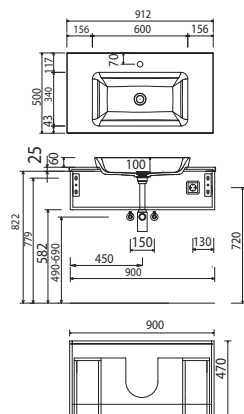

MWP 112M + WUA 1112 16

MWP 112M + WUA 3312 16

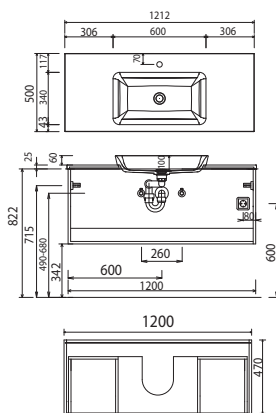
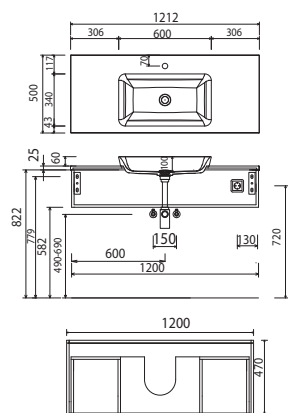

For washing stands with fixing screws, the dimensions for boring must be drawn in on-site after the washing stand has been laid on the floor unit.

**Washing stands without anchoring brackets have to be fixed on the wall and on the furniture-side with silicon!**

Cast mineral:

The water temperature must not exceed 55° C / 131° F. Hair tinting lotions have to be removed immediately, so that staining can be avoided.

Modifications:

Technical modifications (+/- 5mm) and flatness modifications (DIN 18202) are subject of the usual material-specific modifications for construction materials, based on DIN 18202.

## b - straight - dimensional drawings

MWP 112D + WUA 1112 17

MWP 112D + WUA 3312 17

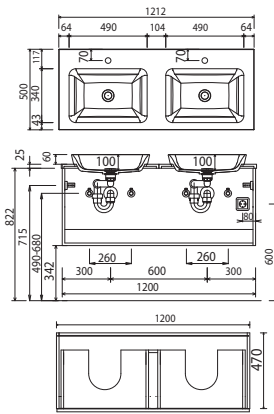
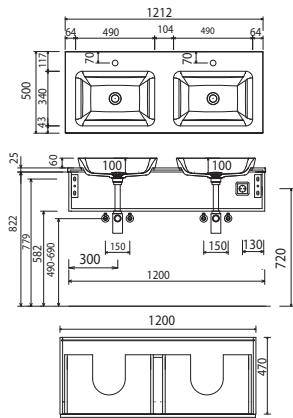

MWP 114M + WUA 1114 16

MWP 114M + WUA 3314 16

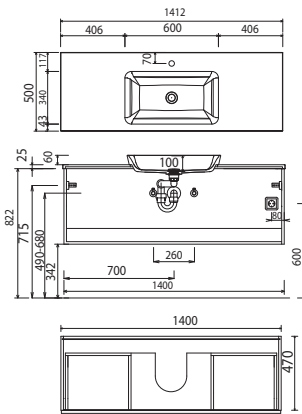
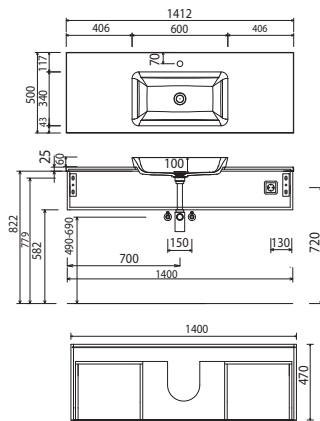

MWP 114D + WUA 1114 17

MWP 114D + WUA 3314 17

electrical connections for mirror cabinets

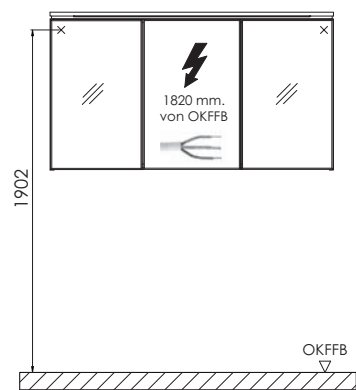
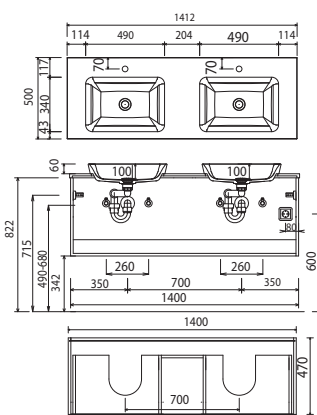
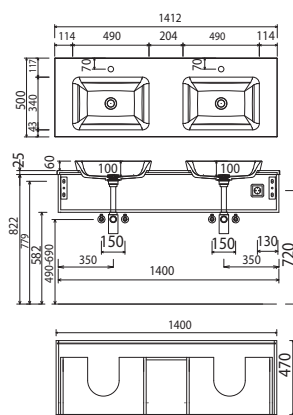

For washing stands with fixing screws, the dimensions for boring must be drawn in on-site after the washing stand has been laid on the floor unit.

**Washing stands without anchoring brackets have to be fixed on the wall and on the furniture-side with silicon!**

Cast mineral:

The water temperature must not exceed 55° C / 131° F. Hair tinting lotions have to be removed immediately, so that staining can be avoided.

Modifications:

Technical modifications (+/- 5mm) and flatness modifications (DIN 18202) are subject of the usual material-specific modifications for construction materials, based on DIN 18202.