



## Front colours



No. 764 Stonegrey matt



No. 777 cosmos grey matt



No. 793 noble white matt



No. 891 quarz grey matt



No. 893 titanium grey matt



No. 686 anthracite hgl.



No. 722 polar white hgl.



no. 680 Charleston oak



Nr. 785 natural oak



no. 794 sand oak

**F** foiled front



























# Program 040 - type list

	Depth in mm	Width in mm	Height in mm	Article number	Hinge	Surcharge high-gloss carcass
Depth indication corresponds to the carcass depth						
<b>Tall units</b>						
<p><b>Tall unit with laundry basket</b>            2 doors            2 glass shelves            1 drawer with buffered closing            1 laundry basket with wire basket            1 top cover 330 mm deep            Volume of laundry basket: 55 liters</p>	300	600	1628	<b>H N A 0 5 6 A 7 W</b>		
<p><b>Tall unit with laundry basket</b>            1 aluminium framed door with satined glass            2 glass shelves            1 drawer with buffered closing            1 laundry basket with wire basket            1 top cover 330 mm deep            Volume of laundry basket: 25 liters</p>	300	300	1628	<b>H N A 0 5 3 B 7 W</b>	L/R	
<p><b>Tall unit with laundry basket</b>            2 aluminium framed doors with satined glass            2 glass shelves            1 drawer with buffered closing            1 laundry basket with wire basket            1 top cover 330 mm deep            Volume of laundry basket: 55 liters</p>	300	600	1628	<b>H N A 0 5 6 B 7 W</b>		
<p><b>Tall unit with laundry pull out</b>            2 doors            2 glass shelves (top)            1 drawer with buffered closing            2 doors            1 laundry pull out with wire basket            1 top cover 330 mm deep            Volume of laundry pull out: 40 liters</p>	300	600	1628	<b>H N A 0 5 6 A 1 W</b>		
<b>Tall unit-shelf</b>						
<p><b>Tall unit-shelf</b>            with open shelf space            in carcass colour</p>	150	300	1600	<b>R G 1 0 3 0 0 1</b>		

Please observe suitable accessories in the separate index.

# Programm 040 - type list

Depth indication corresponds to the carcass depth

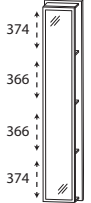
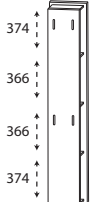
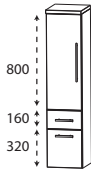
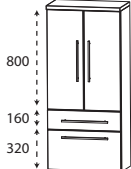
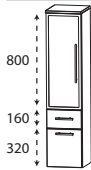
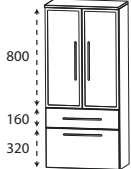
	Depth in mm	Width in mm	Height in mm	Article number	Hinge	Surcharge high-gloss carcass
<b>Tall unit-shelf</b>						
 <p>374 366 366 374</p>	150	300	1600	<b>R G 1 0 3 0 0 2</b>		
 <p>374 366 366 374</p>	150	300	1600	<b>R G 1 0 3 0 0 3</b>		
<b>Central units</b>						
 <p>800 160 320</p>	300	300	1308	<b>M N A 8 8 3 A 7 M</b>	L/R	
	300	400	1308	<b>M N A 8 8 4 A 7 M</b>	L/R	
 <p>800 160 320</p>	300	600	1308	<b>M N A 8 8 6 A 7 M</b>		
 <p>800 160 320</p>	300	300	1308	<b>M N A 8 8 3 B 7 M</b>	L/R	
 <p>800 160 320</p>	300	600	1308	<b>M N A 8 8 6 B 7 M</b>		

Please observe suitable accessories in the separate index.

# Program 040 - type list

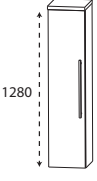
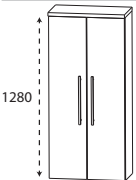
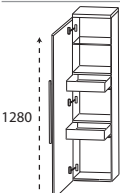
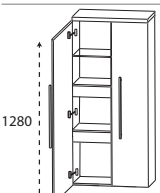
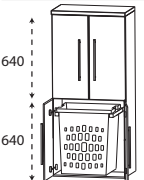
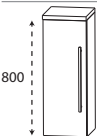
Depth indication corresponds to the carcass depth		Depth in mm	Width in mm	Height in mm	Article number		Hinge	Surcharge high-gloss carcass
<b>Central units</b>								
 <p>1280</p>	<b>medium-high unit</b> 1 door 4 glass shelves 1 top cover 330 mm deep  Variable in width: please quote the exact dimension of carcass depth. Top cover will be adapted to the cupboard width.	300	300	1308	<b>M N A 8 1 3 A</b>	7	L/R	
		300	400	1308	<b>M N A 8 1 4 A</b>	7	L/R	
		150-299	300	1308	<b>M V A 8 1 3 0</b>		L/R	
		150-299	400	1308	<b>M V A 8 1 4 0</b>		L/R	
 <p>1280</p>	<b>medium-high unit</b> 2 doors 4 glass shelves 1 top cover 330 mm deep  Variable in width: please quote the exact dimension of carcass depth. Top cover will be adapted to the cupboard width.	300	600	1308	<b>M N A 8 1 6 A</b>	7		
		150-299	600	1308	<b>M V A 8 1 6 0</b>			
 <p>1280</p>	<b>medium-high unit with inside drawers</b> 1 door 2 inside metal-drawer with buffered closing 1 glass shelf 1 top cover 330 mm deep	300	300	1308	<b>M N A 8 4 3 A</b>	7	L/R	
		300	400	1308	<b>M N A 8 4 4 A</b>	7	L/R	
 <p>1280</p>	<b>medium-high unit with inside drawers</b> 2 doors 2 continuously inside metal-drawer with buffered closing 1 continuous glass shelf 1 top cover 330 mm deep	300	600	1308	<b>M N A 8 4 6 A</b>	7		
 <p>640</p> <p>640</p>	<b>medium-high unit with laundry pull out</b> 2 doors 1 glass shelf (top) 2 doors 1 laundry pull out with wire basket Volume of laundry pull out: 40 liters 1 top cover 330 mm deep	300	600	1308	<b>M N A 8 3 6 A</b>	<b>1 W</b>		
<b>Highboards</b>								
 <p>800</p>	<b>Highboard</b> 1 door 2 glass shelves 1 top cover 330 mm deep  Variable in width: please quote the exact dimension of carcass depth. Top cover will be adapted to the cupboard width.	300	300	828	<b>H B A 5 1 3 A</b>	7	L/R	
		300	400	828	<b>H B A 5 1 4 A</b>	7	L/R	
		150-299	300	828	<b>H B V A 5 1 3</b>		L/R	
		150-299	400	828	<b>H B V A 5 1 4</b>		L/R	

Please observe suitable accessories in the separate index.

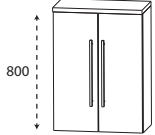
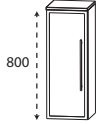
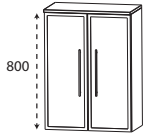
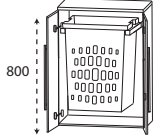
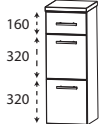
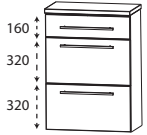
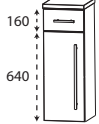
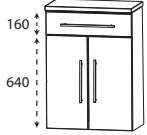

# Program 040 - type list

Depth indication corresponds to the carcass depth		Depth in mm	Width in mm	Height in mm	Article number		Hinge	Surcharge high-gloss carcass
 <p>800</p>	<b>Highboard</b> 2 doors 2 glass shelves 1 top cover 330 mm deep	300	600	828	<b>H B A 5 1 6 A</b>	<b>7</b>		
	Variable in width: please quote the exact dimension of carcass depth. Top cover will be adapted to the cupboard width.	150-299	600	828	<b>H B V A 5 1 6</b>			
 <p>800</p>	<b>Highboard</b> 1 aluminium framed door with satined glass 2 glass shelves 1 top cover 330 mm deep	300	300	828	<b>H B A 5 1 3 B</b>	<b>7</b>	L/R	
	Variable in width: please quote the exact dimension of carcass depth. Top cover will be adapted to the cupboard width.	150-299	300	828	<b>H B V A 5 1 3</b>	<b>1</b>	L/R	
 <p>800</p>	<b>Highboard</b> 2 aluminium framed doors with satined glass 2 glass shelves 1 top cover 330 mm deep	300	600	828	<b>H B A 5 1 6 B</b>	<b>7</b>		
	Variable in width: please quote the exact dimension of carcass depth. Top cover will be adapted to the cupboard width.	150-299	600	828	<b>H B V A 5 1 6</b>	<b>1</b>		
 <p>800</p>	<b>Highboard with laundry pull out</b> 2 doors 1 laundry pull out with wire basket 1 top cover 330 mm deep  Volume of laundry pull out: 40 liters	300	600	828	<b>H B A 5 1 6 A</b>	<b>1 W</b>		
 <p>160 320 320</p>	<b>Highboard</b> 1 drawer with buffered closing 2 metal pull-outs with buffered closing 1 top cover 330 mm deep	300	300	828	<b>H B A 5 6 3 A</b>	<b>7 M</b>		
		300	400	828	<b>H B A 5 6 4 A</b>	<b>7 M</b>		
 <p>160 320 320</p>	<b>Highboard</b> 1 drawer with buffered closing 2 metal pull-outs with buffered closing 1 top cover 330 mm deep	300	600	828	<b>H B A 5 6 6 A</b>	<b>7 M</b>		
 <p>160 640</p>	<b>Highboard</b> 1 drawer with buffered closing 1 door 1 glass shelf 1 top cover 330 mm deep	300	300	828	<b>H B A 5 5 3 A</b>	<b>7 M</b>	L/R	
		300	400	828	<b>H B A 5 5 4 A</b>	<b>7 M</b>	L/R	
 <p>160 640</p>	<b>Highboard</b> 1 drawer with buffered closing 2 doors 1 glass shelf 1 top cover 330 mm deep	300	600	828	<b>H B A 5 5 6 A</b>	<b>7 M</b>		



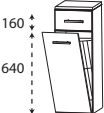
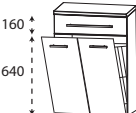
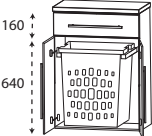
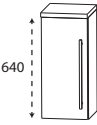
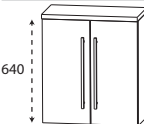
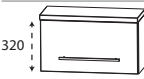

Please observe suitable accessories in the separate index.

# Program 040 - type list

Depth indication corresponds to the carcass depth		Depth in mm	Width in mm	Height in mm	Article number	Hinge	Surcharge high-gloss carcass
<b>Highboards</b>							
	<b>Highboard with laundry basket</b> 1 drawer with buffered closing 1 laundry basket with wire basket 1 top cover 330 mm deep  Volume of laundry basket: 25 liters	300	300	828	<b>H B A 5 5 3 A 7 W</b>		
	Volume of laundry basket: 35 liters	300	400	828	<b>H B A 5 5 4 A 7 W</b>		
	<b>Highboard with laundry basket</b> 1 drawer with buffered closing 1 laundry basket with wire basket 1 top cover 330 mm deep  Volume of laundry basket: 55 liters	300	600	828	<b>H B A 5 5 6 A 7 W</b>		
	<b>Highboard with laundry pull out</b> 1 drawer with buffered closing 2 doors 1 laundry pull out with wire basket 1 top cover 325 mm deep  Volume of laundry pull out: 40 liters	300	600	828	<b>H B A 5 5 6 A 1 W</b>		
<b>Wall units</b>							
	<b>Wall unit</b> 1 door 1 glass shelf 1 top cover 180 mm deep  Variable in width: please quote the exact dimension of carcass depth. Top cover will be adapted to the cupboard width.	150	300	668	<b>O G A 4 1 3 A</b>	7	L/R
		150	400	668	<b>O G A 4 1 4 A</b>	7	L/R
		151-300	300	668	<b>O V A 4 1 3 0</b>		L/R
		151-300	400	668	<b>O V A 4 1 4 0</b>		L/R
	<b>Wall unit</b> 2 doors 1 glass shelf 1 top cover 180 mm deep  Variable in width: please quote the exact dimension of carcass depth. Top cover will be adapted to the cupboard width.	150	600	668	<b>O G A 4 1 6 A</b>	7	
151-300		600	668	<b>O V A 4 1 6 0</b>			
	<b>Wall unit</b> 1 flap door, 1 top cover 260 mm deep	230	600	348	<b>O M A 2 1 6 A</b>	7	K

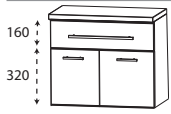

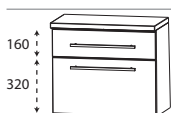
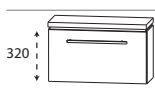
Please observe suitable accessories in the separate index.

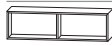
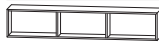
# Program 040 - type list

Depth indication corresponds to the carcass depth		Depth in mm	Width in mm	Height in mm	Article number	Hinge	Surcharge high-gloss carcass
<b>Base units</b>							
	<b>Base unit</b> 1 drawer with buffered closing 1 door 1 top cover 330 mm deep	300	300	508	<b>U N A 3 2 3 A 7 M</b>	L/R	
		300	400	508	<b>U N A 3 2 4 A 7 M</b>	L/R	
	<b>Base unit</b> 1 drawer with buffered closing 2 doors 1 top cover 330 mm deep	300	600	508	<b>U N A 3 2 6 A 7 M</b>		
	<b>Base unit</b> 1 drawer with buffered closing 1 metal pull-out with buffered closing, 1 top cover 330 mm deep	300	300	508	<b>U N A 3 4 3 A 7 M</b>		
		300	400	508	<b>U N A 3 4 4 A 7 M</b>		
	<b>Base unit</b> 1 drawer with buffered closing 1 metal pull-out with buffered closing, 1 top cover 330 mm deep	300	600	508	<b>U N A 3 4 6 A 7 M</b>		
	<b>Base unit</b> 1 flap door, 1 top cover 260 mm deep	230	600	348	<b>U M A 2 1 6 A 7 K</b>		
<b>Shelves</b>							
	<b>functional shelf</b> Edges are cut with a mitre vertical and horizontal mounting possible  please indicate colour version: no. 501 white matt lacquered no. 547 black matt lacquered	150	300	160	<b>R G L 1 1 3 0 0 1</b>		
	<b>functional shelf</b> Edges are cut with a mitre vertical and horizontal mounting possible  please indicate colour version: no. 501 white matt lacquered no. 547 black matt lacquered	150	600	160	<b>R G L 1 1 6 0 0 2</b>		
	<b>functional shelf</b> Edges are cut with a mitre vertical and horizontal mounting possible  please indicate colour version: no. 501 white matt lacquered no. 547 black matt lacquered	150	900	160	<b>R G L 1 1 9 0 0 3</b>		

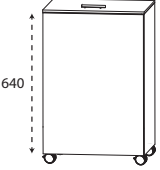
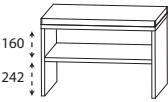
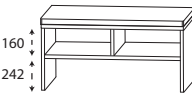

Please observe suitable accessories in the separate index.

# Program 040 - type list

Depth indication corresponds to the carcass depth		Depth in mm	Width in mm	Height in mm	Article number	Hinge	Surcharge high-gloss carcass
<h2>Laundryrolli</h2>  <p><b>Laundryrolli</b>            1 flap door, with buffered closing            1 take-out laundry-bag, washable            4 roles            Colour version corresponds to the carcass colour            incl. height indication rolls (100 mm)</p>		470	470	756	<b>WRS 4 0 4 7</b>		
<h2>Benches</h2>  <p><b>Bench</b>            1 shelf            1 seat cushion in imitation leather            Colour version corresponds to the carcass colour            cushion in creamy-white            cushion in black</p>		450	600	508	<b>SETBANK 6 W</b> <b>SETBANK 6 S</b>		
 <p><b>Bench</b>            2 shelves            1 seat cushion in imitation leather            Colour version corresponds to the carcass colour            cushion in creamy-white            cushion in black</p>		450	900	508	<b>SETBANK 9 W</b> <b>SETBANK 9 S</b>		
<h2>Glass shelves</h2>  <p><b>Glass shelf</b>            incl. metal holder</p> <p><b>400 mm wide</b>            incl. 2 metal brackets</p> <p><b>600 mm wide</b>            incl. 2 metal brackets</p> <p><b>700 mm wide</b>            incl. 2 metal brackets</p> <p><b>900 mm wide</b>            incl. 3 metal brackets</p> <p><b>1200 mm wide</b>            incl. 3 metal brackets</p> <p><b>1400 mm wide</b>            incl. 4 metal brackets</p>		130	400	8	<b>ABG 1 3 4 0 0 8</b>		
		130	600	8	<b>ABG 1 3 6 0 0 8</b>		
		130	700	8	<b>ABG 1 3 7 0 0 8</b>		
		130	900	8	<b>ABG 1 3 9 0 0 8</b>		
		130	1200	8	<b>ABG 1 3 1 2 0 8</b>		
		130	1400	8	<b>ABG 1 3 1 4 0 8</b>		



Please observe suitable accessories in the separate index.

# Program 040 - type list

Depth indication corresponds to the carcass depth	Depth in mm	Width in mm	Height in mm	Article number	Hinge	Surcharge high-gloss carcass
<b>Push-fit shelf</b>						
 <b>Push-fit shelf</b> with ABS thick edge all around incl. holders for push fit shelf						
<b>300 mm wide</b> incl. 2 push-fit holder	150	300	28	<b>S B G 6 0 3 0</b>		
<b>400 mm wide</b> incl. 2 push-fit holder	150	400	28	<b>S B G 6 0 4 0</b>		
<b>600 mm wide</b> incl. 2 push-fit holder	150	600	28	<b>S B G 6 0 6 0</b>		
<b>700 mm wide</b> incl. 3 push-fit holder	150	700	28	<b>S B G 6 0 7 0</b>		
<b>900 mm wide</b> incl. 3 push-fit holder	150	900	28	<b>S B G 6 0 9 0</b>		
<b>1200 mm wide</b> incl. 3 push-fit holder	150	1200	28	<b>S B G 6 0 1 2</b>		
<b>1400 mm wide</b> incl. 3 push-fit holder	150	1400	28	<b>S B G 6 0 1 4</b>		
<b>Accessories</b>						
 <b>LED lighting element</b> Width 600 mm 8,53 watt / 430 lumens / (3000 -) 6500 Kelvin This product contains a light source with energy efficiency class: F	130	600	73	<b>P Z 1 0 7 7 5</b>		
 <b>LED lighting element</b> Width 900 mm 13,18 Watt / 660 lumens / (3000 -) 6500 Kelvin This product contains a light source with energy efficiency class: F	130	900	73	<b>P Z 1 0 7 8 5</b>		



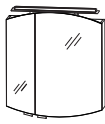

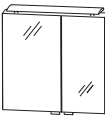
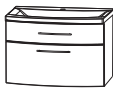
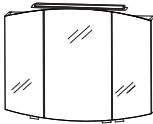
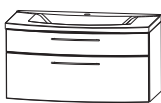
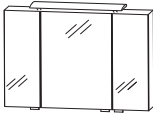
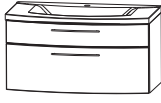

Please observe suitable accessories in the separate index.

# Programm 040 - examples

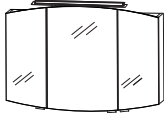
<b>CLE-2170-2</b>		 	700 mm wide	
1	Mirror cabinet, 700 mm			S 2 A 4 3 7 0 S 9
1	Washbasin base unit			W U A 3 5 7 0 7 M
1	evermite washbasin, LED, 700 mm			S W M 8 2 0 7 B 1
<b>CLE-2170-4</b>		 	700 mm wide	
1	Mirror cabinet, 700 mm			S 2 A 4 3 7 0 2 2
1	Washbasin base unit			W U A 3 5 7 0 7 M
1	evermite washbasin, LED, 700 mm			S W M 8 2 0 7 B 1
<b>CLE-2190-2</b>		 	900 mm wide	
1	Mirror cabinet, 900 mm			S 2 A 4 3 9 0 S 9
1	Washbasin base unit			W U A 3 5 9 0 7 M
1	evermite washbasin, LED, 900 mm			S W M 8 2 0 9 B 1
<b>CLE-2190-4</b>		 	900 mm wide	
1	Mirror cabinet, 900 mm			S 2 A 4 3 9 0 2 2
1	Washbasin base unit			W U A 3 5 9 0 7 M
1	evermite washbasin, LED, 900 mm			S W M 8 2 0 9 B 1

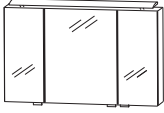
# Programm 040 - examples

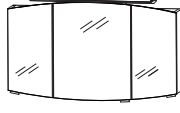
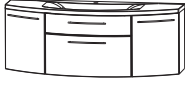
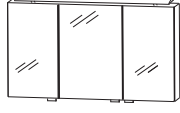
The numbers represent POINTS not prices

<b>CLE-2112-2</b>		 	1200 mm wide
1	Mirror cabinet, 1200 mm S 2 A 4 3 1 2 S 9		
1	Washbasin base unit W U A 3 5 1 2 7 M		
1	evermite washbasin, LED, 1200 mm S W M 8 2 2 0 B 1		
<b>CLE-2112-4</b>		 	1200 mm wide
1	Mirror cabinet 1200 mm S 2 A 4 3 1 2 2 2		
1	Washbasin base unit W U A 3 5 1 2 7 M		
1	evermite washbasin, LED, 1200 mm S W M 8 2 2 0 B 1		
<b>CLE-2114-2</b>		 	1400 mm wide
1	Mirror cabinet, 1400 mm S 2 A 4 3 1 4 S 9		
1	Washbasin base unit W U A 3 5 1 4 7 M		
1	evermite washbasin, LED, 1400 mm S W M 8 2 4 0 B 1		
<b>CLE-2114-4</b>		 	1400 mm wide
1	Mirror cabinet, 1400 mm S 2 A 4 3 1 4 2 2		
1	Washbasin base unit W U A 3 5 1 4 7 M		
1	evermite washbasin, LED, 1400 mm S W M 8 2 4 0 B 1		

# Programm 040 - examples

The numbers represent POINTS not prices

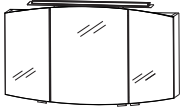
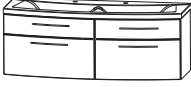
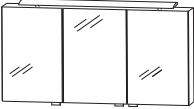
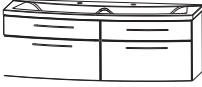
CLE-2114-2D			
1	Mirror cabinet, 1400 mm	S 2 A 4 3 1 4 S 9	
1	Washbasin base unit	W U A 3 5 1 4 6 M	
1	evermite washbasin, LED, 1400 mm Double washbasin	S W M 8 2 4 D B 1	
			
			1400 mm wide
CLE-2114-4D			
1	Mirror cabinet, 1400 mm	S 2 A 4 3 1 4 2 2	
1	Washbasin base unit	W U A 3 5 1 4 6 M	
1	evermite washbasin, LED, 1400 mm Double washbasin	S W M 8 2 4 D B 1	
			
			1400 mm wide



# Program 040 - dimensional drawings

SWM 8207

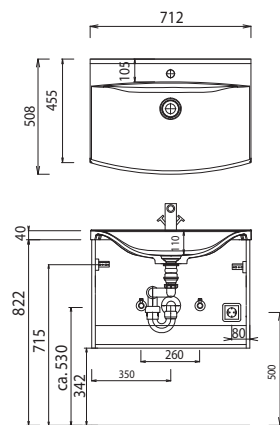

SWM 8209

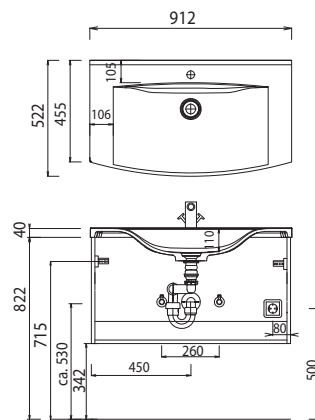

SWM 8220

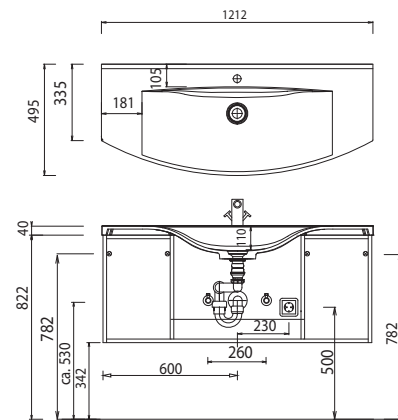

SWM 8240

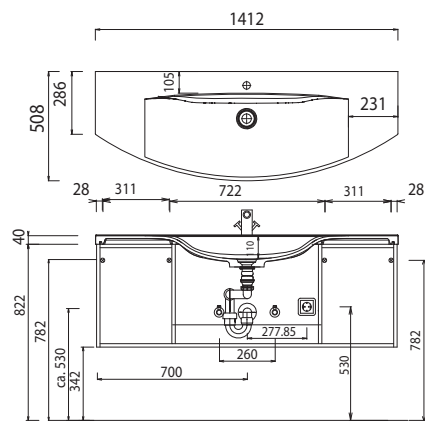

SWM 824D

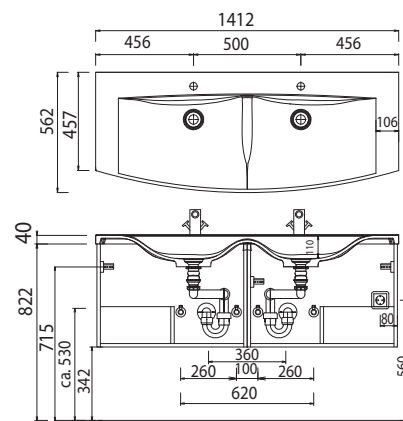

SWG 8070

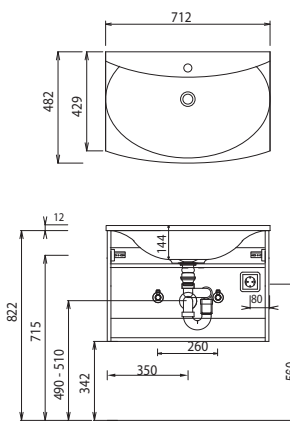

SWG 8090

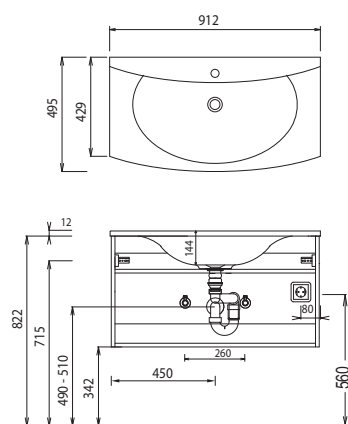

SWG 8120

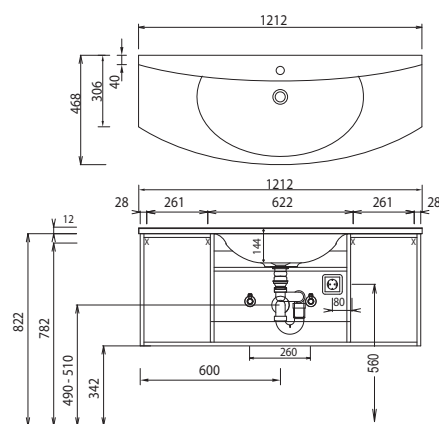

For washing stands with fixing screws, the dimensions for boring must be drawn in on-site after the washing stand has been laid on the floor unit.

**Washing stands without anchoring brackets have to be fixed on the wall and on the furniture-side with silicon!**

Cast mineral:

The water temperature must not exceed 55° C / 131° F. Hair tinting lotions have to be removed immediately, so that staining can be avoided.

Modifications:

Technical modifications (+/- 5mm) and flatness modifications (DIN 18202) are subject of the usual material-specific modifications for construction materials, based on DIN 18202.

# Program 040 - dimensional drawings

SWG 8140

electrical connections for mirror cabinets

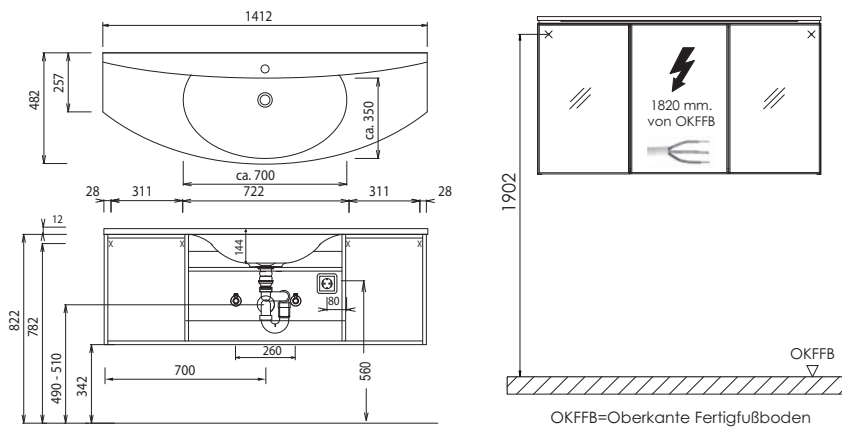

For washing stands with fixing screws, the dimensions for boring must be drawn in on-site after the washing stand has been laid on the floor unit.

**Washing stands without anchoring brackets have to be fixed on the wall and on the furniture-side with silicon!**

Cast mineral:

The water temperature must not exceed 55° C / 131° F. Hair tinting lotions have to be removed immediately, so that staining can be avoided.

Modifications:

Technical modifications (+/- 5mm) and flatness modifications (DIN 18202) are subject of the usual material-specific modifications for construction materials, based on DIN 18202.