

new
generation

PROTECTION1

Program 68



Front colours



No. 777 cosmos grey matt



No. 793 noble white matt



No. 891 quarz grey matt



No. 893 titanium grey matt



No. 686 anthracite hgl.

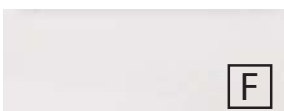

No. 722 polar white hgl.



No. 755 hacienda black



No. 769 hacienda grey



no. 670 Halifax oak

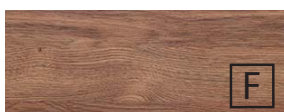

no. 680 Charleston oak



No. 750 cardiff oak



no. 751 Cuneo oak brown



no. 771 Cuneo oak natural



Nr. 785 natural oak



no. 794 sand oak

F foiled front

M Melamine coated front with ABS-edge

carcass colours

* High gloss carcass for an additional price



No. 177
cosmos grey
matt

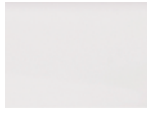

No. 111
white matt



no. 191
quarz grey matt



No. 193
titanium grey
matt



*no. 121
anthracite hgl.



*no. 161
white hgl.



no. 155
hacienda black



no. 169
hacienda grey



no. 170
Halifax oak



no. 180
Charleston oak



no. 150
cardiff oak



no. 151
Cuneo oak
brown



no. 171 Cuneo
oak natural



Nr. 185
natural oak



no. 194
sand oak

Washbasin colours

Ceramic washbasins



No. 1 white

Handle version

No. 294 bar handle chrome



handle bore 96 mm / 384 mm

Technique

door with integrated buffered closing

Pull outs and drawers

No. 559

Pull outs and drawers with soft
close



Mirror cabinets

Series A



Series B







Illustrations and specifications are without obligation. Technical modifications reserved.

2022/2023 - ID

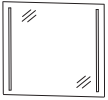
Please note the instruction for warranty, mounting and care, and the quality agreements as well, at the beginning of the book.

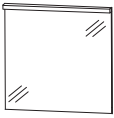
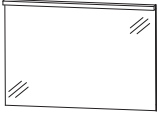

Program 068 - model list

| Depth indication corresponds to the carcass depth | | Depth in mm | Width in mm | Height in mm | Article number | | |
|---|--|----------------|----------------|-----------------|-------------------|--|--|
| Mirrors | | | | | | | |
|  | <p>Mirror LED lighting left and right 11,0 watt / Converter 15 watt 968 lumens / 6500 Kelvin incl. toggle switch This product contains a light source with energy efficiency class: F</p> | 28 | 700 | 640 | F S B 4 4 7 0 0 1 | | |
|  | <p>Mirror LED lighting left and right 11,0 watt / Converter 15 watt 968 lumens / 6500 Kelvin incl. toggle switch This product contains a light source with energy efficiency class: F</p> | 28 | 1000 | 640 | F S B 4 4 1 0 0 1 | | |
|  | <p>Mirror LED lighting left and right 11,0 watt / Converter 15 watt 968 lumens / 6500 Kelvin incl. toggle switch This product contains a light source with energy efficiency class: F</p> | 28 | 1200 | 640 | F S B 4 4 1 2 0 1 | | |
|  | <p>Mirror LED lighting vertical 6,6 Watt / converter 15 Watt 1010 lumens / 6000 Kelvin incl. toggle switch This product contains a light source with energy efficiency class: D</p> | 59 | 700 | 672 | F S A 4 3 7 0 1 2 | | |
|  | <p>Mirror LED lighting vertical 9,3 watt / converter 15 watt 1423 lumens / 6000 Kelvin incl. toggle switch This product contains a light source with energy efficiency class: D</p> | 59 | 1000 | 672 | F S A 4 3 1 0 1 2 | | |
|  | <p>Mirror LED lighting vertical 11,4 watt / converter 15 watt 1744 lumens / 6000 Kelvin incl. toggle switch This product contains a light source with energy efficiency class: D</p> | 59 | 1200 | 672 | F S A 4 3 1 2 1 2 | | |

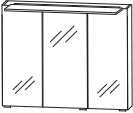
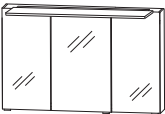
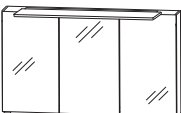
Program 068 - model list



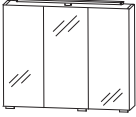
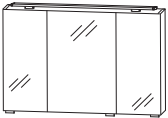
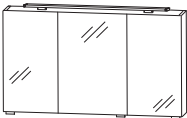

| Depth indication corresponds to the carcass depth | | Depth in mm | Width in mm | Height in mm | Article number | | | Hinge |
|---|---|----------------|----------------|-----------------|----------------|--------------------|--|-------|
| Mirror cabinets Series A | | | | | | | | |
|  incl. handle blocks | mirror cabinet 3 mirror doors on wooden-plated 2 central partitions, 3 glass shelves 1 LED surface-mounted lamp 634 mm wide 9,28 watt / Converter 15 watt 731 lumens / 6500 Kelvin 1 switch socket element Door width: 196 mm / 296 mm / 196 mm This product contains a light source with energy efficiency class: G Additional accessories LED washbasin lighting | 150 | 700 | 640 | S E T | 4 3 7 0 0 5 | | |
| | | | | | P Z | 1 0 6 3 6 0 | | |
|  incl. handle blocks | mirror cabinet 3 mirror doors on wooden-plated 2 central partitions, 3 glass shelves 1 LED surface-mounted lamp 934 mm wide 14,08 watt / converter 30watt 1109 lumens / 6500 Kelvin 1 switch socket element Door width: 288 mm / 412 mm / 288 mm This product contains a light source with energy efficiency class: G Additional accessories LED washbasin lighting | 150 | 1000 | 640 | S E T | 4 3 1 0 0 5 | | |
| | | | | | P Z | 1 0 6 3 9 0 | | |
|  incl. handle blocks | mirror cabinet 3 mirror doors on wooden-plated 2 central partitions, 3 glass shelves 3 glass shelves 1 LED surface-mounted lamp 934 mm wide 14,08 watt / converter 30watt 1109 lumens / 6500 Kelvin 1 switch socket element Door width: 388 mm / 412 mm / 388 mm This product contains a light source with energy efficiency class: G Additional accessories LED washbasin lighting | 150 | 1200 | 640 | S E T | 4 3 1 2 0 5 | | |
| | | | | | P Z | 1 0 6 3 1 2 | | |

Program 068 - model list

| | Depth in mm | Width in mm | Height in mm | Article number | Hinge |
|---|----------------|----------------|-----------------|--|-------|
| Depth indication corresponds to the carcass depth | | | | | |
| Mirror cabinet, series B | | | | | |
|  incl. handle blocks | 150 | 700 | 640 | S 2 A 4 3 7 S 1 0 P Z 1 0 6 3 60 | |
| mirror cabinet 3 mirror doors on wooden-plated 2 central partitions, 3 glass shelves 1 LED surface-mounted lamp 600 mm wide 7,8 watt / Converter 15 watt 910 lumens / 6500 Kelvin 1 switch socket element Door width: 196 mm / 296 mm / 196 mm This product contains a light source with energy efficiency class: F Additional accessories LED washbasin lighting | | | | | |
|  incl. handle blocks | 150 | 1000 | 640 | S 2 A 4 3 1 S 1 0 P Z 1 0 6 3 90 | |
| mirror cabinet 3 mirror doors on wooden-plated 2 central partitions, 3 glass shelves 1 LED surface-mounted lamp 900 mm wide 9,7 watt / Converter 15 watt 1120 lumens / 6500 Kelvin 1 switch socket element Door width: 288 mm / 412 mm / 288 mm This product contains a light source with energy efficiency class: F Additional accessories LED washbasin lighting | | | | | |
|  incl. handle blocks | 150 | 1200 | 640 | S 2 A 4 3 2 S 1 0 P Z 1 0 6 3 12 | |
| mirror cabinet 3 mirror doors on wooden-plated 2 central partitions, 3 glass shelves 1 LED surface-mounted lamp 900 mm wide 9,7 watt / Converter 15 watt 1120 lumens / 6500 Kelvin 1 switch socket element Door width: 388 mm / 412 mm / 388 mm This product contains a light source with energy efficiency class: F Additional accessories LED washbasin lighting | | | | | |
| Ceramic washbasins | | | | | |
|  Ceramic washbasin white with overflow can be combined with WUA 3770 79 | 460 | 710 | 65 | W T M 5 1 0 7 1 | |
|  Ceramic washbasin white with overflow can be combined with WUA 3710 79 | 460 | 1010 | 65 | W T M 5 1 1 0 1 | |

You find information on the the washbasin manufacturer at the beginning of the sales book.

Program 068 - model list

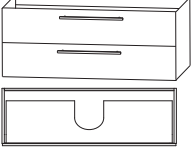
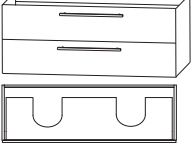
| Depth indication corresponds to the carcass depth | | Depth in mm | Width in mm | Height in mm | Article number | | Hinge |
|--|---|----------------|----------------|-----------------|--|--|-------|
| Ceramic washbasins | | | | | | | |
|  | Ceramic washbasin white with overflow can be combined with WUA 3712 79 | 460 | 1210 | 65 | WTM 5 1 1 2 1 | | |
|  | Ceramic washbasin Double washbasin white with overflow can be combined with WUA 372D 79 | 460 | 1210 | 65 | WTM 5 1 2 D 1 | | |
| Washbasin base units | | | | | | | |
|  | Washbasin base unit 1 pull-out with cushioned closure and syphon cutout 1 pull-out with buffered closing Additional accessories Space-saving drain stench trap DN 40 Space-saving drain stench trap DN 32 | 430 | 700 | 480 | WUA 3 7 7 0 7 9 P Z 1 3 6 7 P Z 1 4 2 3 | | |
|  | Washbasin base unit 1 pull-out with cushioned closure and syphon cutout 1 pull-out with buffered closing Additional accessories Space-saving drain stench trap DN 40 Space-saving drain stench trap DN 32 | 430 | 1000 | 480 | WUA 3 7 1 0 7 9 P Z 1 3 6 7 P Z 1 4 2 3 | | |
|  | Washbasin base unit for single washbasin solution 1 pull-out with cushioned closure and syphon cutout 1 pull-out with buffered closing Additional accessories Space-saving drain stench trap DN 40 Space-saving drain stench trap DN 32 | 430 | 1200 | 480 | WUA 3 7 1 2 7 9 P Z 1 3 6 7 P Z 1 4 2 3 | | |
|  | Washbasin base unit for double washbasin solutions 1 pull-out with cushioned closure and 2 syphon cutouts 1 pull-out with buffered closing Additional accessories Space-saving drain stench trap DN 40 (order 2 pieces) Space-saving drain stench trap DN 32 (order 2 pieces) | 430 | 1200 | 480 | WUA 3 7 2 D 7 9 P Z 1 3 6 7 P Z 1 4 2 3 | | |

You find information on the the washbasin manufacturer at the beginning of the sales book.

Program 068 - model list

Depth indication corresponds to the carcass depth

Tall units

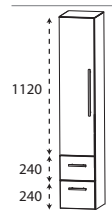
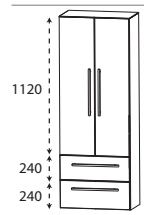
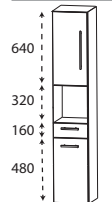
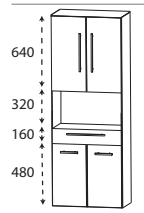
| | Depth in mm | Width in mm | Height in mm | Article number | Hinge |
|---|-------------|-------------|--------------|------------------|-------|
|  <p>Tall unit 1 door 4 glass shelves 2 pull-outs with buffered closing</p> | 300 | 300 | 1600 | HNA0830 | 4 L/R |
| | 300 | 400 | 1600 | HNA0840 | 4 L/R |
|  <p>Tall unit 2 doors 4 glass shelves 2 pull-outs with buffered closing</p> | 300 | 600 | 1600 | HNA0860 | 4 |
|  <p>Tall unit 1 door 1 glass shelf (top) 1 open compartment 1 drawer with buffered closing 1 door 1 glass shelf</p> | 300 | 300 | 1600 | HNA023001 | L/R |
| | 300 | 400 | 1600 | HNA024001 | L/R |
|  <p>Tall unit 2 doors 1 glass shelf (top) 1 open compartment 1 drawer with buffered closing 2 doors 1 glass shelf</p> | 300 | 600 | 1600 | HNA026001 | |

Program 068 - model list

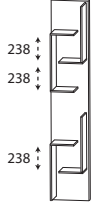
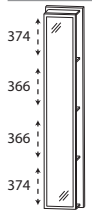
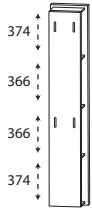
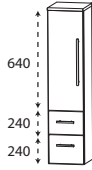
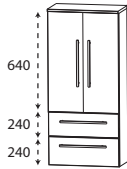

| Depth indication corresponds to the carcass depth | | Depth in mm | Width in mm | Height in mm | Article number | | Hinge |
|--|---|----------------|----------------|-----------------|----------------|--------------------|-------|
| Tall unit-shelf | | | | | | | |
|  | Tall unit-shelf with open shelf space in carcass colour | 150 | 300 | 1600 | RG | 1 0 3 0 0 1 | |
|  | Tall unit-shelf with mirror surface 4 shelves compartments in carcass colour | 150 | 300 | 1600 | RG | 1 0 3 0 0 2 | |
|  | Tall unit-shelf 4 functional hooks 4 shelves compartments in carcass colour | 150 | 300 | 1600 | RG | 1 0 3 0 0 3 | |
| Central units | | | | | | | |
|  | medium-high unit 1 door 1 glass shelf 2 pull-outs with buffered closing 1 top cover 325 mm deep | 300 | 300 | 1136 | MNA | 7 7 3 A 0 1 | L/R |
|  | medium-high unit 2 doors 1 glass shelf 2 pull-outs with buffered closing 1 top cover 325 mm deep | 300 | 600 | 1136 | MNA | 7 7 6 A 0 1 | |

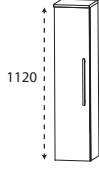
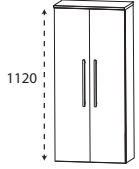
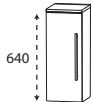
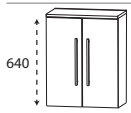
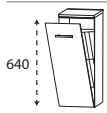
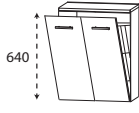
Program 068 - model list



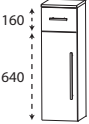
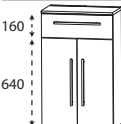
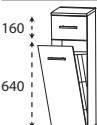

| Depth indication corresponds to the carcass depth | | Depth in mm | Width in mm | Height in mm | Article number | Hinge |
|---|---|-------------|-------------|--------------|------------------|-------|
| Central units | | | | | | |
|  | medium-high unit 1 door 3 glass shelves 1 top cover 325 mm deep | 300 | 300 | 1136 | MNA713A01 | L/R |
| | | 300 | 400 | 1136 | MNA714A01 | L/R |
|  | medium-high unit 2 doors 2 glass shelves 1 top cover 325 mm deep | 300 | 600 | 1136 | MNA716A01 | |
| Highboards | | | | | | |
|  | Highboard 1 door 1 glass shelf 1 top cover 325 mm deep | 300 | 300 | 656 | HBA413A01 | L/R |
| | | 300 | 400 | 656 | HBA414A01 | L/R |
|  | Highboard 2 doors 1 glass shelf 1 top cover 325 mm deep | 300 | 600 | 656 | HBA416A01 | |
|  | Highboard with laundry basket 1 laundry basket with wire basket 1 top cover 325 mm deep Volume of laundry basket: 25 liters | 300 | 300 | 656 | HBA413W01 | |
| | Volume of laundry basket: 35 liters | 300 | 400 | 656 | HBA414W01 | |
|  | Highboard with laundry basket 1 laundry basket with wire basket 1 top cover 325 mm deep Volume of laundry basket: 55 liters | 300 | 600 | 656 | HBA416W01 | |

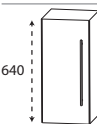
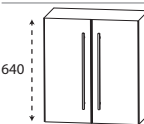
Program 068 - model list

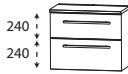

Depth indication corresponds to the carcass depth

| | Depth in mm | Width in mm | Height in mm | Article number | Hinge |
|---|----------------|----------------|-----------------|--------------------------|-------|
| Highboards | | | | | |
|  <p>160 640</p> | | | 816 | H B A 5 5 3 A 0 1 | L/R |
| | | | 816 | H B A 5 5 4 A 0 1 | L/R |
|  <p>160 640</p> | 300 | 600 | 816 | H B A 5 5 6 A 0 1 | |
|  <p>160 640</p> | | | 816 | H B A 5 5 3 W 0 1 | |
| | | | 816 | H B A 5 5 4 W 0 1 | |
|  <p>160 640</p> | 300 | 600 | 816 | H B A 5 5 6 W 0 1 | |
| Wall units | | | | | |
|  <p>640</p> | 150 | 300 | 640 | O G A 4 1 3 0 | L/R |
| | 150 | 400 | 640 | O G A 4 1 4 0 | L/R |
|  <p>640</p> | 150 | 600 | 640 | O G A 4 1 6 0 | |

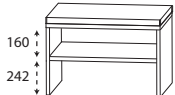



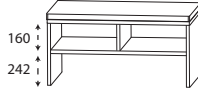



Program 068 - model list

| Depth indication corresponds to the carcass depth | | Depth in mm | Width in mm | Height in mm | Article number | Hinge |
|---|---|-------------|-------------|--------------|--------------------------|-------|
| Base units | | | | | | |
|  | Base unit 2 pull-outs with buffered closing 1 top cover 325 mm deep | 300 | 300 | 496 | U N A 3 6 3 A 0 1 | |
| | | 300 | 400 | 496 | U N A 3 6 4 A 0 1 | |
|  | Base unit 2 pull-outs with buffered closing 1 top cover 325 mm deep | 300 | 600 | 496 | U N A 3 6 6 A 0 1 | |
| Shelves | | | | | | |
|  | functional shelf Edges are cut with a mitre vertical and horizontal mounting possible please indicate colour version: no. 501 white matt lacquered no. 547 black matt lacquered | 150 | 300 | 160 | R G L 1 1 3 0 0 1 | |
|  | functional shelf Edges are cut with a mitre vertical and horizontal mounting possible please indicate colour version: no. 501 white matt lacquered no. 547 black matt lacquered | 150 | 600 | 160 | R G L 1 1 6 0 0 2 | |
|  | functional shelf Edges are cut with a mitre vertical and horizontal mounting possible please indicate colour version: no. 501 white matt lacquered no. 547 black matt lacquered | 150 | 900 | 160 | R G L 1 1 9 0 0 3 | |
| Benches | | | | | | |
|  | Bench 1 shelf 1 seat cushion in imitation leather Colour version corresponds to the carcass colour cushion in creamy-white cushion in black | 450 | 600 | 508 | S E T B A N K 6 W | |
| | | 450 | 600 | 508 | S E T B A N K 6 S | |







Program 068 - model list

| Depth indication corresponds to the carcass depth | Depth in mm | Width in mm | Height in mm | Article number | Hinge |
|--|--|-------------|--------------|------------------|-------|
| Benches | | | | | |
|  | Bench 2 shelves 1 seat cushion in imitation leather Colour version corresponds to the carcass colour | | | | |
| cushion in creamy-white | 450 | 900 | 508 | SETBANK9W | |
| cushion in black | 450 | 900 | 508 | SETBANK9S | |
| Glass shelves | | | | | |
|  | Glass shelf incl. metal holder | | | | |
| 400 mm wide incl. 2 metal brackets | 130 | 400 | 8 | ABG134008 | |
| 600 mm wide incl. 2 metal brackets | 130 | 600 | 8 | ABG136008 | |
| 700 mm wide incl. 2 metal brackets | 130 | 700 | 8 | ABG137008 | |
| 1000 mm wide incl. 3 metal brackets | 130 | 1000 | 8 | ABG131008 | |
| 1200 mm wide incl. 3 metal brackets | 130 | 1200 | 8 | ABG131208 | |
| Push-fit shelf | | | | | |
|  | Push-fit shelf with ABS thick edge all around incl. holders for push fit shelf | | | | |
| 300 mm wide incl. 2 push-fit holder | 150 | 300 | 28 | SBG6030 | |
| 400 mm wide incl. 2 push-fit holder | 150 | 400 | 28 | SBG6040 | |
| 600 mm wide incl. 2 push-fit holder | 150 | 600 | 28 | SBG6060 | |
| 700 mm wide incl. 3 push-fit holder | 150 | 700 | 28 | SBG6070 | |
| 1000 mm wide incl. 3 push-fit holder | 150 | 1000 | 28 | SBG6010 | |
| 1200 mm wide incl. 3 push-fit holder | 150 | 1200 | 28 | SBG6012 | |

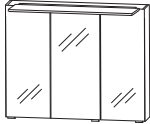
Program 068 - model list

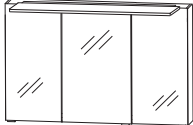
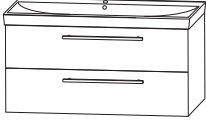
| Depth indication corresponds to the carcass depth | | Depth in mm | Width in mm | Height in mm | Article number | | | Hinge |
|---|--|----------------|----------------|-----------------|----------------|-------------|--|-------|
| Accessories | | | | | | | | |
|  | Towel holder chrome gloss front opened to fit on carcass at side Please observe carcass depth and furniture height | 380 | 50 | 10 | P Z | 1 1 2 7 4 5 | | |
|  | Towel holder one-armed extendable Chrome hgl. wall-mounted | 330-567 | 44 | 44 | P Z | 1 1 3 7 1 | | |
|  | Towel holder two-armed extendable Chrome hgl. wall-mounted | 322-562 | 87 | 47 | P Z | 1 1 3 7 2 | | |
|  | LED washbasin lighting 2,4 Watt / 168 lumens / 6500 Kelvin 1 switch element to fit underneath mirror cabinet This product contains a light source with energy efficiency class: G not suitable with Emotion lighting | 10 | 560 | 10 | P Z | 1 0 6 3 6 0 | | |
|  | LED washbasin lighting 3,9 Watt / 287 lumens / 6500 Kelvin 1 switch element to fit underneath mirror cabinet This product contains a light source with energy efficiency class: G not suitable with Emotion lighting | 10 | 860 | 10 | P Z | 1 0 6 3 9 0 | | |
|  | LED washbasin lighting 5,3 Watt / 371 lumens / 6500 Kelvin 1 switch element to fit underneath mirror cabinet This product contains a light source with energy efficiency class: G not suitable with Emotion lighting | 10 | 1160 | 10 | P Z | 1 0 6 3 1 2 | | |
|  | Touch LED Dimmer for LED mirror cabinets and lightings | | | | P Z | 1 0 5 7 | | |
|  | Space-saving drain stench trap from GEBERIT made of plastic, in white nominal diameter: 40 | | | | P Z | 1 3 6 7 | | |
|  | Space-saving drain stench trap from GEBERIT made of plastic, in white nominal diameter: 32 | | | | P Z | 1 4 2 3 | | |

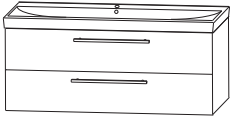
Program 068 - bathroom variations

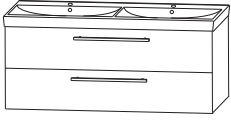
| | | | | |
|--------------------|---|-------------------|--|--|
| P1K-0170-1 | | | | |
| 1 | mirror cabinet Series A | S E T 4 3 7 0 0 5 | |   710 mm wide |
| 1 | ceramic washbasins, white, 710 mm | W T M 5 1 0 7 1 | | |
| 1 | Washbasin base unit | W U A 3 7 7 0 7 9 | | |
| P1K-0110-1 | | | | |
| 1 | mirror cabinet Series A | S E T 4 3 1 0 0 5 | |   1010 mm wide |
| 1 | ceramic washbasins, white, 1010 mm | W T M 5 1 1 0 1 | | |
| 1 | Washbasin base unit | W U A 3 7 1 0 7 9 | | |
| P1K-0112-1 | | | | |
| 1 | mirror cabinet Series A | S E T 4 3 1 2 0 5 | |   1210 mm wide |
| 1 | ceramic washbasins, white, 1210 mm | W T M 5 1 1 2 1 | | |
| 1 | Washbasin base unit | W U A 3 7 1 2 7 9 | | |
| P1K-0112-D1 | | | | |
| 1 | mirror cabinet Series A | S E T 4 3 1 2 0 5 | |   1210 mm wide |
| 1 | double ceramic washbasins, white, 1210 mm | W T M 5 1 2 D 1 | | |
| 1 | Washbasin base unit | W U A 3 7 2 D 7 9 | | |

Program 068 - dimensional drawings

WTM 5107 1

WTM 5110 1

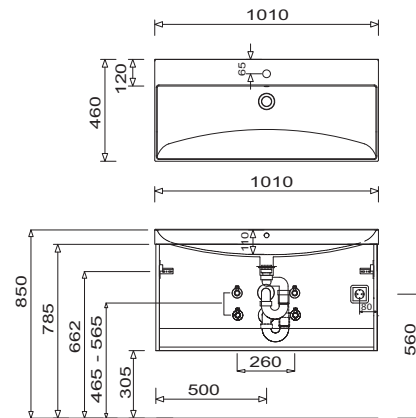
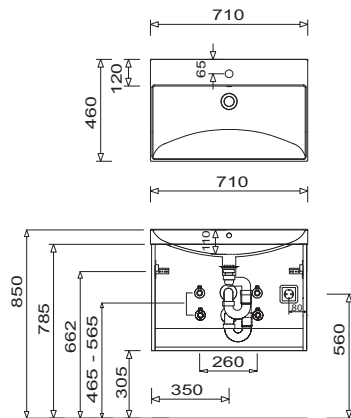

WTM 5112 1

WTM 512D 1

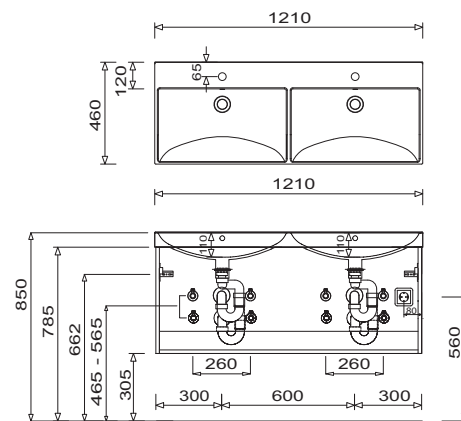
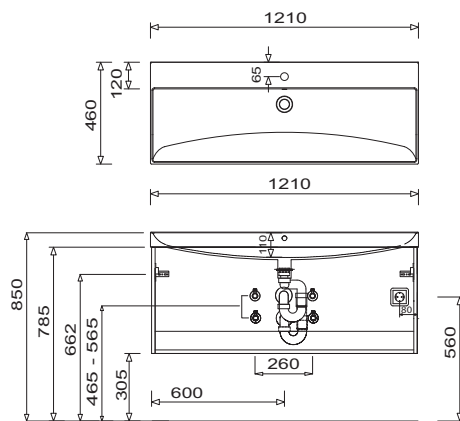

electrical connections for mirror cabinets

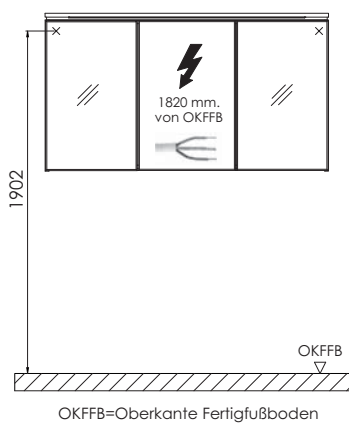

Washing stands without anchoring brackets have to be fixed on the wall and on the furniture-side with silicon!

Modifications:

Technical modifications (+/- 5mm) and flatness modifications (DIN 18202) are subject of the usual material-specific modifications for construction materials, based on DIN 18202.