



Front colours



No. 777 cosmos grey matt



No. 793 noble white matt



No. 891 quarz grey matt



No. 893 titanium grey matt



No. 686 anthracite hgl.



No. 722 polar white hgl.



no. 680 Charleston oak



Nr. 785 natural oak

F foiled front

carcass colours

* High gloss carcass for an additional price



No. 111
white matt



No. 177
cosmos grey matt



no. 191
quartz grey matt



No. 193
titanium grey
matt



*no. 121
anthracite hgl.



*no. 161
white hgl.



no. 180
Charleston oak



Nr. 185
natural oak

Handle versions



No. 320 bar handle chrome

handle-borehole distance for straight
fronts: 96 mm / 384 mm



No. 350 bar handle black

handle-borehole distance for straight
fronts: 96 mm / 384 mm

Washbasin colours

Cast mineral washbasins

Ceramic washbasins



no. 1
white



no. 1
white

Technique

Pull outs and drawers

No. 554

door with integrated buffered closing

Mirror cabinets

Series 1



Series 2



Series 3



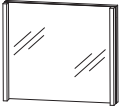
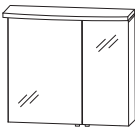
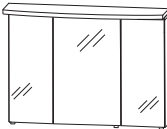

Program 038 - model list

Depth indication corresponds to the carcass depth		Depth in mm	Width in mm	Height in mm	Article number	Hinge
Mirrors						
	<p>Mirror 2 vertical LED lighting elements 2 x 6 watt / converter 30 watt 2 x 462 lumens / 6000 Kelvin incl. toggle switch This product contains a light source with energy efficiency class: G</p> <p>600 mm wide</p> <p>800 mm wide</p> <p>1000 mm wide</p> <p>1200 mm wide</p>	43	600	640	F S A 4 3 6 0 1 0	
		43	800	640	F S A 4 3 8 0 1 0	
		43	1000	640	F S A 4 3 1 0 1 0	
		43	1200	640	F S A 4 3 1 2 1 0	
Mirror cabinets Series 1						
	<p>Mirror cabinet Gesims (300 mm tief) 1 LED-built-in light 4,0 watt / converter 15 watt 295 lumens / 6500 Kelvin 1 middle panel 2 mirror doors on wooden-plated 2 glass shelves 1 switch socket element Door width: 396 mm / 196 mm This product contains a light source with energy efficiency class: G</p> <p>Additional accessories LED washbasin lighting</p>	150	600	680	S 2 A 4 3 6 0 5 5	
incl. handle blocks Door hinge exchangeable					P Z 1 0 6 3 6 0	
	<p>Mirror cabinet Gesims (300 mm tief) 1 LED-built-in light 4,0 watt / converter 15 watt 295 lumens / 6500 Kelvin 1 middle panel 3 mirror doors on wooden-plated 2 central partitions, 6 glass shelves 1 switch socket element Door width: 238 mm / 312 mm / 238 mm This product contains a light source with energy efficiency class: G</p> <p>Additional accessories LED washbasin lighting</p>	150	800	680	S 2 A 4 3 8 0 5 5	
incl. handle blocks					P Z 1 0 6 3 6 0	

Please observe suitable accessories in the separate index.

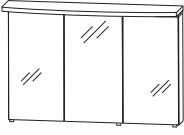
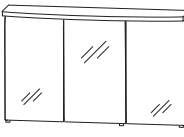
Program 038 - model list

Depth indication corresponds to the carcass depth		Depth in mm	Width in mm	Height in mm	Article number			Hinge							
Mirror cabinets Series 1															
	<p>Mirror cabinet Gesims (300 mm tief) 1 LED-built-in light 4,0 watt / converter 15 watt 295 lumens / 6500 Kelvin 1 middle panel 3 mirror doors on wooden-plated 2 central partitions, 6 glass shelves 1 switch socket element Door width: 288 mm / 412 mm / 288 mm This product contains a light source with energy efficiency class: G</p> <p>incl. handle blocks</p> <p>Additional accessories LED washbasin lighting</p>	150	1000	680	S	2	A	4	3	1	0	5	5		
	<p>Mirror cabinet Gesims (300 mm tief) 1 LED-built-in light 4,0 watt / converter 15 watt 295 lumens / 6500 Kelvin 1 middle panel 3 mirror doors on wooden-plated 2 central partitions, 6 glass shelves 1 switch socket element Door width: 388 mm / 412 mm / 388 mm This product contains a light source with energy efficiency class: G</p> <p>incl. handle blocks</p> <p>Additional accessories LED washbasin lighting</p>	150	1200	680	S	2	A	4	3	1	2	5	5		
Mirror cabinets Series 2															
	<p>Mirror cabinet 1 LED panel light 8,18 watt / Converter 15 watt 818 lumens / 6500 Kelvin 2 mirror doors on wooden-plated 2 glass shelves 1 switch socket element Door width: 396 mm / 196 mm This product contains a light source with energy efficiency class: F</p> <p>incl. handle blocks Door hinge exchangeable</p> <p>Additional accessories LED washbasin lighting</p>	150	600	649	S	2	A	4	3	6	0	8	1		

Please observe suitable accessories in the separate index.

Program 038 - model list

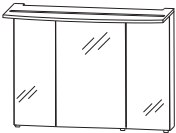
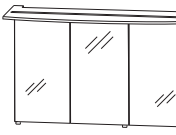
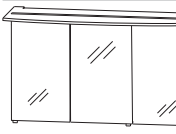
Depth indication corresponds to the carcass depth		Depth in mm	Width in mm	Height in mm	Article number	Hinge
Mirror cabinets Series 2						
 <p>incl. handle blocks</p>	<p>Mirror cabinet 1 LED panel light 15,0 watt / converter 30 watt 1500 lumens / 6500 Kelvin 3 mirror doors on wooden-plated 2 central partitions, 6 glass shelves 1 switch socket element Door width: 238 mm / 312 mm / 238 mm This product contains a light source with energy efficiency class: F</p> <p>Additional accessories LED washbasin lighting</p>	150	800	649	S 2 A 4 3 8 0 8 1	
 <p>incl. handle blocks</p>	<p>Mirror cabinet 1 LED panel light 14,4 Watt / converter 30 Watt 1680 lumens / 6500 Kelvin 3 mirror doors on wooden-plated 2 central partitions, 6 glass shelves 1 switch socket element Door width: 288 mm / 412 mm / 288 mm This product contains a light source with energy efficiency class: F</p> <p>Additional accessories LED washbasin lighting</p>	150	1000	649	S 2 A 4 3 1 0 8 1	
 <p>incl. handle blocks</p>	<p>Mirror cabinet 1 LED panel light 17,28 watt / converter 30 watt 2220 lumens / 6500 Kelvin 3 mirror doors on wooden-plated 2 central partitions, 6 glass shelves 1 switch socket element Door width: 388 mm / 412 mm / 388 mm This product contains a light source with energy efficiency class: F</p> <p>Additional accessories LED washbasin lighting</p>	150	1200	649	S 2 A 4 3 1 2 8 1	





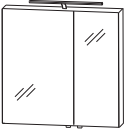
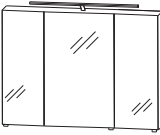
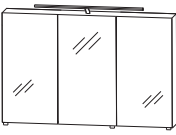
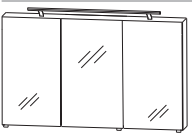

Please observe suitable accessories in the separate index.

Program 038 - model list

Depth indication corresponds to the carcass depth		Depth in mm	Width in mm	Height in mm	Article number	Hinge
 <p>mirror cabinet 2 mirror doors on wooden-plated 2 glass shelves 1 LED surface-mounted lamp 400 mm 6,5 Watt / converter 15 Watt 760 lumens / 6500 Kelvin 1 switch socket element Door width: 396 mm / 196 mm This product contains a light source with energy efficiency class: F</p> <p>incl. handle blocks Door hinge exchangeable</p> <p>Additional accessories LED washbasin lighting</p>		150	600	640	S 2 A 4 3 6 0 A 1	
 <p>mirror cabinet 3 mirror doors on wooden-plated 2 central partitions, 6 glass shelves 1 LED surface-mounted lamp 600 mm 9,7 watt / Converter 15 watt 1140 lumens / 6500 Kelvin 1 switch socket element Door width: 238 mm / 312 mm / 238 mm This product contains a light source with energy efficiency class: F</p> <p>incl. handle blocks</p> <p>Additional accessories LED washbasin lighting</p>		150	800	640	S 2 A 4 3 8 0 A 1	
 <p>mirror cabinet 3 mirror doors on wooden-plated 2 central partitions, 6 glass shelves 1 LED surface-mounted lamp 600 mm 9,7 watt / Converter 15 watt 1140 lumens / 6500 Kelvin 1 switch socket element Door width: 288 mm / 412 mm / 288 mm This product contains a light source with energy efficiency class: F</p> <p>incl. handle blocks</p> <p>Additional accessories LED washbasin lighting</p>		150	1000	640	S 2 A 4 3 1 0 A 1	
 <p>mirror cabinet 3 mirror doors on wooden-plated 2 central partitions, 6 glass shelves 1 LED surface-mounted lamp 900 mm 13,6 Watt / converter 30 Watt 1580 lumens / 6500 Kelvin 1 switch socket element Door width: 388 mm / 412 mm / 388 mm This product contains a light source with energy efficiency class: F</p> <p>incl. handle blocks</p> <p>Additional accessories LED washbasin lighting</p>		150	1200	640	S 2 A 4 3 1 2 A 1	





You find information on the the washbasin manufacturer at the beginning of the sales book.
Please observe suitable accessories in the separate index.

Program 038 - model list

Depth indication corresponds to the carcass depth		Depth in mm	Width in mm	Height in mm	Article number			Hinge
Cast mineral washbasins								
	Cast mineral washbasin colour white	486	606	28	WMM 8 5 0 6	1		
	Cast mineral washbasin colour white	520	806	28	WMM 8 5 0 8	1		
	Cast mineral washbasin colour white	520	1006	28	WMM 8 5 1 0	1		
	Cast mineral washbasin colour white	520	1206	28	WMM 8 5 2 0	1		
Ceramic washbasins								
	Ceramic washbasin colour white							
	without LED lighting	511	620	28	WTM 8 5 0 6	1		
	with LED lighting 1 LED converter 12 V, 15 Watt 259 lumens / 6500 Kelvin incl. toggle switch This product contains a light source with energy efficiency class: F	511	620	28	WTM 8 5 0 6 B	1		
	Additional accessories motion sensor for LED lighting				P Z	1 1 4 1		
	Ceramic washbasin colour white							
	without LED lighting	547	820	28	WTM 8 5 0 8	1		
	with LED lighting 1 LED converter 12 V, 15 Watt 342 lumens / 6500 Kelvin incl. toggle switch This product contains a light source with energy efficiency class: F	547	820	28	WTM 8 5 0 8 B	1		
	Additional accessories motion sensor for LED lighting				P Z	1 1 4 1		

You find information on the the washbasin manufacturer at the beginning of the sales book.
Please observe suitable accessories in the separate index.

Program 038 - model list

	Depth in mm	Width in mm	Height in mm	Article number	Hinge
Depth indication corresponds to the carcass depth					
Ceramic washbasins					
 <p>Ceramic washbasin colour white</p> <p>without LED lighting</p> <p>with LED lighting 1 LED converter 12 V, 15 Watt 432 lumens / 6500 Kelvin incl. toggle switch This product contains a light source with energy efficiency class: F</p> <p>Additional accessories motion sensor for LED lighting</p>	547	1020	28	WTM 8 5 1 0 1	
	547	1020	28	WTM 8 5 1 0 B 1	
 <p>Ceramic washbasin colour white</p> <p>without LED lighting</p> <p>with LED lighting 1 LED converter 12 V, 15 Watt 522 lumens / 6500 Kelvin incl. toggle switch This product contains a light source with energy efficiency class: F</p> <p>Additional accessories motion sensor for LED lighting</p>	547	1220	28	WTM 8 5 2 0 1	
	547	1220	28	WTM 8 5 2 0 B 1	
Washbasin base units					
 <p>Washbasin base unit 1 metal pull out unit with buffered closing 1 metal pull out unit with buffered closing and rail</p> <p>sidewise carcass depth = 415 mm</p> <p>Additional accessories Space-saving drain stretch trap DN 40 Space-saving drain stretch trap DN 32</p>	469	600	480	WUA 3 5 6 0 1 4	
				PZ 1 3 6 7 PZ 1 4 2 3	
 <p>Washbasin base unit 1 metal pull out unit with buffered closing 1 metal pull out unit with buffered closing and rail</p> <p>sidewise carcass depth = 430 mm</p> <p>Additional accessories Space-saving drain stretch trap DN 40 Space-saving drain stretch trap DN 32</p>	506	800	480	WUA 3 5 8 0 1 4	
				PZ 1 3 6 7 PZ 1 4 2 3	

You find information on the the washbasin manufacturer at the beginning of the sales book.
Please observe suitable accessories in the separate index.

Program 038 - model list

The numbers represent POINTS not prices

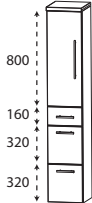
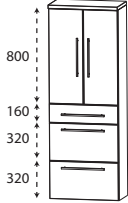
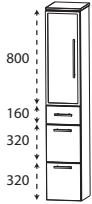
Depth indication corresponds to the carcass depth		Depth in mm	Width in mm	Height in mm	Article number	Hinge	Surcharge high-gloss carcass
Washbasin base units							
	Washbasin base unit 1 metal pull out unit with buffered closing 1 metal pull out unit with buffered closing and rail sidewise carcass depth = 400 mm Additional accessories Space-saving drain stench trap DN 40 Space-saving drain stench trap DN 32	506	1000	480	W U A 3 5 1 0 1 4 P Z 1 3 6 7 P Z 1 4 2 3		305 10 7 10
	Washbasin base unit 1 metal pull out unit with buffered closing 1 metal pull out unit with buffered closing and rail sidewise carcass depth = 370 mm Additional accessories Space-saving drain stench trap DN 40 Space-saving drain stench trap DN 32	506	1200	480	W U A 3 5 1 2 1 4 P Z 1 3 6 7 P Z 1 4 2 3		325 10 7 10
Tall units							
	Tall unit 1 door 2 glass shelves (top) 1 drawer with buffered closing 2 metal pull-outs with buffered closing 1 top cover 325 mm deep	300	300	1616	H N A 0 9 3 A	L/R	211 19
	Tall unit 2 glass shelves (top) 1 drawer with buffered closing 2 metal pull-outs with buffered closing 1 top cover 325 mm deep	300	400	1616	H N A 0 9 4 A	L/R	231 20
	Tall unit 2 doors 2 glass shelves (top) 1 drawer with buffered closing 2 metal pull-outs with buffered closing 1 top cover 325 mm deep	300	600	1616	H N A 0 9 6 A		305 21
	Tall unit 1 aluminium framed door with satined glass 2 glass shelves (top) 2 metal pull-outs with buffered closing 1 drawer with buffered closing 1 top cover 325 mm deep	300	300	1616	H N A 0 9 3 B	L/R	247 19

Please observe suitable accessories in the separate index.

Program 038 - model list

The numbers represent POINTS not prices

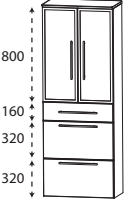
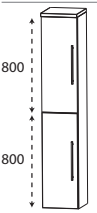
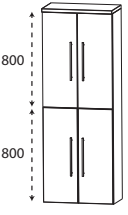
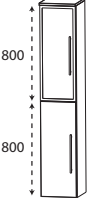
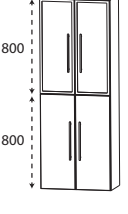
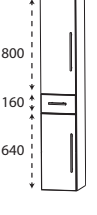
Depth indication corresponds to the carcass depth		Depth in mm	Width in mm	Height in mm	Article number	Hinge	Surcharge high-gloss carcass	
Tall units								
	<p>Tall unit 2 aluminium framed doors with satined glass 2 glass shelves (top) 1 drawer with buffered closing 2 metal pull-outs with buffered closing 1 top cover 325 mm deep</p>	300	600	1616	H N A 0 9 6 B		377	21
	<p>Tall unit 2 doors 2 glass shelves (top) 2 adjustable shelves (bottom) 1 top cover 325 mm deep</p>	300	300	1616	H N A 0 3 3 A	L/R	140	19
	<p>Tall unit 4 doors 2 glass shelves (top) 2 adjustable shelves (bottom) 1 top cover 325 mm deep</p>	300	600	1616	H N A 0 3 6 A		226	21
	<p>Tall unit 1 aluminium framed door 1 door 2 glass shelves (top) 2 adjustable shelves (bottom) 1 top cover 325 mm deep</p>	300	300	1616	H N A 0 3 3 B	L/R	176	19
	<p>Tall unit 2 aluminium framed doors 2 doors 2 glass shelves (top) 2 adjustable shelves (bottom) 1 top cover 325 mm deep</p>	300	600	1616	H N A 0 3 6 B		298	21
	<p>Tall unit 1 door 2 glass shelves (top) 1 drawer with buffered closing 1 door 1 glass shelf 1 top cover 325 mm deep</p>	300	300	1616	H N A 0 5 3 A	L/R	166	19
		300	400	1616	H N A 0 5 4 A	L/R	183	20

Please observe suitable accessories in the separate index.

Program 038 - model list

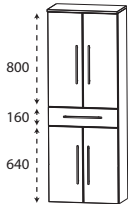
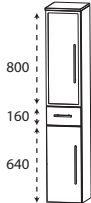
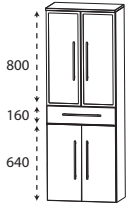
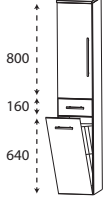
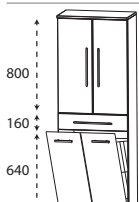
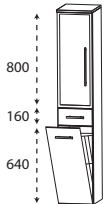

The numbers represent POINTS not prices

Depth indication corresponds to the carcass depth		Depth in mm	Width in mm	Height in mm	Article number	Hinge	Surcharge high-gloss carcass
Tall units							
	<p>Tall unit 2 doors 2 glass shelves (top) 1 metal drawer with buffered closing 2 doors 1 glass shelf 1 top cover 325 mm deep</p>	300	600	1616	H N A 0 5 6 A		247 21
	<p>Tall unit 1 aluminium framed door with satined glass 2 glass shelves (top) 1 metal drawer 1 door 1 glass shelf 1 top cover 325 mm deep</p>	300	300	1616	H N A 0 5 3 B	L/R	202 19
	<p>Tall unit 2 aluminium framed doors with satined glass 2 glass shelves (top) 1 metal drawer 2 doors 1 glass shelf 1 top cover 325 mm deep</p>	300	600	1616	H N A 0 5 6 B		319 21
	<p>Tall unit with laundry basket 1 door 2 glass shelves 1 drawer with buffered closing 1 laundry basket with wire basket 1 top cover 325 mm deep</p> <p>Volume of laundry basket: 25 liters Volume of laundry basket: 35 liters</p>	300	300	1616	H N A 0 5 3 A	W L/R	180 19
		300	400	1616	H N A 0 5 4 A	W L/R	198 20
	<p>Tall unit with laundry basket 2 doors 2 glass shelves (top) 1 drawer with buffered closing 1 laundry basket with wire basket 1 top cover 325 mm deep</p> <p>Volume of laundry basket: 55 liters</p>	300	600	1616	H N A 0 5 6 A	W	270 21
	<p>Tall unit with laundry basket 1 aluminium framed door with satined glass 2 glass shelves (top) 1 drawer with buffered closing 1 laundry basket with wire basket 1 top cover 325 mm deep</p> <p>Volume of laundry basket: 25 liters</p>	300	300	1616	H N A 0 5 3 B	W L/R	216 19

Please observe suitable accessories in the separate index.

Program 038 - model list

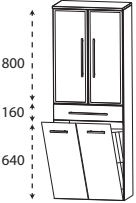
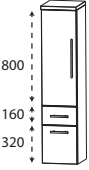
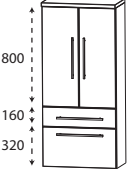
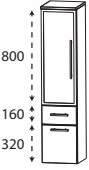
The numbers represent POINTS not prices

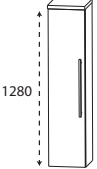
	Depth in mm	Width in mm	Height in mm	Article number	Hinge	Surchar- ge high- gloss carcass
Depth indication corresponds to the carcass depth						
Tall units						
 <p>Tall unit with laundry basket 2 aluminium framed doors with satined glass 2 glass shelves (top) 1 drawer with buffered closing 1 laundry basket with wire basket 1 top cover 325 mm deep Volume of laundry basket: 55 liters</p>	300	600	1616	H N A 0 5 6 B W		342 21
Central units						
 <p>medium-high unit 1 door 2 glass shelves (top) 1 metal pull-out with buffered closing, 1 drawer with buffered closing 1 top cover 325 mm deep</p>	300 300	300 400	1296 1296	M N A 8 8 3 A M N A 8 8 4 A	L/R L/R	170 17 186 18
 <p>medium-high unit 2 doors 2 glass shelves (top) 1 metal pull-out with buffered closing, 1 drawer with buffered closing 1 top cover 325 mm deep</p>	300	600	1296	M N A 8 8 6 A		248 18
 <p>medium-high unit 1 aluminium framed door with satined glass 2 glass shelves (top) 1 metal pull-out with buffered closing 1 drawer with buffered closing 1 top cover 325 mm deep</p>	300	300	1296	M N A 8 8 3 B	L/R	206 17
 <p>medium-high unit 2 aluminium framed doors with satined glass 2 glass shelves (top) 1 metal pull- out 1 metal drawer 1 top cover 325 mm deep</p>	300	600	1296	M N A 8 8 6 B		320 18
 <p>medium-high unit 1 door 4 glass shelves 1 top cover 325 mm deep</p>	300 300	300 400	1296 1296	M N A 8 1 3 A M N A 8 1 4 A	L/R L/R	111 17 123 18

Please observe suitable accessories in the separate index.

Program 038 - model list



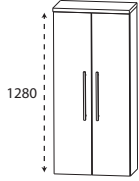
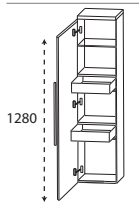
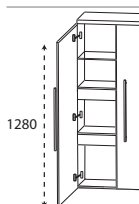
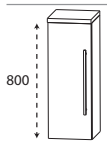
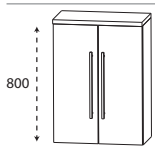
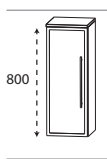
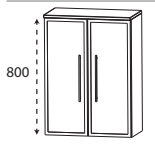

The numbers represent POINTS not prices

Depth indication corresponds to the carcass depth		Depth in mm	Width in mm	Height in mm	Article number	Hinge	Surcharge high-gloss carcass
Central units							
	medium-high unit 2 doors 4 glass shelves 1 top cover 325 mm deep	300	600	1296	M N A 8 1 6 A		173 18
	medium-high unit with inside drawers 1 door 2 inside metal- drawers with buffered closing 1 glass shelf 1 top cover 325 mm deep	300	300	1296	M N A 8 4 3 A	L/R	161 17
		300	400	1296	M N A 8 4 4 A	L/R	177 18
	medium-high unit with inside drawers 2 doors 1 continuous glass shelf 2 continuously inside metal-drawer with buffered closing 1 top cover 325 mm deep	300	600	1296	M N A 8 4 6 A		235 18
Highboards							
	Highboard 1 door 2 glass shelves 1 top cover 325 mm deep	300	300	816	H B A 5 1 3 A	L/R	78 12
		300	400	816	H B A 5 1 4 A	L/R	89 13
	Highboard 2 doors 2 glass shelves 1 top cover 325 mm deep	300	600	816	H B A 5 1 6 A		124 13
	Highboard 1 aluminium framed door 2 glass shelves 1 top cover 325 mm deep	300	300	816	H B A 5 1 3 B	L/R	114 12
	Highboard 2 aluminium framed doors 2 glass shelves 1 top cover 325 mm deep	300	600	816	H B A 5 1 6 B		196 13

Please observe suitable accessories in the separate index.

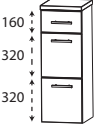
Program 038 - model list

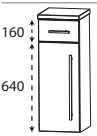
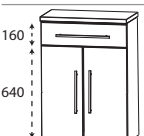
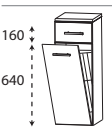

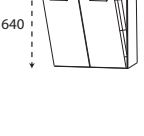
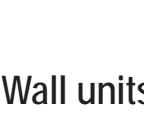
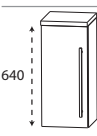

The numbers represent POINTS not prices

Depth indication corresponds to the carcass depth		Depth in mm	Width in mm	Height in mm	Article number		Hinge	Surcharge high-gloss carcass		
		Highboard		300	300	816	H B A 5 6 3 A		170	12
		1 drawer with buffered closing		300	400	816	H B A 5 6 4 A		185	13
		Highboard		300	600	816	H B A 5 6 6 A		224	13
		1 drawer with buffered closing								
		Highboard		300	300	816	H B A 5 5 3 A	L/R	109	12
		1 drawer with buffered closing		300	400	816	H B A 5 5 4 A	L/R	123	13
		Highboard		300	600	816	H B A 5 5 6 A		153	13
		1 drawer with buffered closing								
		Highboard with laundry basket								
		1 drawer with buffered closing								
		1 laundry basket with wire basket		300	300	816	H B A 5 5 3 A	W	123	12
		1 top cover 325 mm deep		300	400	816	H B A 5 5 4 A	W	138	13
		Highboard with laundry basket								
		1 drawer with buffered closing								
		1 laundry basket with wire basket								
		1 top cover 325 mm deep		300	600	816	H B A 5 5 6 A	W	176	13
		Wall unit		150	300	656	O G A 4 1 3 A	L/R	55	10
		1 door		150	400	656	O G A 4 1 4 A	L/R	65	11
1 glass shelf										
1 top cover 175 mm										

Please observe suitable accessories in the separate index.

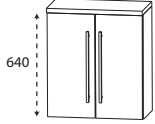
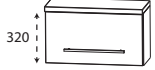
Program 038 - model list

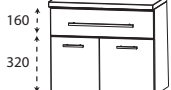
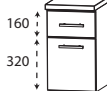

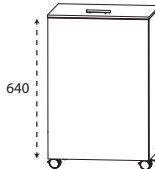
The numbers represent POINTS not prices

Depth indication corresponds to the carcass depth		Depth in mm	Width in mm	Height in mm	Article number	Hinge	Surcharge high-gloss carcass
Wall units							
	Wall unit 2 doors 1 glass shelf 1 top cover 175 mm	150	600	656	O G A 4 1 6 A		95 11
	Wall unit 1 flap door, 1 top cover 255 mm deep	230	600	336	O M A 2 1 6 A	K	73 6
Base units							
	Base unit 1 drawer with buffered closing 1 door 1 top cover 325 mm deep	300 300	300 400	496 496	U N A 3 2 3 A U N A 3 2 4 A	L/R L/R	85 8 96 9
	Base unit 1 drawer with buffered closing 2 doors 1 top cover 325 mm deep	300	600	496	U N A 3 2 6 A		118 10
	Base unit 1 drawer with buffered closing 1 metal pull-out with buffered closing, 1 top cover 325 mm deep	300 300	300 400	496 496	U N A 3 4 3 A U N A 3 4 4 A		112 8 124 9
	Base unit 1 drawer with buffered closing 1 metal pull-out with buffered closing, 1 top cover 325 mm deep	300	600	496	U N A 3 4 6 A		160 10
	Base unit 1 flap door, 1 top cover 255 mm deep	230	600	336	U M A 2 1 6 A	K	73 6
Laundryrolli							
	Laundryrolli 1 flap door, with buffered closing 1 take-out laundry-bag, washable 4 roles Colour version corresponds to the carcass colour incl. height indication rolls (100 mm)	470	470	756	W R S 4 0 4 7		96 16

Please observe suitable accessories in the separate index.

Program 038 - model list

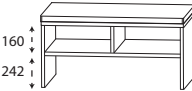
The numbers represent POINTS not prices

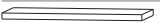
Depth indication corresponds to the carcass depth		Depth in mm	Width in mm	Height in mm	Article number	Hinge	Surcharge high-gloss carcass
Benches							
	Bench 1 shelf 1 seat cushion in imitation leather Colour version corresponds to the carcass colour						
	cushion in creamy-white	450	600	508	SETBANK6W	100	20
	cushion in black	450	600	508	SETBANK6S	100	20
	Bench 2 shelves 1 seat cushion in imitation leather Colour version corresponds to the carcass colour						
	cushion in creamy-white	450	900	508	SETBANK9W	128	24
	cushion in black	450	900	508	SETBANK9S	128	24
Shelves							
	Glass shelf incl. metal holder						
	400 mm wide incl. 2 metal brackets	130	400	8	ABG134008	18	
	600 mm wide incl. 2 metal brackets	130	600	8	ABG136008	20	
	800 mm wide incl. 2 metal brackets	130	800	8	ABG138008	22	
	1000 mm wide incl. 3 metal brackets	130	1000	8	ABG131008	26	
	1200 mm wide incl. 3 metal brackets	130	1200	8	ABG131208	28	
	Push-fit shelf with ABS thick edge all around incl. holders for push fit shelf						
	300 mm wide incl. 2 push-fit holder	150	300	28	SBG6030	12	1
	400 mm wide incl. 2 push-fit holder	150	400	28	SBG6040	14	1
	600 mm wide incl. 2 push-fit holder	150	600	28	SBG6060	19	2
	800 mm wide incl. 3 push-fit holder	150	800	28	SBG6080	24	2
	1000 mm wide incl. 3 push-fit holder	150	1000	28	SBG6010	29	3
	1200 mm wide incl. 3 push-fit holder	150	1200	28	SBG6012	34	3

Please observe suitable accessories in the separate index.

Program 038 - block designation

- 1) PAB-SP06-D1
- 2) PAB-SP06-C1

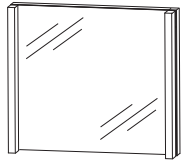

- 1) PAB-SP06-A4
- 2) PAB-SP06-K4

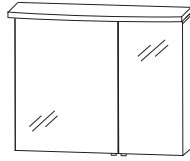

- 1) PAB-SP06-A5
- 2) PAB-SP06-K5

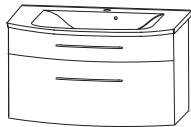
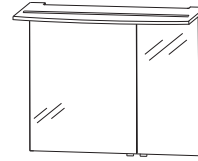

600 mm wide

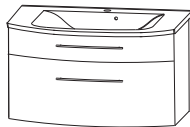

with S2A 4360 55
600 mm wide

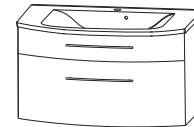

with S2A 4360 55
600 mm wide

- 1) PAB-SP06-A6
- 2) PAB-SP06-K6

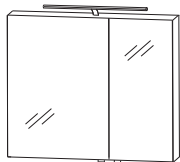

- 1) PAB-SP08-D1
- 2) PAB-SP08-C1

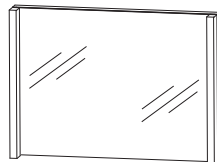

- 1) PAB-SP08-A4
- 2) PAB-SP08-K4

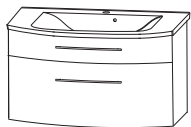
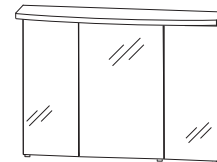

with S2A 4360 A1
600 mm wide

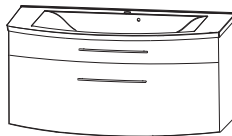

800 mm wide

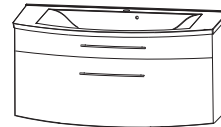

with S2A 4380 55
800 mm wide

- 1) PAB-SP08-A5
- 2) PAB-SP08-K5

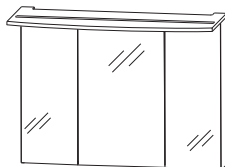

- 1) PAB-SP08-A6
- 2) PAB-SP08-K6

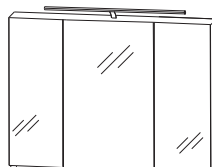

- 1) PAB-SP10-D1
- 2) PAB-SP10-C1

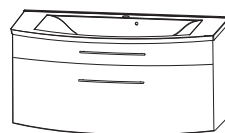
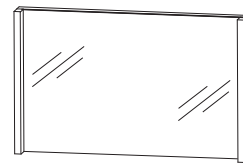

with S2A 4380 81
800 mm wide

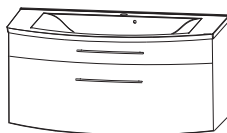

with S2A 4380 A1
800 mm wide

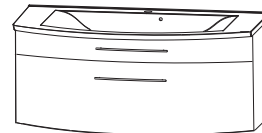

1000 mm wide

- 1) Block with cast mineral washbasin
- 2) Block with ceramic washbasin

Program 038 - block designation

- 1) PAB-SP10-A4
2) PAB-SP10-K4

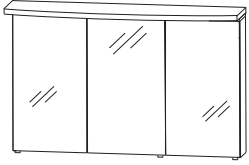

- 1) PAB-SP10-A5
2) PAB-SP10-K5

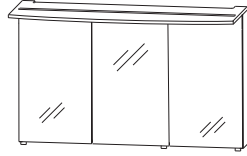

- 1) PAB-SP10-A6
2) PAB-SP10-K6

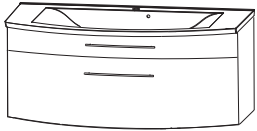
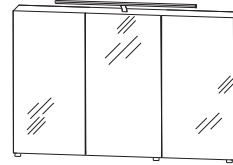

with S2A 4310 55
1000 mm wide

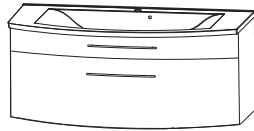

with S2A 4310 81
1000 mm wide

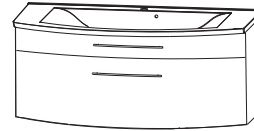

with S2A 4310 A1
1000 mm wide

- 1) PAB-SPEE-D1
2) PAB-SPEE-C1

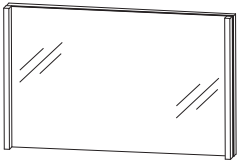

- 1) PAB-SPEE-A4
2) PAB-SPEE-K4

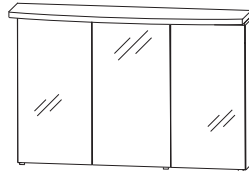

- 1) PAB-SPEE-A5
2) PAB-SPEE-K5

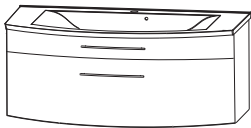
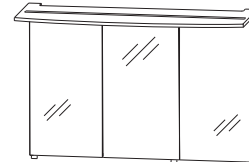

1200 mm wide

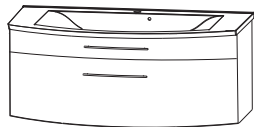

with S2A 4312 55
1200 mm wide

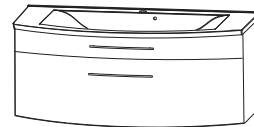

with S2A 4312 81
1200 mm wide

- 1) PAB-SPEE-A6
2) PAB-SPEE-K6

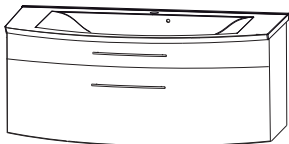
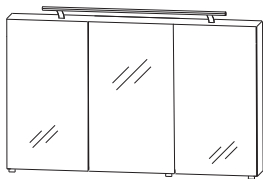

with S2A 4312 A1
1200 mm wide

- 1) Block with cast mineral washbasin
2) Block with ceramic washbasin

Program 038 - dimensional drawings

WMM 8506 1

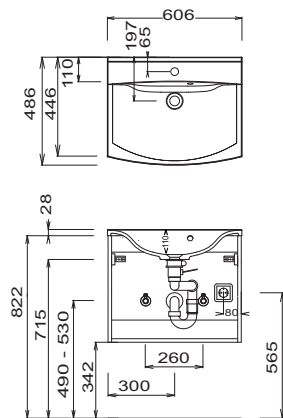

WMM 8508 1

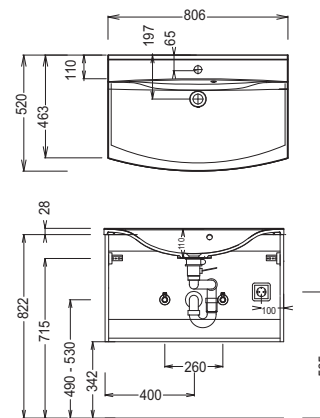

WMM 8510 1

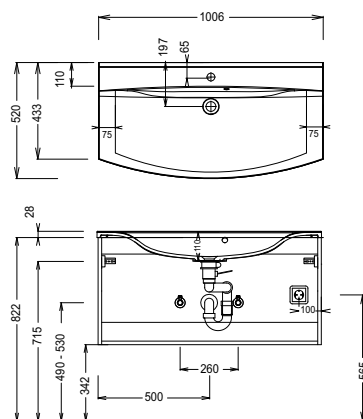

WMM 8520 1

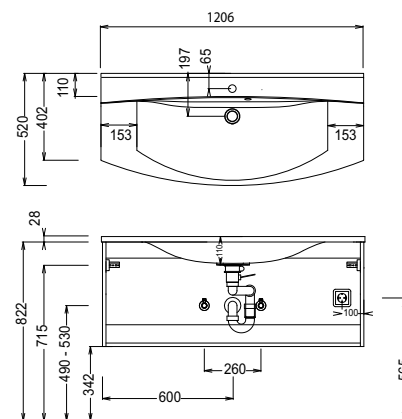

WTM 8506

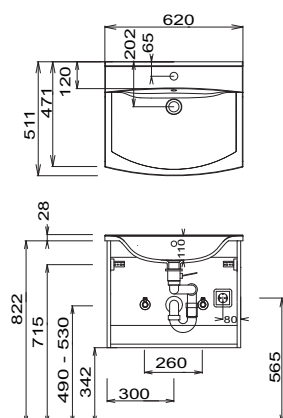

WTM 8508

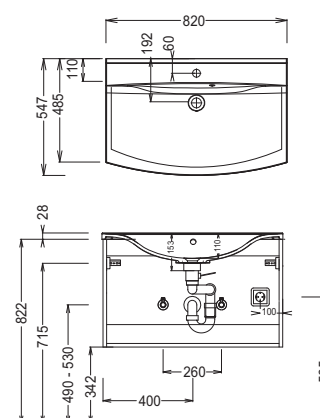

For washing stands with fixing screws, the dimensions for boring must be drawn in on-site after the washing stand has been laid on the floor unit.

Washing stands without anchoring brackets have to be fixed on the wall and on the furniture-side with silicon!

Cast mineral:

The water temperature must not exceed 55° C / 131° F. Hair tinting lotions have to be removed immediately, so that staining can be avoided.

Modifications:

Technical modifications (+/- 5mm) and flatness modifications (DIN 18202) are subject of the usual material-specific modifications for construction materials, based on DIN 18202.

Program 038 - dimensional drawings

WTM 8510

WTM 8520

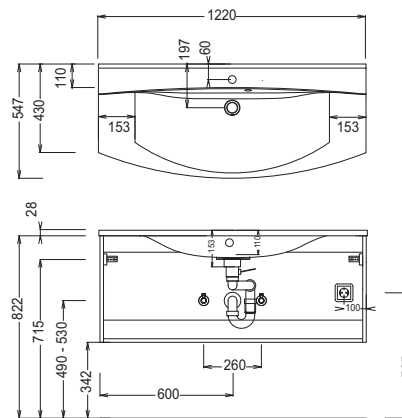
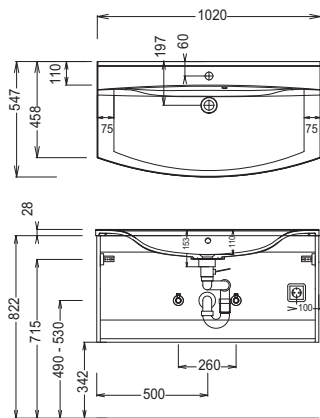

electrical connections for mirror cabinets

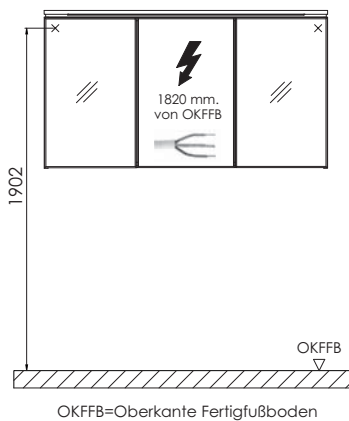

OKFFB=Oberkante Fertigfußboden

For washing stands with fixing screws, the dimensions for boring must be drawn in on-site after the washing stand has been laid on the floor unit.

Washing stands without anchoring brackets have to be fixed on the wall and on the furniture-side with silicon!

Cast mineral:

The water temperature must not exceed 55° C / 131° F. Hair tinting lotions have to be removed immediately, so that staining can be avoided.

Modifications:

Technical modifications (+/- 5mm) and flatness modifications (DIN 18202) are subject of the usual material-specific modifications for construction materials, based on DIN 18202.