

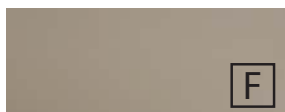

Front colours



No. 764 Stonegrey matt



No. 777 cosmos grey matt



No. 793 noble white matt



No. 891 quarz grey matt



No. 893 titanium grey matt



No. 686 anthracite hgl.



No. 722 polar white hgl.



no. 680 Charleston oak



Nr. 785 natural oak



no. 794 sand oak

F foiled front

carcass colours

* High gloss carcass for an additional price



No. 164
Stonegrey matt



No. 177
cosmos grey
matt



No. 111
white matt



no. 191
quarz grey
matt



No. 193
titanium grey
matt



*no. 121
anthracite hgl.

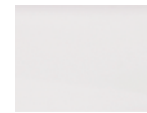

*no. 161
white hgl.



no. 180
Charleston
oak



Nr. 185
natural oak



no. 194
sand oak

Washbasin colours

evermite - washbasins



No. 21
white

evermite®

New, harder, easy-care
surface.

Glass washbasin



no. 82
optiwhite



no. 92
optiwhite matt

Handle version



No. 290 bar handle
chrome

handle-borehole distance
for straight fronts: 96 mm /
384 mm

Technique

Pull outs and drawers

No. 554

door with integrated buffered closing

Mirror cabinets

Series A



Series B



Series C





Illustrations and specifications are without obligation. Technical modifications reserved.

2022/2023 - ID

Please note the instruction for warranty, mounting and care, and the quality agreements as well, at the beginning of the book.

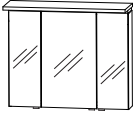
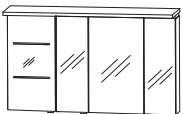
Program 026 - model list

Depth indication corresponds to the carcass depth		Depth in mm	Width in mm	Height in mm	Article number	Hinge
 <p>incl. handle blocks</p> <p>Mirror cabinet- Set consisting of mirror cabinet (S2A 4390 1D) 3 double mirror doors 2 central partitions, 6 glass shelves 1 switch socket element consisting of flyover shelf (GS1 4190 B2) 11,4 watt / converter 30 watt 989 lumens / 6000 Kelvin 1 middle panel Door width: 238 mm / 412 mm / 238 mm This product contains a light source with energy efficiency class: G</p> <p>Additional accessories LED washbasin lighting</p>		150	900	680	SET 4 3 9 0 2	
 <p>incl. handle blocks</p> <p>Mirror cabinet- Set consisting of mirror cabinet (S2A 4390 1D) 3 double mirror doors 2 central partitions, 6 glass shelves 1 switch socket element consisting of mirror cabinet (S2A 433B 1D L) 1 double mirror door 2 sand blasted lightning cut-outs LED 2 enlightened glass shelves 2 X 0,4 watt / converter 30 watt 2 x 18 lumens / 6500 Kelvin consisting of flyover shelf (GS1 4112 BL) LED lighting 11,4 W 1428 lumens / 6000 Kelvin 1 middle panel Door width: 296 mm / 238 mm / 412 mm / 238 mm This product contains a light source with energy efficiency class: G</p> <p>Additional accessories LED washbasin lighting</p>		150	1200	680	SET 4 0 1 2 2 L	
 <p>incl. handle blocks</p> <p>Mirror cabinet- Set consisting of mirror cabinet (S2A 4390 1D) 3 double mirror doors 2 central partitions, 6 glass shelves 1 switch socket element consisting of mirror cabinet (S2A 433B 1D R) 1 double mirror door 2 sand blasted lightning cut-outs LED 2 enlightened glass shelves 2 X 0,4 watt / converter 30 watt 2 x 18 lumens / 6500 Kelvin consisting of flyover shelf (GS1 4112 BR) LED lighting 11,4 W 1428 lumens / 6000 Kelvin 1 middle panel Door width: 238 mm / 412 mm / 238 mm / 296 mm This product contains a light source with energy efficiency class: G</p> <p>Additional accessories LED washbasin lighting</p>		150	1200	680	SET 4 0 1 2 2 R	

Please observe suitable accessories in the separate index.

Program 026 - model list

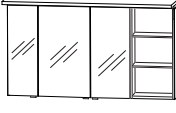
Depth indication corresponds to the carcass depth		Depth in mm	Width in mm	Height in mm	Article number			Hinge
Mirror cabinets Series A								
	<p>Mirror cabinet- Set consisting of mirror cabinet (S2A 4390 1D) 3 double mirror doors 2 central partitions, 6 glass shelves 1 switch socket element consisting of shelf (RG 433B) 2 enlightened glass shelves 2 X 0,4 watt / converter 30 watt 2 x 18 lumens / 6500 Kelvin consisting of flyover shelf (GS1 4112 BL) LED lighting 11,4 W 1428 lumens / 6000 Kelvin 1 middle panel Door width: 238 mm / 412 mm / 238 mm This product contains a light source with energy efficiency class: G</p> <p>Additional accessories LED washbasin lighting</p>	150	1200	680	S E T 4 1 1 2 2 L			
incl. handle blocks					P Z	1 0 6 3 9 0		
	<p>Mirror cabinet- Set consisting of mirror cabinet (S2A 4390 1D) 3 double mirror doors 2 central partitions, 6 glass shelves 1 switch socket element consisting of shelf (RG 433B) 2 enlightened glass shelves 2 X 0,4 watt / converter 30 watt 2 x 18 lumens / 6500 Kelvin consisting of flyover shelf (GS1 4112 BR) LED lighting 11,4 W 1428 lumens / 6000 Kelvin 1 middle panel Door width: 238 mm / 412 mm / 238 mm This product contains a light source with energy efficiency class: G</p> <p>Additional accessories LED washbasin lighting</p>	150	1200	680	S E T 4 1 1 2 2 R			
incl. handle blocks					P Z	1 0 6 3 9 0		

Please observe suitable accessories in the separate index.

Program 026 - model list

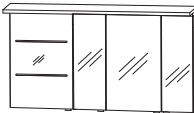
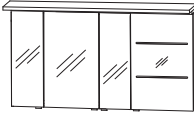
Depth indication corresponds to the carcass depth		Depth in mm	Width in mm	Height in mm	Article number			Hinge						
 <p>Mirror cabinet- Set consisting of mirror cabinet (S2A 4390 1D) 3 double mirror doors 2 central partitions, 6 glass shelves incl. handle blocks 1 switch socket element consisted of mirror cabinet (S2A 435B 1D L) 1 double mirror door 2 sand blasted lightning cut-outs LED 2 enlightened glass shelves 2 X 1 watt / converter 30 watt 2 x 36 lumens / 6500 Kelvin consisting of flyover shelf (GS1 4114 BL) LED lighting 11,4 W 1428 lumens / 6000 Kelvin 1 middle panel Door width: 496 mm / 238 mm / 412 mm / 238 mm This product contains a light source with energy efficiency class: G Additional accessories LED washbasin lighting</p>		150	1400	680	S	E	T	4	0	1	4	2	L	
 <p>Mirror cabinet- Set consisting of mirror cabinet (S2A 4390 1D) 3 double mirror doors 2 central partitions, 6 glass shelves incl. handle blocks 1 switch socket element consisted of mirror cabinet (S2A 435B 1D R) 1 double mirror door 2 sand blasted lightning cut-outs LED 2 enlightened glass shelves 2 X 1 watt / converter 30 watt 2 x 36 lumens / 6500 Kelvin consisting of flyover shelf (GS1 4114 BR) LED lighting 11,4 W 1428 lumens / 6000 Kelvin 1 middle panel Door width: 238 mm / 412 mm / 238 mm / 496 mm This product contains a light source with energy efficiency class: G Additional accessories LED washbasin lighting</p>		150	1400	680	S	E	T	4	0	1	4	2	R	

Please observe suitable accessories in the separate index.

Program 026 - model list

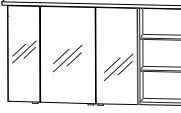
Depth indication corresponds to the carcass depth		Depth in mm	Width in mm	Height in mm	Article number			Hinge
Mirror cabinets Series A								
	<p>Mirror cabinet- Set consisting of mirror cabinet (S2A 4390 1D) 3 double mirror doors 2 central partitions, 6 glass shelves 1 switch socket element consisting of shelf (RG 435B) 2 enlightened glass shelves 2 X 1 watt / converter 30 watt 2 x 36 lumens / 6500 Kelvin consisting of flyover shelf (GS1 4114 BL) LED lighting 11,4 W 1 middle panel 1428 lumens / 6000 Kelvin Door width: 238 mm / 412 mm / 238 mm This product contains a light source with energy efficiency class: G</p> <p>Additional accessories LED washbasin lighting</p>	150	1400	680	S E T 4 1 1 4 2 L			
incl. handle blocks					P Z	1 0 6 3 9 0		
	<p>Mirror cabinet- Set consisting of mirror cabinet (S2A 4390 1D) 3 double mirror doors 2 central partitions, 6 glass shelves 1 switch socket element consisting of shelf (RG 435B) 2 enlightened glass shelves 2 X 1 watt / converter 30 watt 2 x 36 lumens / 6500 Kelvin consisting of flyover shelf (GS1 4114 BR) LED lighting 11,4 W 1428 lumens / 6000 Kelvin 1 middle panel Door width: 238 mm / 412 mm / 238 mm This product contains a light source with energy efficiency class: G</p> <p>Additional accessories LED washbasin lighting</p>	150	1400	680	S E T 4 1 1 4 2 R			
incl. handle blocks					P Z	1 0 6 3 9 0		



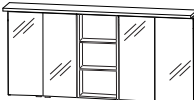

Please observe suitable accessories in the separate index.

Program 026 - model list

Depth indication corresponds to the carcass depth	Depth in mm	Width in mm	Height in mm	Article number	Hinge
<p>Mirror cabinets Series A</p>  <p>Mirror cabinet- Set consisting of 2 mirror cabinets (S2A 4375 1D)à 2 double mirror doors 2 glass shelves 1 switch socket element</p> <p>choose the hinge of the middle-door incl. handle blocks</p> <p>consisting of mirror cabinet (S2A 433B 1D L/R) 1 double mirror door 2 sand blasted lightning cut-outs LED 2 enlightened glass shelves 2 X 0,4 watt / converter 30 watt 2 x 18 lumens / 6500 Kelvin consisting of flyover shelf (GS1 4118 B2) LED lighting 2 X 9,12 Watt 2 x 696 lumens / 6000 Kelvin 1 middle panel Door width: 346 mm / 396 mm / 296 mm / 396 mm / 346 mm This product contains a light source with energy efficiency class: G</p> <p>Additional accessories LED washbasin lighting (please order 2 pieces)</p>	150	1800	680	S E T 4 0 1 8 2	L/R
 <p>Mirror cabinet- Set consisting of 2 mirror cabinets (S2A 4375 1D)à 2 double mirror doors 2 glass shelves 1 switch socket element</p> <p>incl. handle blocks</p> <p>consisting of shelf (RG 433B) 2 enlightened glass shelves 2 X 0,4 watt / converter 30 watt 2 x 18 lumens / 6500 Kelvin consisting of flyover shelf (GS1 4118 B2) LED lighting 2 X 9,12 Watt 2 x 696 lumens / 6000 Kelvin 1 middle panel Door width: 346 mm / 396 mm - 396 mm / 346 mm This product contains a light source with energy efficiency class: G</p> <p>Additional accessories LED washbasin lighting (please order 2 pieces)</p>	150	1800	680	S E T 4 1 1 8 2	

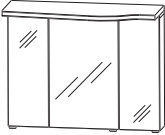

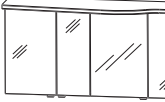

Please observe suitable accessories in the separate index.

Program 026 - model list

Depth indication corresponds to the carcass depth		Depth in mm	Width in mm	Height in mm	Article number			Hinge
 <p>Mirror cabinet- Set consisting of mirror cabinet ((S2A 4390 13) 3 mirror doors on wooden-plated 2 central partitions, 6 glass shelves 1 switch socket element consisting of flyover shelf (GS1 4290 B1) profil milled 3 LED - built-in spotlights 3 X 3,0 / converter 15 watt 3 x 189 lumens / (2600 -) 7400 Kelvin 1 middle panel with chrome edge Door width: 238 mm / 412 mm / 238 mm This product contains a light source with energy efficiency class: G</p> <p>Additional accessories LED washbasin lighting LED washbasin lighting emotion Emotion lighting</p>		150	900	680	S E T	4 3 9 0	3	L/R
 <p>III. = left incl. handle blocks</p>								
 <p>Mirror cabinet- Set consisting of mirror cabinet ((S2A 4390 13) 3 mirror doors on wooden-plated 2 central partitions, 6 glass shelves 1 switch socket element inkl. converter 30 Watt consisting of mirror cabinet (S2A 4330 13) 1 mirror door on wooden-plated outer edges in chrom 2 glass shelves consisting of flyover shelf (GS1 4212 B1) profil milled 4 LED - built-in spotlights 4 x 3,0 watt 4 x 189 lumens / (2600 -) 7400 Kelvin 1 middle panel with chrome edge Door width: 296 mm / 238 mm / 412 mm / 238 mm This product contains a light source with energy efficiency class: G</p> <p>Additional accessories LED washbasin lighting LED washbasin lighting emotion Emotion lighting</p>		150	1200	680	S E T	4 0 1 2	3 L	
 <p>incl. handle blocks</p>								





Please observe suitable accessories in the separate index.

Program 026 - model list

Depth indication corresponds to the carcass depth		Depth in mm	Width in mm	Height in mm	Article number	Hinge
 <p>Mirror cabinet- Set consisting of mirror cabinet ((S2A 4390 13) 3 mirror doors on wooden-plated 2 central partitions, 6 glass shelves 1 switch socket element inkl. converter 30 Watt consisting of mirror cabinet (S2A 4330 13) 1 mirror door on wooden-plated outer edges in chrom 2 glass shelves consisting of flyover shelf (GS1 4212 B1) profil milled 4 LED - built-in spotlights 4 x 3,0 watt 4 x 189 lumens / (2600 -) 7400 Kelvin 1 middle panel with chrome edge Door width: 238 mm / 412 mm / 238 mm / 296 mm This product contains a light source with energy efficiency class: G</p> <p>Additional accessories LED washbasin lighting LED washbasin lighting emotion Emotion lighting</p>		150	1200	680	S E T 4 0 1 2 3 R	
 <p>incl. handle blocks</p>						
 <p>Mirror cabinet- Set consisting of mirror cabinet ((S2A 4390 13) 3 mirror doors on wooden-plated 2 central partitions, 6 glass shelves 1 switch socket element inkl. converter 30 Watt consisting of shelf (RG 433B) 2 enlightened glass shelves 2 x 0,4 watt 2 x 18 lumens / (3000 -) 6500 Kelvin consisting of flyover shelf (GS1 4212 B1) profil milled 4 LED - built-in spotlights 4 x 3,0 watt 4 x 189 lumens / (2600 -) 7400 Kelvin 1 middle panel with chrome edge Door width: 238 mm / 412 mm / 238 mm This product contains a light source with energy efficiency class: G</p> <p>Additional accessories LED washbasin lighting LED washbasin lighting emotion Emotion lighting</p>		150	1200	680	S E T 4 1 1 2 3 L	
 <p>incl. handle blocks</p>						
					P Z 1 0 6 3 90 P Z 1 1 5 0 90 P Z 1 0 2 0 1	





Please observe suitable accessories in the separate index.

Program 026 - model list

Depth indication corresponds to the carcass depth		Depth in mm	Width in mm	Height in mm	Article number	Hinge
  incl. handle blocks		150	1200	680	SET 4 1 1 2 3 R	
<p>Mirror cabinet- Set 3 mirror doors on wooden-plated consisting of mirror cabinet ((S2A 4390 13) 2 central partitions, 6 glass shelves 1 switch socket element inkl. converter 30 Watt consisting of shelf (RG 433B) 2 enlited glass shelves 2 x 0,4 watt 2 x 18 lumens / (3000 -) 6500 Kelvin consisting of flyover shelf (GS1 4212 B1) profil milled 4 LED - built-in spotlights 4 x 3,0 watt 4 x 189 lumens / (2600 -) 7400 Kelvin 1 middle panel with chrome edge Door width: 238 mm / 412 mm / 238 mm This product contains a light source with energy efficien- cy class: G</p> <p>Additional accessories LED washbasin lighting LED washbasin lighting emotion Emotion lighting</p>					P Z 1 0 6 3 90 P Z 1 1 5 0 90 P Z 1 0 2 0 1	
  incl. handle blocks		150	1400	680	SET 4 0 1 4 3 L	
<p>Mirror cabinet- Set consisting of mirror cabinet ((S2A 4390 13) 3 mirror doors on wooden-plated outer edges in chrom 2 central partitions, 6 glass shelves 1 switch socket element inkl. converter 30 Watt consided of mirror cabinet (S2A 4350 13) 1 mirror door on wooden-plated 2 glass shelves consisting of flyover shelf (GS1 4214 B1) profil milled 4 LED - built-in spotlights 4 x 3,0 watt 4 x 189 lumens / (2600 -) 7400 Kelvin 1 middle panel with chrome edge Door width: 496 mm / 238 mm / 412 mm / 238 mm This product contains a light source with energy efficien- cy class: G</p> <p>Additional accessories LED washbasin lighting LED washbasin lighting emotion Emotion lighting</p>					P Z 1 0 6 3 90 P Z 1 1 5 0 90 P Z 1 0 2 0 1	

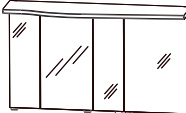

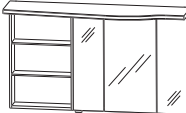

Please observe suitable accessories in the separate index.

Program 026 - model list

Depth indication corresponds to the carcass depth		Depth in mm	Width in mm	Height in mm	Article number	Hinge
 <p>Mirror cabinet- Set consisting of mirror cabinet ((S2A 4390 13) 3 mirror doors on wooden-plated 2 central partitions, 6 glass shelves 1 switch socket element inkl. converter 30 Watt</p> <p> EMOTION incl. handle blocks</p> <p>consisted of mirror cabinet (S2A 4350 13) 1 mirror door on wooden-plated 2 glass shelves consisting of flyover shelf (GS1 4214 B1) profil milled 4 LED - built-in spotlights 4 x 3,0 watt 4 x 189 lumens / (2600 -) 7400 Kelvin 1 middle panel with chrome edge Door width: 238 mm / 412 mm / 238 mm / 496 mm This product contains a light source with energy efficiency class: G</p> <p>Additional accessories LED washbasin lighting LED washbasin lighting emotion Emotion lighting</p>		150	1400	680	SET 4 0 1 4 3 R	
 <p>Mirror cabinet- Set consisting of mirror cabinet ((S2A 4390 13) 3 mirror doors on wooden-plated 2 central partitions, 6 glass shelves 1 switch socket element inkl. converter 30 Watt</p> <p> EMOTION incl. handle blocks</p> <p>consisting of shelf (RG 435B) 2 enlightened glass shelves 2 X 1 Watt 2 x 36 lumens / (3000 -) 6500 Kelvin consisting of flyover shelf (GS1 4214 B1) profil milled 4 LED - built-in spotlights 4 x 3,0 watt 4 x 189 lumens / (2600 -) 7400 Kelvin 1 middle panel with chrome edge Door width: 238 mm / 412 mm / 238 mm This product contains a light source with energy efficiency class: G</p> <p>Additional accessories LED washbasin lighting LED washbasin lighting emotion Emotion lighting</p>		150	1400	680	SET 4 1 1 4 3 L	

Please observe suitable accessories in the separate index.

Program 026 - model list

	Depth in mm	Width in mm	Height in mm	Article number
<p>Depth indication corresponds to the carcass depth</p>				
<h2>Mirror cabinets Series B</h2>				
 <p>Mirror cabinet- Set consisting of mirror cabinet ((S2A 4390 13) 3 mirror doors on wooden-plated 2 central partitions, 6 glass shelves 1 switch socket element inkl. converter 30 Watt consisting of shelf (RG 435B) 2 enlightened glass shelves 2 X 1 Watt 2 x 36 lumens / (3000 -) 6500 Kelvin consisting of flyover shelf (GS1 4214 B1) profil milled 4 LED - built-in spotlights 4 x 3,0 watt 4 x 189 lumens / (2600 -) 7400 Kelvin 1 middle panel with chrome edge Door width: 238 mm / 412 mm / 238 mm This product contains a light source with energy efficiency class: G</p> <p>Additional accessories LED washbasin lighting LED washbasin lighting emotion Emotion lighting</p> <p>incl. handle blocks</p> 	150	1400	680	SET 4 1 1 4 3 R P Z 1 0 6 3 90 P Z 1 1 5 0 90 P Z 1 0 2 0 1
 <p>Mirror cabinet- Set consisting of 2 mirror cabinets (S2A 4375 L/R2)à 2 mirror doors on wooden-plated 2 glass shelves 1 switch socket element LED - converter 30 Watt consisting of mirror cabinet (S2A 4330 13) 1 mirror door on wooden-plated 2 glass shelves consisting of flyover shelf (GS1 4218 B1) profil milled 5 LED - built-in spotlights 5 X 3,0 watt 5 x 189 lumens / (2600 -) 7400 Kelvin 1 middle panel with chrome edge Door width: 346 mm / 396 mm / 296 mm / 396 mm / 346 mm This product contains a light source with energy efficiency class: G</p> <p>Additional accessories LED washbasin lighting (please order 2 pieces) LED washbasin lighting emotion (please order 2 pieces) Emotion lighting</p> <p>choose the hinge of the middle-door incl. handle blocks</p> 	150	1800	680	SET 4 0 1 8 3 L/R P Z 1 0 6 3 60 P Z 1 1 5 0 60 P Z 1 0 2 0 1



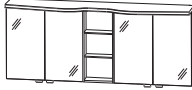
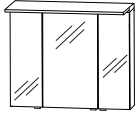

Please observe suitable accessories in the separate index.

Program 026 - model list

Depth indication corresponds to the carcass depth	Depth in mm	Width in mm	Height in mm	Article number	Hinge
<h2>Mirror cabinets Series B</h2>					
 <p>Mirror cabinet- Set consisting of 2 mirror cabinets (S2A 4375 L/R2)à 2 mirror doors on wooden-plated 2 glass shelves 1 switch socket element consisting of shelf (RG 433B) 2 enlightened glass shelves 2 X 0,4 watt / converter 30 watt 2 x 18 lumens / (3000 -) 6500 Kelvin consisting of flyover shelf (GS1 4218 B1) profil milled 5 LED - built-in spotlights 5 X 3,0 watt 5 x 189 lumens / (2600 -) 7400 Kelvin 1 middle panel with chrome edge Door width: 346 mm / 396 mm - 396 mm / 346 mm This product contains a light source with energy efficiency class: G</p> <p>Additional accessories LED washbasin lighting (please order 2 pieces) LED washbasin lighting emotion (please order 2 pieces) Emotion lighting</p> <p>incl. handle blocks</p>	150	1800	680	S E T 4 1 1 8 3 P Z 1 0 6 3 60 P Z 1 1 5 0 60 P Z 1 0 2 0 1	
<h2>Mirror cabinets Series C</h2>					
 <p>Mirror cabinet- Set consisting of mirror cabinet (S2A 4390 1D) 3 double mirror doors 2 central partitions, 6 glass shelves 1 switch socket element consisting of flyover shelf (PZ 1097 90) LED panel light 13,2 watt / converter 30watt 1081 lumens / (2700 -) 6500 Kelvin Door width: 238 mm / 412 mm / 238 mm This product contains a light source with energy efficiency class: F</p> <p>Additional accessories LED washbasin lighting LED washbasin lighting emotion Emotion lighting</p> <p>incl. handle blocks</p>	150	900	660	S E T 4 3 9 0 6 P Z 1 0 6 3 90 P Z 1 1 5 0 90 P Z 1 0 2 0 1	

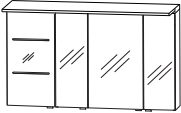

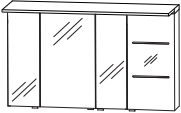

Please observe suitable accessories in the separate index.

Program 026 - model list

Depth indication corresponds to the carcass depth		Depth in mm	Width in mm	Height in mm	Article number	Hinge
Mirror cabinets Series C						
  incl. handle blocks	Mirror cabinet- Set consisting of mirror cabinet (S2A 4390 1D) 3 double mirror doors 2 central partitions, 6 glass shelves 1 switch socket element consisting of mirror cabinet (S2A 433B 1D L) 1 double mirror door 2 sand blasted lightning cut-outs LED 2 enlightened glass shelves 2 X 0,4 watt / converter 30 watt 2 x 18 lumens / (3000 -) 6500 Kelvin consisting of flyover shelf (PZ 1097 12) LED panel light 17,8 watt 1462 lumens / (2700 -) 6500 Kelvin Door width: 296 mm / 238 mm / 412 mm / 238 mm This product contains a light source with energy efficiency class: F Additional accessories LED washbasin lighting LED washbasin lighting emotion Emotion lighting	150	1200	660	S E T 4 0 1 2 6 L P Z 1 0 6 3 9 0 P Z 1 1 5 0 9 0 P Z 1 0 2 0 1	
  incl. handle blocks	Mirror cabinet- Set consisting of mirror cabinet (S2A 4390 1D) 3 double mirror doors 2 central partitions, 6 glass shelves 1 switch socket element consisting of mirror cabinet (S2A 433B 1D R) 1 double mirror door 2 sand blasted lightning cut-outs LED 2 X 0,4 watt / converter 30 watt 2 x 18 lumens / (3000 -) 6500 Kelvin 2 enlightened glass shelves consisting of flyover shelf (PZ 1097 12) LED panel light 17,8 watt 1462 lumens / (2700 -) 6500 Kelvin Door width: 238 mm / 412 mm / 238 mm / 296 mm This product contains a light source with energy efficiency class: F Additional accessories LED washbasin lighting LED washbasin lighting emotion Emotion lighting	150	1200	660	S E T 4 0 1 2 6 R P Z 1 0 6 3 9 0 P Z 1 1 5 0 9 0 P Z 1 0 2 0 1	



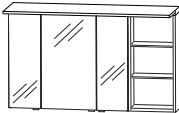

Please observe suitable accessories in the separate index.

Program 026 - model list

Depth indication corresponds to the carcass depth		Depth in mm	Width in mm	Height in mm	Article number	Hinge
 <p>Mirror cabinet- Set consisting of mirror cabinet (S2A 4390 1D) 3 double mirror doors 2 central partitions, 6 glass shelves 1 switch socket element consisting of shelf (RG 433B) 2 enlighthed glass shelves 2 X 1 Watt 2 x 18 lumens / (3000 -) 6500 Kelvin consisting of flyover shelf (PZ 1097 12) LED panel light 17,8 watt / converter 30 watt 1462 lumens / (2700 -) 6500 Kelvin Door width: 238 mm / 412 mm / 238 mm This product contains a light source with energy efficiency class: F</p> <p>Additional accessories LED washbasin lighting LED washbasin lighting emotion Emotion lighting</p>		150	1200	660	S E T 4 1 1 2 6 L	
 <p>incl. handle blocks</p>						
 <p>Mirror cabinet- Set consisting of mirror cabinet (S2A 4390 1D) 3 double mirror doors 2 central partitions, 6 glass shelves 1 switch socket element consisting of shelf (RG 433B) 2 enlighthed glass shelves 2 X 1 Watt 2 x 18 lumens / (3000 -) 6500 Kelvin consisting of flyover shelf (PZ 1097 12) LED panel light 17,8 watt / converter 30 watt 1462 lumens / (2700 -) 6500 Kelvin Door width: 238 mm / 412 mm / 238 mm This product contains a light source with energy efficiency class: F</p> <p>Additional accessories LED washbasin lighting LED washbasin lighting emotion Emotion lighting</p>		150	1200	660	S E T 4 1 1 2 6 R	
 <p>incl. handle blocks</p>						

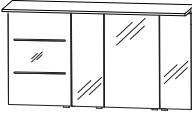

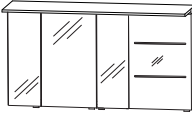



Please observe suitable accessories in the separate index.

Program 026 - model list

Depth indication corresponds to the carcass depth	Depth in mm	Width in mm	Height in mm	Article number	Hinge
<p>Mirror cabinets Series C</p>  <p>Mirror cabinet- Set consisting of mirror cabinet (S2A 4390 1D) 3 double mirror doors 2 central partitions, 6 glass shelves 1 switch socket element</p>  <p>incl. handle blocks</p> <p>consisted of mirror cabinet (S2A 435B 1D L) 1 double mirror door 2 sand blasted lightning cut-outs LED 2 X 0,4 watt / converter 30 watt 2 x 36 lumens / (3000 -) 6500 Kelvin 2 enlightened glass shelves consisting of flyover shelf (PZ 1097 14) LED panel light 20,9 watt 1716 lumens / (2700 -) 6500 Kelvin Door width: 496 mm / 238 mm / 412 mm / 238 mm This product contains a light source with energy efficiency class: F</p> <p>Additional accessories LED washbasin lighting LED washbasin lighting emotion Emotion lighting</p>	150	1400	660	SET 4 0 1 4 6 L P Z 1 0 6 3 9 0 P Z 1 1 5 0 9 0 P Z 1 0 2 0 1	
 <p>Mirror cabinet- Set consisting of mirror cabinet (S2A 4390 1D) 3 double mirror doors 2 central partitions, 6 glass shelves 1 switch socket element</p>  <p>incl. handle blocks</p> <p>consisted of mirror cabinet (S2A 435B 1D R) 1 double mirror door 2 sand blasted lightning cut-outs LED 2 X 0,4 watt / converter 30 watt 2 x 36 lumens / (3000 -) 6500 Kelvin 2 enlightened glass shelves consisting of flyover shelf (PZ 1097 14) LED panel light 20,9 watt 1716 lumens / (2700 -) 6500 Kelvin Door width: 238 mm / 412 mm / 238 mm / 496 mm This product contains a light source with energy efficiency class: F</p> <p>Additional accessories LED washbasin lighting LED washbasin lighting emotion Emotion lighting</p>	150	1400	660	SET 4 0 1 4 6 R P Z 1 0 6 3 9 0 P Z 1 1 5 0 9 0 P Z 1 0 2 0 1	













Please observe suitable accessories in the separate index.

Program 026 - model list

Depth indication corresponds to the carcass depth		Depth in mm	Width in mm	Height in mm	Article number	Hinge
Mirror cabinets Series C						
  incl. handle blocks	Mirror cabinet- Set consisting of mirror cabinet (S2A 4390 1D) 3 double mirror doors 2 central partitions, 6 glass shelves 1 switch socket element consisting of shelf (RG 435B) 2 enlighthed glass shelves 2 X 1 Watt 2 x 36 lumens / (3000 -) 6500 Kelvin consisting of flyover shelf (PZ 1097 14) LED panel light 20,9 watt / converter 30 watt 1716 lumens / (2700 -) 6500 Kelvin Door width: 238 mm / 412 mm / 238 mm This product contains a light source with energy efficiency class: F Additional accessories LED washbasin lighting LED washbasin lighting emotion Emotion lighting	150	1400	660	SET 4 1 1 4 6 L	
  incl. handle blocks	Mirror cabinet- Set consisting of mirror cabinet (S2A 4390 1D) 3 double mirror doors 2 central partitions, 6 glass shelves 1 switch socket element consisting of shelf (RG 435B) 2 enlighthed glass shelves 2 X 1 Watt 2 x 36 lumens / (3000 -) 6500 Kelvin consisting of flyover shelf (PZ 1097 14) LED panel light 20,9 watt / converter 30 watt 1716 lumens / (2700 -) 6500 Kelvin Door width: 238 mm / 412 mm / 238 mm This product contains a light source with energy efficiency class: F Additional accessories LED washbasin lighting LED washbasin lighting emotion Emotion lighting	150	1400	660	SET 4 1 1 4 6 R	
evermite - washbasins						
  evermite	evermite washbasin, 900 mm white inkl. concealed overflow system chrome finish can be combined with WUA 3690 1M L Additional accessories Additional price for Washbasin without tap hole / with 3 holes (acc. to sketch).	515	906	15	WMM 5 2 9 L 2 1	

Please observe suitable accessories in the separate index.









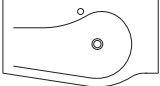

Program 026 - model list

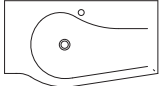
Depth indication corresponds to the carcass depth		Depth in mm	Width in mm	Height in mm	Article number	Hinge
evermite - washbasins						
	evermite washbasin, 900 mm white inkl. concealed overflow system chrome finish can be combined with WUA 3690 1M R Additional accessories Additional price for Washbasin without tap hole / with 3 holes (acc. to sketch).	515	906	15	WMM 5 2 9 R 2 1	
 evermite						
	evermite washbasin, 1200 mm white inkl. concealed overflow system chrome finish extention left can be combined with WUA 3690 1M L, UTA 3630 1M Additional accessories Additional price for Washbasin without tap hole / with 3 holes (acc. to sketch).	515	1206	15	WMM 5 2 2 L 2 1	
						
	evermite washbasin, 1200 mm white inkl. concealed overflow system chrome finish extension right can be combined with WUA 3690 1M R, UTA 3630 1M Additional accessories Additional price for Washbasin without tap hole / with 3 holes (acc. to sketch).	515	1206	15	WMM 5 2 2 R 2 1	
						
	evermite washbasin, 1400 mm white inkl. concealed overflow system chrome finish extention left can be combined with WUA 3690 1M L, UTA 3650 1M Additional accessories Additional price for Washbasin without tap hole / with 3 holes (acc. to sketch).	515	1406	15	WMM 5 2 4 L 2 1	
						
	evermite washbasin, 1400 mm white inkl. concealed overflow system chrome finish extension right can be combined with WUA 3690 1M R, UTA 3650 1M Additional accessories Additional price for Washbasin without tap hole / with 3 holes (acc. to sketch).	515	1406	15	WMM 5 2 4 R 2 1	
						
	evermite double washbasin, 1800 mm white inkl. concealed overflow system chrome finish can be combined with WUA 3690 1M L, WUA 3690 1M R Additional accessories Additional price for Washbasin without tap hole / with 3 holes (acc. to sketch).	515	1806	15	WMM 5 2 8 D 2 1	
						

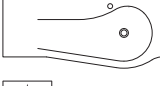
You find information on the the washbasin manufacturer at the beginning of the sales book.

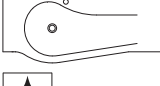
***Delivery time: 8 weeks. Price per washbasin. Washbasin without tap hole is incompatible with CLOU System. Please check your order confirmation for correctness.**









Program 026 - model list

Depth indication corresponds to the carcass depth		Depth in mm	Width in mm	Height in mm	Article number		Hinge
Glass washbasin							
	Glass washbasin, 900 mm Colour Optiwhite	520	912	13	WGM 5 0 9 L 8 2		
	Colour Optiwhite matt	520	912	13	WGM 5 0 9 L 9 2		
	extention left inkl. concealed overflow system chrome finish can be combined with WUA 3690 1M L						
	Additional accessories Neutrally bonding silicone for glass washbasins Surcharge for washbasins without tap-hole or with 3 holes (according to sketch)				P Z 1 2 3 5		
	Glass washbasin, 900 mm Colour Optiwhite	520	912	13	WGM 5 0 9 R 8 2		
	Colour Optiwhite matt	520	912	13	WGM 5 0 9 R 9 2		
	extention right inkl. concealed overflow system chrome finish can be combined with WUA 3690 1M R						
	Additional accessories Neutrally bonding silicone for glass washbasins Surcharge for washbasins without tap-hole or with 3 holes (according to sketch)				P Z 1 2 3 5		
	Glass washbasin, 1200 mm Colour Optiwhite	520	1212	13	WGM 5 1 2 L 8 2		
	Colour Optiwhite matt	520	1212	13	WGM 5 1 2 L 9 2		
	extention left inkl. concealed overflow system chrome finish can be combined with WUA 3690 1M L, UTA 3630 1M						
	Additional accessories Neutrally bonding silicone for glass washbasins Surcharge for washbasins without tap-hole or with 3 holes (according to sketch)				P Z 1 2 3 5		
	Glass washbasin, 1200 mm Colour Optiwhite	520	1212	13	WGM 5 1 2 R 8 2		
	Colour Optiwhite matt	520	1212	13	WGM 5 1 2 R 9 2		
	extention right inkl. concealed overflow system chrome finish can be combined with WUA 3690 1M R, UTA 3630 1M						
	Additional accessories Neutrally bonding silicone for glass washbasins Surcharge for washbasins without tap-hole or with 3 holes (according to sketch)				P Z 1 2 3 5		
	Glass washbasin, 1400 mm Colour Optiwhite	520	1412	13	WGM 5 1 4 L 8 2		
	Colour Optiwhite matt	520	1412	13	WGM 5 1 4 L 9 2		
	extention left inkl. concealed overflow system chrome finish can be combined with WUA 3690 1M L, UTA 3650 1M						
	Additional accessories Neutrally bonding silicone for glass washbasins Surcharge for washbasins without tap-hole or with 3 holes (according to sketch)				P Z 1 2 3 5		

You find information on the the washbasin manufacturer at the beginning of the sales book.

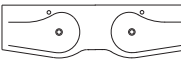

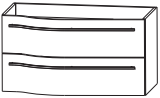
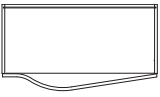
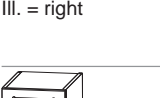
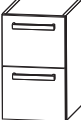
***Delivery time: 8 weeks. Price per washbasin. Washbasin without tap hole is incompatible with CLOU System. Please check your order confirmation for correctness.**

Program 026 - model list

	Depth in mm	Width in mm	Height in mm	Article number	Hinge
Depth indication corresponds to the carcass depth					
Glass washbasin					
  					
<p>Glass washbasin, 1400 mm Colour Optiwhite Colour Optiwhite matt</p> <p>extension right inkl. concealed overflow system chrome finish can be combined with WUA 3690 1M R, UTA 3650 1M</p> <p>Additional accessories Neutrally bonding silicone for glass washbasins Surcharge for washbasins without tap-hole or with 3 holes (according to sketch)</p>	520 520	1412 1412	13 13	WGM 5 1 4 R 8 2 WGM 5 1 4 R 9 2	
				P Z 1 2 3 5	
  					
<p>Glass double washbasin, 1800 mm Colour Optiwhite Colour Optiwhite matt</p> <p>inkl. concealed overflow system chrome finish can be combined with WUA 3690 1M L, WUA 3690 1M R</p> <p>Additional accessories Neutrally bonding silicone for glass washbasins Surcharge for washbasins without tap-hole or with 3 holes (according to sketch)</p>	520 520	1812 1812	13 13	WGM 5 1 8 D 8 2 WGM 5 1 8 D 9 2	
				P Z 1 2 3 5	
Washbasin base units					
  					
<p>Washbasin base unit 1 drawer with buffered closing 1 metal pull-out with buffered closing incl. drawer rail</p> <p>Additional accessories Space-saving drain stench trap DN 40 Space-saving drain stench trap DN 32</p> <p>Ill. = right</p>	500	900	480	WUA 3 6 9 0 1 M	L/R
				P Z 1 3 6 7 P Z 1 4 2 3	
	400	300	480	UTA 3 6 3 0 1 M	
<p>washbasin base unit (additional element) 2 metal pull-out units with buffered closing incl. drawer rail</p>					
	400	500	480	UTA 3 6 5 0 1 M	
<p>washbasin base unit (additional element) 2 metal pull-out units with buffered closing incl. drawer rail</p>					

You find information on the the washbasin manufacturer at the beginning of the sales book.
 *Delivery time: 8 weeks. Price per washbasin. Washbasin without tap hole is incompatible with CLOU System. Please check your order confirmation for correctness.

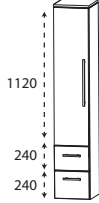
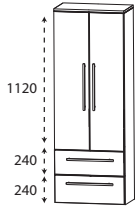
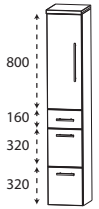
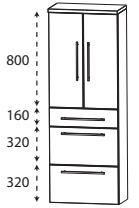
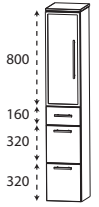
Program 026 - model list

Depth indication corresponds to the carcass depth		Depth in mm	Width in mm	Height in mm	Article number	Hinge
	Tall unit 1 door 4 glass shelves 2 metal pull-outs with buffered closing 1 top cover 330 mm deep	300	300	1628	HNA083A71	L/R
		300	400	1628	HNA084A71	L/R
	Tall unit 2 doors 4 glass shelves 2 metal pull-outs with buffered closing 1 top cover 330 mm deep	300	600	1628	HNA086A71	
	Tall unit 1 door 2 glass shelves (top) 2 metal pull-outs with buffered closing 1 drawer with buffered closing 1 top cover 330 mm deep	300	300	1628	HNA093A7M	L/R
		300	400	1628	HNA094A7M	L/R
	Tall unit 2 doors 2 glass shelves (top) 2 metal pull-outs with buffered closing 1 drawer with buffered closing 1 top cover 330 mm deep	300	600	1628	HNA096A7M	
	Tall unit 1 aluminium framed door with satined glass 2 glass shelves (top) 2 metal pull-outs with buffered closing 1 drawer with buffered closing 1 top cover 330 mm deep	300	300	1628	HNA093B7M	L/R
	Tall unit 2 aluminium framed doors with satined glass 2 glass shelves (top) 2 metal pull-outs with buffered closing 1 drawer with buffered closing 1 top cover 330 mm deep	300	600	1628	HNA096B7M	

Please observe suitable accessories in the separate index.

Program 026 - model list



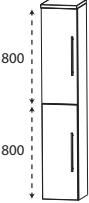
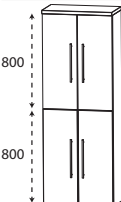
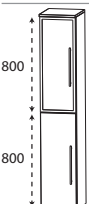
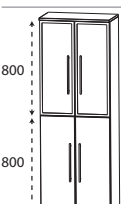
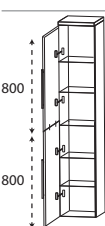

Depth indication corresponds to the carcass depth

Tall units

	Depth in mm	Width in mm	Height in mm	Article number	Hinge
	300	300	1628	H N A 0 3 3 A 7	L/R
	300	400	1628	H N A 0 3 4 A 7	L/R
	150-299	300	1628	H V A 0 3 3 0	L/R
	150-299	400	1628	H V A 0 3 4 0	L/R
	300	600	1628	H N A 0 3 6 A 7	
	150-299	600	1628	H V A 0 3 6 0	
	300	300	1628	H N A 0 3 3 B 7	L/R
	150-299	300	1628	H V A 0 3 3 1	L/R
	300	600	1628	H N A 0 3 6 B 7	
	150-299	600	1628	H V A 0 3 6 1	
	300	300	1628	H N A 0 3 3 A 7 1	L/R
	300	400	1628	H N A 0 3 4 A 7 1	L/R

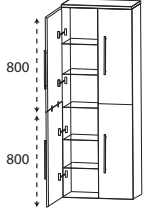
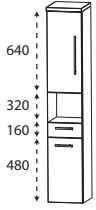

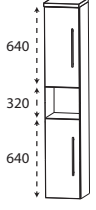
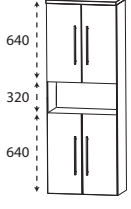
Please observe suitable accessories in the separate index.

Program 026 - model list

Depth indication corresponds to the carcass depth		Depth in mm	Width in mm	Height in mm	Article number	Hinge
Tall units						
	Tall unit for brooms 2 strapped doors left 2 strapped doors right 5 continuously glass shelves 1 top cover 330 mm deep	300	600	1628	HNA036A71	
	Tall unit 1 door 1 glass shelf (top) 1 open compartment 1 drawer with buffered closing 1 door 1 glass shelf 1 top cover 330 mm deep	300	300	1628	HNA023A71	L/R
		300	400	1628	HNA024A71	L/R
	Tall unit 2 doors 1 glass shelf (top) 1 open compartment 1 drawer with buffered closing 2 doors 1 glass shelf 1 top cover 330 mm deep	300	600	1628	HNA026A71	
	Tall unit 1 door 1 glass shelf (top) 1 open compartment 1 door 1 glass shelf 1 top cover 330 mm deep	300	300	1628	HNA023A72	L/R
		300	400	1628	HNA024A72	L/R
	Tall unit 2 doors 1 glass shelf (top) 1 open compartment 2 doors 1 glass shelf 1 top cover 330 mm deep	300	600	1628	HNA026A72	
	Tall unit 1 door 1 glass shelf (top) 2 metal pull-outs with buffered closing, 1 door 1 glass shelf 1 top cover 330 mm deep	300	300	1628	HNA043A71	L/R
		300	400	1628	HNA044A71	L/R

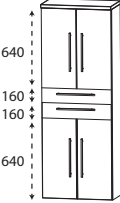
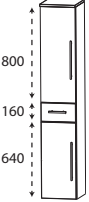
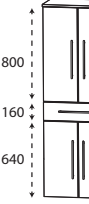
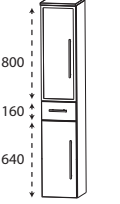
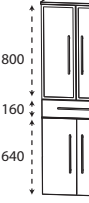
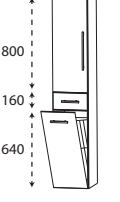

Please observe suitable accessories in the separate index.

Program 026 - model list

Depth indication corresponds to the carcass depth		Depth in mm	Width in mm	Height in mm	Article number			Hinge
Tall units								
	<p>Tall unit 2 doors 1 glass shelf (top) 2 metal pull-outs with buffered closing, 2 doors 1 glass shelf 1 top cover 330 mm deep</p>	300	600	1628	HNA046A71			
	<p>Tall unit 1 door 2 glass shelves (top) 1 drawer with buffered closing 1 door 1 glass shelf 1 top cover 330 mm deep</p>	300	300	1628	HNA053A7M	L/R		
	<p>Tall unit 1 door 2 glass shelves (top) 1 drawer with buffered closing 1 door 1 glass shelf 1 top cover 330 mm deep</p>	300	400	1628	HNA054A7M	L/R		
	<p>Tall unit 2 doors 2 glass shelves (top) 1 drawer with buffered closing 2 doors 1 glass shelf 1 top cover 330 mm deep</p>	300	600	1628	HNA056A7M			
	<p>Tall unit 1 aluminium framed door with satined glass 2 glass shelves (top) 1 drawer with buffered closing 1 door 1 glass shelf 1 top cover 330 mm deep</p>	300	300	1628	HNA053B7M	L/R		
	<p>Tall unit 2 aluminium framed doors with satined glass 2 glass shelves (top) 1 drawer with buffered closing 2 doors 1 glass shelf 1 top cover 330 mm deep</p>	300	600	1628	HNA056B7M			
	<p>Tall unit with laundry basket 1 door 2 glass shelves 1 drawer with buffered closing 1 laundry basket with wire basket 1 top cover 330 mm deep</p>							
	Volume of laundry basket: 25 liters	300	300	1628	HNA053A7W	L/R		
	Volume of laundry basket: 35 liters	300	400	1628	HNA054A7W	L/R		

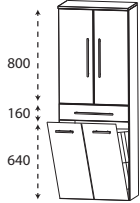
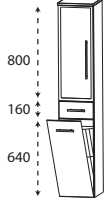

Please observe suitable accessories in the separate index.

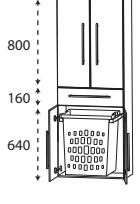
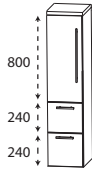
Program 026 - model list

Depth indication corresponds to the carcass depth		Depth in mm	Width in mm	Height in mm	Article number	Hinge
Tall units						
	<p>Tall unit with laundry basket 2 doors 2 glass shelves 1 drawer with buffered closing 1 laundry basket with wire basket 1 top cover 330 mm deep</p> <p>Volume of laundry basket: 55 liters</p>	300	600	1628	H N A 0 5 6 A 7 W	
	<p>Tall unit with laundry basket 1 aluminium framed door with satined glass 2 glass shelves 1 drawer with buffered closing 1 laundry basket with wire basket 1 top cover 330 mm deep</p> <p>Volume of laundry basket: 25 liters</p>	300	300	1628	H N A 0 5 3 B 7 W	L/R
	<p>Tall unit with laundry basket 2 aluminium framed doors with satined glass 2 glass shelves 1 drawer with buffered closing 1 laundry basket with wire basket 1 top cover 330 mm deep</p> <p>Volume of laundry basket: 55 liters</p>	300	600	1628	H N A 0 5 6 B 7 W	
	<p>Tall unit with laundry pull out 2 doors 2 glass shelves (top) 1 drawer with buffered closing 2 doors 1 laundry pull out with wire basket 1 top cover 330 mm deep</p> <p>Volume of laundry pull out: 40 liters</p>	300	600	1628	H N A 0 5 6 A 1 W	
Central units						
	<p>medium-high unit 1 door 2 glass shelves (top) 2 metal pull-outs with buffered closing 1 top cover 330 mm deep</p>	300	300	1308	M N A 8 7 3 A	7 L/R
		300	400	1308	M N A 8 7 4 A	7 L/R

Please observe suitable accessories in the separate index.

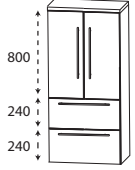
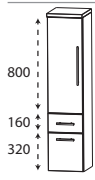
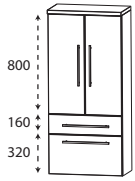
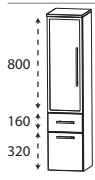
Program 026 - model list

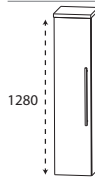
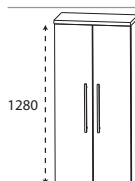
Depth indication corresponds to the carcass depth		Depth in mm	Width in mm	Height in mm	Article number	Hinge
Central units						
	medium-high unit 2 doors 2 glass shelves (top) 2 metal pull-outs with buffered closing 1 top cover 330 mm deep	300	600	1308	M N A 8 7 6 A 7	
	medium-high unit 1 door 2 glass shelves (top) 1 metal pull-out with buffered closing, 1 drawer with buffered closing 1 top cover 330 mm deep	300	300	1308	M N A 8 8 3 A 7 M	L/R
		300	400	1308	M N A 8 8 4 A 7 M	L/R
	medium-high unit 2 doors 2 glass shelves (top) 1 metal pull-out with buffered closing, 1 drawer with buffered closing 1 top cover 330 mm deep	300	600	1308	M N A 8 8 6 A 7 M	
	medium-high unit 1 aluminium framed door with satined glass 2 glass shelves (top) 1 metal pull-out with buffered closing, 1 drawer with buffered closing 1 top cover 330 mm deep	300	300	1308	M N A 8 8 3 B 7 M	L/R
	medium-high unit 2 aluminium framed doors with satined glass 2 glass shelves (top) 1 metal pull-out with buffered closing, 1 drawer with buffered closing 1 top cover 330 mm deep	300	600	1308	M N A 8 8 6 B 7 M	
	medium-high unit 1 door 4 glass shelves 1 top cover 330 mm deep Variable in width: please quote the exact dimension of carcass depth. Top cover will be adapted to the cupboard width.	300	300	1308	M N A 8 1 3 A 7	L/R
		300	400	1308	M N A 8 1 4 A 7	L/R
		150-299	300	1308	M V A 8 1 3 0	L/R
		150-299	400	1308	M V A 8 1 4 0	L/R
	medium-high unit 2 doors 4 glass shelves 1 top cover 330 mm deep Variable in width: please quote the exact dimension of carcass depth. Top cover will be adapted to the cupboard width.	300	600	1308	M N A 8 1 6 A 7	
		150-299	600	1308	M V A 8 1 6 0	

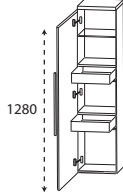
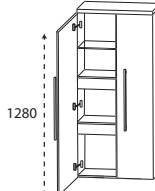
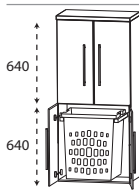
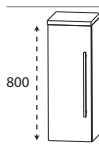
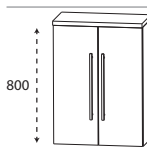

Please observe suitable accessories in the separate index.

Program 026 - model list

Depth indication corresponds to the carcass depth		Depth in mm	Width in mm	Height in mm	Article number		Hinge
Central units							
	medium-high unit with inside drawers 1 door 2 inside metal-drawer with buffered closing 1 glass shelf 1 top cover 330 mm deep	300	300	1308	M N A 8 4 3 A	7	L/R
		300	400	1308	M N A 8 4 4 A	7	L/R
	medium-high unit with inside drawers 2 doors 2 continuously inside metal-drawer with buffered closing 1 continuous glass shelf 1 top cover 330 mm deep	300	600	1308	M N A 8 4 6 A	7	
	medium-high unit with laundry pull out 2 doors 1 glass shelf (top) 2 doors 1 laundry pull out with wire basket Volume of laundry pull out: 40 liters 1 top cover 330 mm deep	300	600	1308	M N A 8 3 6 A 1 W		
Highboards							
	Highboard 1 door 2 glass shelves 1 top cover 330 mm deep	300	300	828	H B A 5 1 3 A	7	L/R
		300	400	828	H B A 5 1 4 A	7	L/R
	Variable in width: please quote the exact dimension of carcass depth. Top cover will be adapted to the cupboard width.	150-299	300	828	H B V A 5 1 3		L/R
		150-299	400	828	H B V A 5 1 4		L/R
	Highboard 2 doors 2 glass shelves 1 top cover 330 mm deep	300	600	828	H B A 5 1 6 A	7	
	Variable in width: please quote the exact dimension of carcass depth. Top cover will be adapted to the cupboard width.	150-299	600	828	H B V A 5 1 6		

Please observe suitable accessories in the separate index.

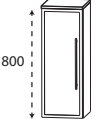
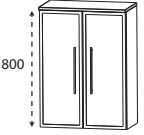
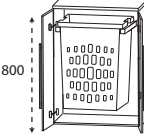
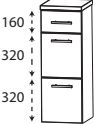
Program 026 - model list

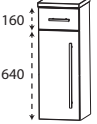
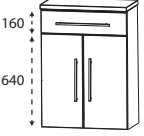
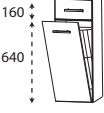
Depth indication corresponds to the carcass depth		Depth in mm	Width in mm	Height in mm	Article number	Hinge
	Highboard 1 aluminium framed door with satined glass 2 glass shelves 1 top cover 330 mm deep	300	300	828	H B A 5 1 3 B 7	L/R
	Variable in width: please quote the exact dimension of carcass depth. Top cover will be adapted to the cupboard width.	150-299	300	828	H B V A 5 1 3 1	L/R
	Highboard 2 aluminium framed doors with satined glass 2 glass shelves 1 top cover 330 mm deep	300	600	828	H B A 5 1 6 B 7	
	Variable in width: please quote the exact dimension of carcass depth. Top cover will be adapted to the cupboard width.	150-299	600	828	H B V A 5 1 6 1	
	Highboard with laundry pull out 2 doors 1 laundry pull out with wire basket 1 top cover 330 mm deep Volume of laundry pull out: 40 liters	300	600	828	H B A 5 1 6 A 1 W	
	Highboard 1 drawer with buffered closing 2 metal pull-outs with buffered closing 1 top cover 330 mm deep	300	300	828	H B A 5 6 3 A 7 M	
		300	400	828	H B A 5 6 4 A 7 M	
	Highboard 1 drawer with buffered closing 2 metal pull-outs with buffered closing 1 top cover 330 mm deep	300	600	828	H B A 5 6 6 A 7 M	
	Highboard 1 drawer with buffered closing 1 door 1 glass shelf 1 top cover 330 mm deep	300	300	828	H B A 5 5 3 A 7 M	L/R
		300	400	828	H B A 5 5 4 A 7 M	L/R
	Highboard 1 drawer with buffered closing 2 doors 1 glass shelf 1 top cover 330 mm deep	300	600	828	H B A 5 5 6 A 7 M	
	Highboard with laundry basket 1 drawer with buffered closing 1 laundry basket with wire basket 1 top cover 330 mm deep Volume of laundry basket: 25 liters	300	300	828	H B A 5 5 3 A 7 W	
	Volume of laundry basket: 35 liters	300	400	828	H B A 5 5 4 A 7 W	



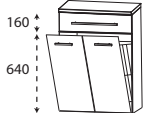
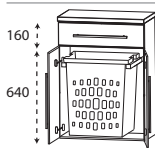
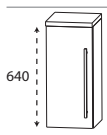
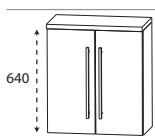
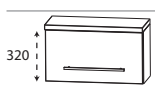
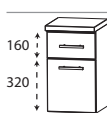
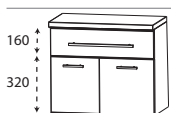

Please observe suitable accessories in the separate index.

Program 026 - model list

Depth indication corresponds to the carcass depth		Depth in mm	Width in mm	Height in mm	Article number	Hinge
Highboards						
	<p>Highboard with laundry basket 1 drawer with buffered closing 1 laundry basket with wire basket 1 top cover 330 mm deep</p> <p>Volume of laundry basket: 55 liters</p>	300	600	828	H B A 5 5 6 A 7 W	
	<p>Highboard with laundry pull out 1 drawer with buffered closing 2 doors 1 laundry pull out with wire basket 1 top cover 325 mm deep</p> <p>Volume of laundry pull out: 40 liters</p>	300	600	828	H B A 5 5 6 A 1 W	
Wall units						
	<p>Wall unit 1 door 1 glass shelf 1 top cover 180 mm deep</p> <p>Variable in width: please quote the exact dimension of carcass depth. Top cover will be adapted to the cupboard width.</p>	150	300	668	O G A 4 1 3 A 7	L/R
		150	400	668	O G A 4 1 4 A 7	L/R
		151-300	300	668	O V A 4 1 3 0	L/R
		151-300	400	668	O V A 4 1 4 0	L/R
	<p>Wall unit 2 doors 1 glass shelf 1 top cover 180 mm deep</p> <p>Variable in width: please quote the exact dimension of carcass depth. Top cover will be adapted to the cupboard width.</p>	150	600	668	O G A 4 1 6 A 7	
		151-300	600	668	O V A 4 1 6 0	
	<p>Wall unit 1 flap door, 1 top cover 260 mm deep</p>	230	600	348	O M A 2 1 6 A 7 K	
Base units						
	<p>Base unit 1 drawer with buffered closing 1 door 1 top cover 330 mm deep</p>	300	300	508	U N A 3 2 3 A 7 M	L/R
		300	400	508	U N A 3 2 4 A 7 M	L/R
	<p>Base unit 1 drawer with buffered closing 2 doors 1 top cover 330 mm deep</p>	300	600	508	U N A 3 2 6 A 7 M	

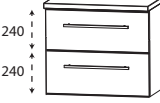

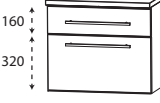
Please observe suitable accessories in the separate index.

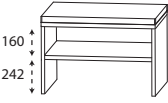
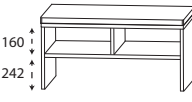
Program 026 - model list

Depth indication corresponds to the carcass depth		Depth in mm	Width in mm	Height in mm	Article number	Hinge
Base units						
	Base unit 2 pull-outs with buffered closing 1 top cover 330 mm deep	300	300	508	UNA 3 6 3 A 7	
		300	400	508	UNA 3 6 4 A 7	
	Base unit 2 pull-outs with buffered closing 1 top cover 330 mm deep	300	600	508	UNA 3 6 6 A 7	
	Base unit 1 drawer with buffered closing 1 metal pull-out with buffered closing, 1 top cover 330 mm deep	300	300	508	UNA 3 4 3 A 7 M	
		300	400	508	UNA 3 4 4 A 7 M	
	Base unit 1 drawer with buffered closing 1 metal pull-out with buffered closing, 1 top cover 330 mm deep	300	600	508	UNA 3 4 6 A 7 M	
	Base unit 1 flap door, 1 top cover 260 mm deep	230	600	348	UMA 2 1 6 A 7 K	
Benches						
	Bench 1 shelf 1 seat cushion in imitation leather Colour version corresponds to the carcass colour					
		cushion in creamy-white	450	600	508	SETBANK 6 W
	cushion in black	450	600	508	SETBANK 6 S	
	Bench 2 shelves 1 seat cushion in imitation leather Colour version corresponds to the carcass colour					
		cushion in creamy-white	450	900	508	SETBANK 9 W
	cushion in black	450	900	508	SETBANK 9 S	

Please observe suitable accessories in the separate index.

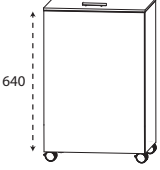
Program 026 - model list

Depth indication corresponds to the carcass depth	Depth in mm	Width in mm	Height in mm	Article number	Hinge
<h2>Laundryrolli</h2>					
 <p>Laundryrolli 1 flap door, with buffered closing 1 take-out laundry-bag, washable 4 roles Colour version corresponds to the carcass colour incl. height indication rolls (100 mm)</p>	470	470	756	WRS 4 0 4 7	
<h2>Glass shelves</h2>					
 <p>Glass shelf incl. metal holder</p> <p>400 mm wide incl. 2 metal brackets</p> <p>600 mm wide incl. 2 metal brackets</p> <p>900 mm wide incl. 3 metal brackets</p> <p>1200 mm wide incl. 3 metal brackets</p> <p>1400 mm wide incl. 4 metal brackets</p>	130	400	8	ABG 1 3 4 0 0 8	
	130	600	8	ABG 1 3 6 0 0 8	
	130	900	8	ABG 1 3 9 0 0 8	
	130	1200	8	ABG 1 3 1 2 0 8	
	130	1400	8	ABG 1 3 1 4 0 8	
<h2>Push- fit shelf</h2>					
 <p>Push-fit shelf with ABS thick edge all around incl. holders for push fit shelf</p> <p>300 mm wide incl. 2 push-fit holder</p> <p>400 mm wide incl. 2 push-fit holder</p> <p>600 mm wide incl. 2 push-fit holder</p> <p>900 mm wide incl. 3 push-fit holder</p> <p>1200 mm wide incl. 3 push-fit holder</p> <p>1400 mm wide incl. 3 push-fit holder</p>	150	300	28	SBG 6 0 3 0	
	150	400	28	SBG 6 0 4 0	
	150	600	28	SBG 6 0 6 0	
	150	900	28	SBG 6 0 9 0	
	150	1200	28	SBG 6 0 1 2	
	150	1400	28	SBG 6 0 1 4	

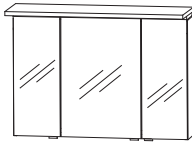
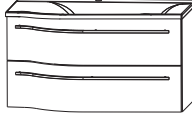

Please observe suitable accessories in the separate index.

Program 026 - bathroom versions

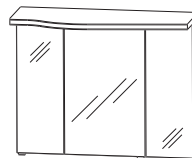
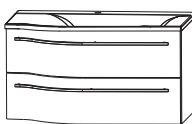

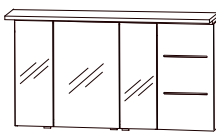
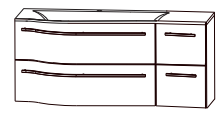

SWM-E190-2R			
1	Mirror cabinet, series A	S E T 4 3 9 0 2	
1	Washbasin base unit	W U A 3 6 9 0 1 M	
1	evermite washbasin, 900 mm	W M M 5 2 9 R 2 1	
S W G 8 2 9 0 2 R		WGM 509R 82 glass optiwhite inst. cast mineral	
S W G 9 2 9 0 2 R		WGM 509R 92 glass optiwhite matt inst. cast mineral	
			900 mm wide

SWM-E190-3R			
1	Mirror cabinet, series B	S E T 4 3 9 0 3	
1	Washbasin base unit	W U A 3 6 9 0 1 M	
1	evermite washbasin, 900 mm	W M M 5 2 9 R 2 1	
S W G 8 2 9 0 3 R		WGM 509R 82 glass optiwhite inst. cast mineral	
S W G 9 2 9 0 3 R		WGM 509R 92 glass optiwhite matt inst. cast mineral	
			900 mm wide

SWM-E112-2R			
1	Mirror cabinet, series A	S E T 4 0 1 2 2 R	
1	washbasin base unit 900 mm	W U A 3 6 9 0 1 M	
1	washbasin base unit 300 mm	U T A 3 6 3 0 1 M	
1	evermite washbasin, 1200 mm	W M M 5 2 2 R 2 1	
S W G 8 2 1 2 2 R		WGM 512R 82 glass optiwhite inst. cast mineral	
S W G 9 2 1 2 2 R		WGM 512R 92 glass optiwhite matt inst. cast mineral	
			1200 mm wide

SWM-E112-3R			
1	Mirror cabinet, series A	S E T 4 1 1 2 2 R	
1	washbasin base unit 900 mm	W U A 3 6 9 0 1 M	
1	washbasin base unit 300 mm	U T A 3 6 3 0 1 M	
1	evermite washbasin, 1200 mm	W M M 5 2 2 R 2 1	
S W G 8 2 1 2 3 R		WGM 512R 82 glass optiwhite inst. cast mineral	
S W G 9 2 1 2 3 R		WGM 512R 92 glass optiwhite matt inst. cast mineral	
			1200 mm wide

Program 026 - bathroom versions

SWM-E112-4R		
1	Mirror cabinet, series B	
1	washbasin base unit 900 mm	W U A 3 6 9 0 1 M
1	washbasin base unit 300 mm	U T A 3 6 3 0 1 M
1	evermite washbasin, 1200 mm	W M M 5 2 2 R 2 1
S W G 8 2 1 2 4 R		WGM 512R 82 glass optiwhite inst. cast mineral
S W G 9 2 1 2 4 R		WGM 512R 92 glass optiwhite matt inst. cast mineral
		1200 mm wide
SWM-E112-5R		
1	Mirror cabinet, series B	
1	washbasin base unit 900 mm	W U A 3 6 9 0 1 M
1	washbasin base unit 300 mm	U T A 3 6 3 0 1 M
1	evermite washbasin, 1200 mm	W M M 5 2 2 R 2 1
S W G 8 2 1 2 5 R		WGM 512R 82 glass optiwhite inst. cast mineral
S W G 9 2 1 2 5 R		WGM 512R 92 glass optiwhite matt inst. cast mineral
		1200 mm wide
SWM-E114-2R		
1	Mirror cabinet, series A	
1	washbasin base unit 900 mm	W U A 3 6 9 0 1 M
1	washbasin base unit 500 mm	U T A 3 6 5 0 1 M
1	evermite washbasin, 1400 mm	W M M 5 2 4 R 2 1
S W G 8 2 1 4 2 R		WGM 514 82 glass optiwhite inst. cast mineral
S W G 9 2 1 4 2 R		WGM 514R 92 glass optiwhite matt inst. cast mineral
		1400 mm wide
SWM-E114-3R		
1	Mirror cabinet, series A	
1	washbasin base unit 900 mm	W U A 3 6 9 0 1 M
1	washbasin base unit 500 mm	U T A 3 6 5 0 1 M
1	evermite washbasin, 1400 mm	W M M 5 2 4 R 2 1
S W G 8 2 1 4 3 R		WGM 514R 82 glass optiwhite inst. cast mineral
S W G 9 2 1 4 3 R		WGM 514R 92 glass optiwhite matt inst. cast mineral
		1400 mm wide

Program 026 - bathroom versions

SWM-E114-4R

1	Mirror cabinet, series B	S E T 4 0 1 4 3 R
1	washbasin base unit 900 mm	W U A 3 6 9 0 1 M
1	washbasin base unit 500 mm	U T A 3 6 5 0 1 M
1	evermite washbasin, 1400 mm	W M M 5 2 4 R 2 1

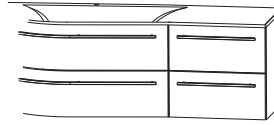
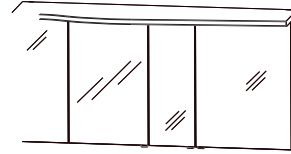

1400 mm wide

S W G 8 2 1 4 4 R WGM 514R 82 glass optiwhite inst. cast mineral

S W G 9 2 1 4 4 R WGM 514R 92 glass optiwhite matt inst. cast mineral

SWM-E114-5R

1	Mirror cabinet, series B	S E T 4 1 1 4 3 R
1	washbasin base unit 900 mm	W U A 3 6 9 0 1 M
1	washbasin base unit 500 mm	U T A 3 6 5 0 1 M
1	evermite washbasin, 1400 mm	W M M 5 2 4 R 2 1

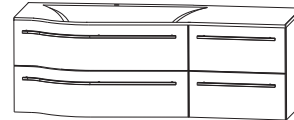
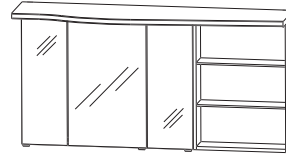

1400 mm wide

S W G 8 2 1 4 5 R WGM 514R 82 glass optiwhite inst. cast mineral

S W G 9 2 1 4 5 R WGM 514R 92 glass optiwhite matt inst. cast mineral

SWM-E118-2

1	Mirror cabinet, series A	S E T 4 0 1 8 2
1	washbasin base unit 900 mm	W U A 3 6 9 0 1 M
1	washbasin base unit 900 mm	W U A 3 6 9 0 1 M
1	evermite washbasin, 1800 mm Double washbasin	W M M 5 2 8 D 2 1

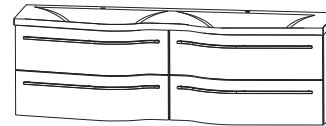
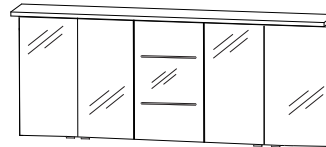

1800 mm wide

S W G 8 2 1 8 2 WGM 518D 82 glass optiwhite inst. cast mineral

S W G 9 2 1 8 2 WGM 518D 92 glass optiwhite matt inst. cast mineral

SWM-E118-3

1	Mirror cabinet, series A	S E T 4 1 1 8 2
1	washbasin base unit 900 mm	W U A 3 6 9 0 1 M
1	washbasin base unit 900 mm	W U A 3 6 9 0 1 M
1	evermite washbasin, 1800 mm Double washbasin	W M M 5 2 8 D 2 1

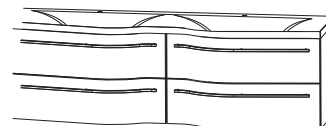
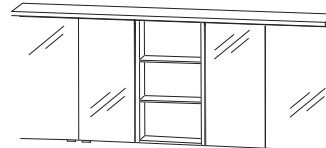



1800 mm wide

S W G 8 2 1 8 3 WGM 518D 82 glass optiwhite inst. cast mineral

S W G 9 2 1 8 3 WGM 518D 92 glass optiwhite matt inst. cast mineral

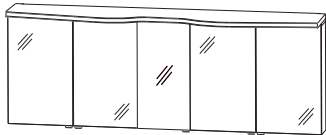
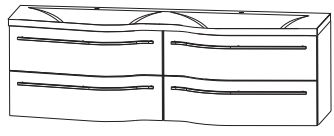
Program 026 - bathroom versions

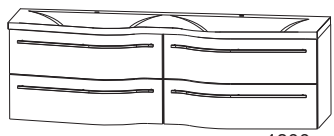
SWM-E118-4			
1	Mirror cabinet, series B	S E T 4 0 1 8 3	
1	washbasin base unit 900 mm	W U A 3 6 9 0 1 M	
1	washbasin base unit 900 mm	W U A 3 6 9 0 1 M	
1	evermite washbasin, 1800 mm Double washbasin	W M M 5 2 8 D 2 1	
S W G 8 2 1 8 4		WGM 518D 82 glass optiwhite inst. cast mineral	 <p style="text-align: right;">1800 mm wide</p>
S W G 9 2 1 8 4		WGM 518D 92 glass optiwhite matt inst. cast mineral	
SWM-E118-5			
1	Mirror cabinet, series B	S E T 4 1 1 8 3	
1	washbasin base unit 900 mm	W U A 3 6 9 0 1 M	
1	washbasin base unit 900 mm	W U A 3 6 9 0 1 M	
1	evermite washbasin, 1800 mm Double washbasin	W M M 5 2 8 D 2 1	
S W G 8 2 1 8 5		WGM 518D 82 glass optiwhite inst. cast mineral	 <p style="text-align: right;">1800 mm wide</p>
S W G 9 2 1 8 5		WGM 518D 92 glass optiwhite matt inst. cast mineral	

Program 026 - dimensional drawings

WGM 509R

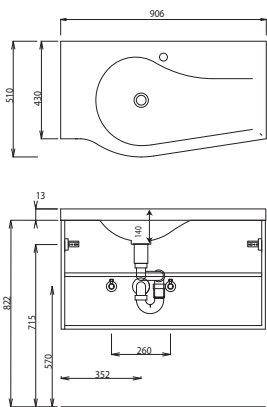

WGM 509L

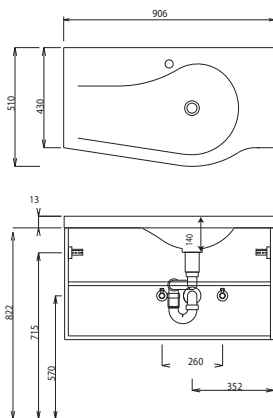

WGM 512R

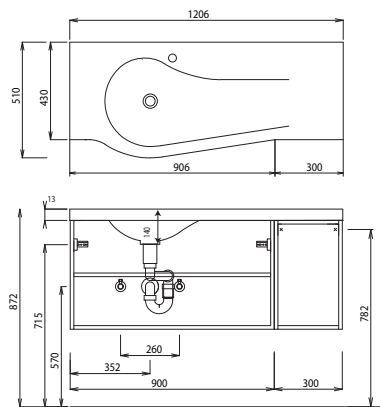

WGM 512L

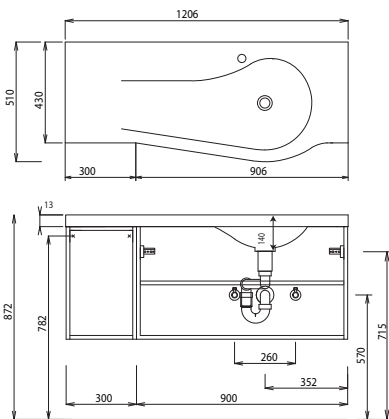

WGM 514R

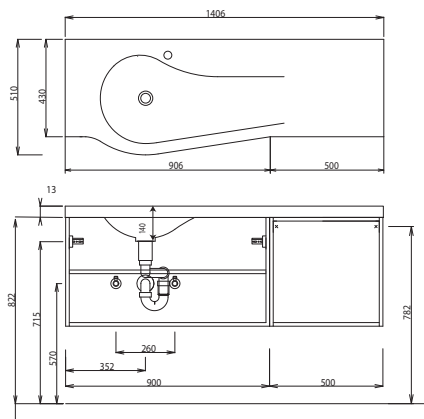

WGM 514L

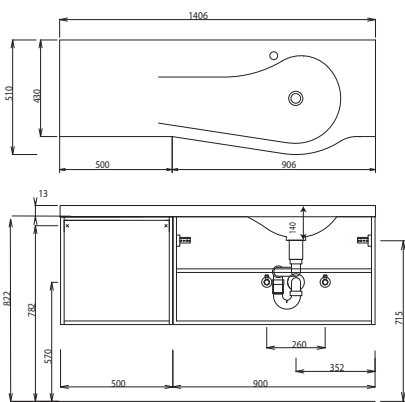

WGM 518

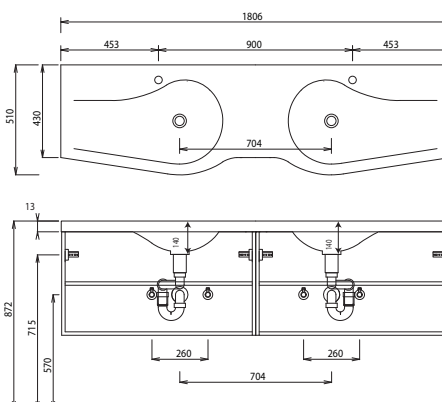

For washing stands with fixing screws, the dimensions for boring must be drawn in on-site after the washing stand has been laid on the floor unit.

Washing stands without anchoring brackets have to be fixed on the wall and on the furniture-side with silicon! Cast mineral: The water temperature must not exceed 55° C / 131° F. Hair tinting lotions have to be removed immediately, so that staining can be avoided.

Modifications:

Technical modifications (+/- 5mm) and flatness modifications (DIN 18202) are subject of the usual material-specific modifications for construction materials, based on DIN 18202.

Program 026 - dimensional drawings

WMM 529L

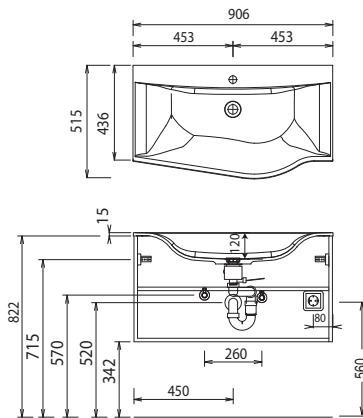

WMM 529R

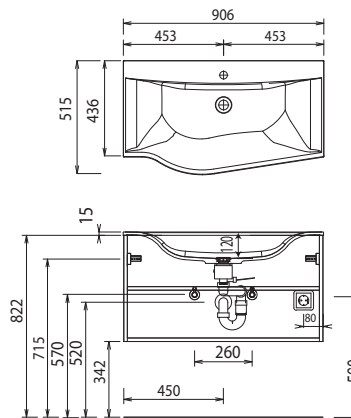

WMM 522L

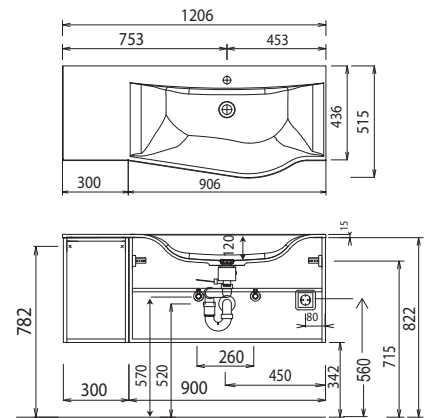

WMM 522R

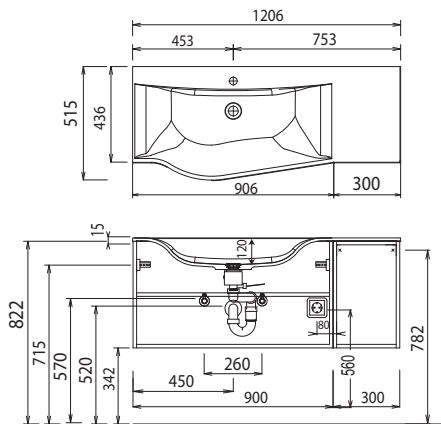

WMM 524L

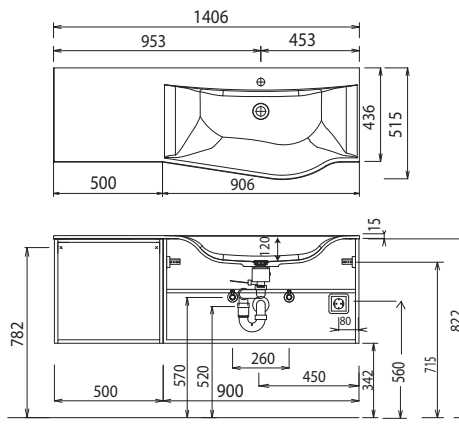

WMM 524R

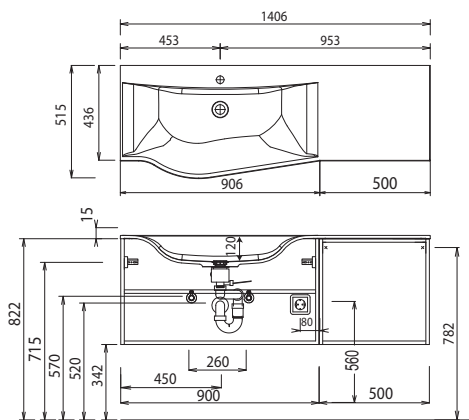

WMM 528D

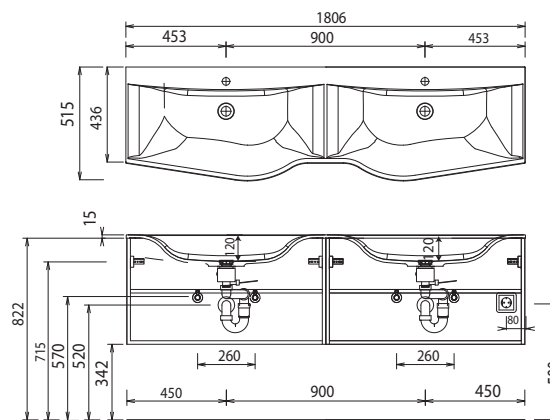

For washing stands with fixing screws, the dimensions for boring must be drawn in on-site after the washing stand has been laid on the floor unit.

Washing stands without anchoring brackets have to be fixed on the wall and on the furniture-side with silicon! Cast mineral: The water temperature must not exceed 55° C / 131° F. Hair tinting lotions have to be removed immediately, so that staining can be avoided.

Modifications:

Technical modifications (+/- 5mm) and flatness modifications (DIN 18202) are subject of the usual material-specific modifications for construction materials, based on DIN 18202.

Program 026 - dimensional drawings

electrical connections for mirror cabinets

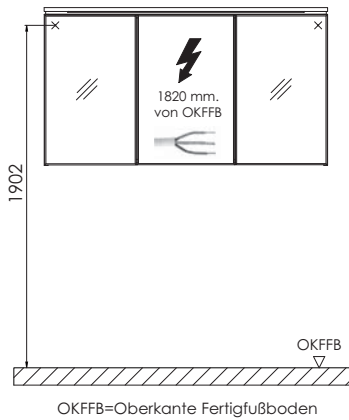

For washing stands with fixing screws, the dimensions for boring must be drawn in on-site after the washing stand has been laid on the floor unit.

Washing stands without anchoring brackets have to be fixed on the wall and on the furniture-side with silicon! Cast mineral: The water temperature must not exceed 55° C / 131° F. Hair tinting lotions have to be removed immediately, so that staining can be avoided.

Modifications:

Technical modifications (+/- 5mm) and flatness modifications (DIN 18202) are subject of the usual material-specific modifications for construction materials, based on DIN 18202.