



Front colours



no. 794 sand oak



No. 894 glass Optiwhite matt
outer edges in sand oak



No. 895 glass grey matt
outer edges in sand oak

F foiled front

G glass front

carcass colours



Carrier material in
no. 194
sand oak

Visible side
No. 007 glass
Optiwhite matt



Carrier material in
no. 194
sand oak

Visible side colours
No. 310 glass
grey matt

Handle and technique versions



Push to open

No. 558
Premium - Push to open Silent
No. 005



No. 329
Strip handle chrome



no. 338
Strip handle aluminium
matt



No. 339
Strip handle black matt

Washbasin colours

STONEPLUS washbasins

Glass washbasin



No. 61
white **STONEPLUS**

New, harder, easy-care
surface.

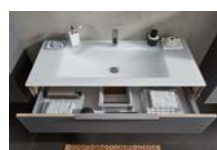

no. 82
optiwhite



no. 92
optiwhite matt











No. 554
Pull out with premium soft
No. 003
door with integrated buffered
closing

handle length 294 mm / 494
mm

Illustrations and specifications are without obligation. Technical modifications reserved.
2021/2022



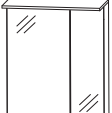



Please note the instruction for warranty, mounting and care, and the quality agreements as well, at the beginning of the book.

Program 056 - type list

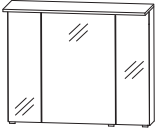
Depth indication corresponds to the carcass depth		Depth in mm	Width in mm	Height in mm	Article number	Hinge
Mirrors						
  	<p>mirror, 600 mm LED- lighting (18,6 W.) at top and bottom with mirror heating 15 watt inkl. converter 60 Watt / 24 V. Emotion lighting 1 sensor for mirror heating This product contains a light source with energy efficiency class: F</p>	33	600	672	F S A 4 3 6 0 8 9	
  	<p>Mirror, 900 mm LED- lighting (27,9 W.) at top and bottom with mirror heating 15 watt inkl. converter 60 Watt / 24 V. Emotion lighting 1 sensor for mirror heating This product contains a light source with energy efficiency class: F</p>	33	900	672	F S A 4 3 9 0 8 9	
  	<p>Mirror, 1200 mm LED- lighting (37,2 W.) at top and bottom with mirror heating 15 watt inkl. converter 60 Watt / 24 V. Emotion lighting This product contains a light source with energy efficiency class: F 1 sensor for mirror heating</p>	33	1200	672	F S A 4 3 1 2 8 9	
Mirror cabinets						
  	<p>Mirror cabinet, 600 mm 2 mirror doors on wooden-plated 1 central partition 4 glass shelves 1 LED panel light (8,5 watt) 1 LED converter 12 V, 15 watt large door with mirror heating 15 watt inkl. converter 15 Watt / 24 V. Emotion lighting 1 switch socket element Door width: 396 mm / 196 mm This product contains a light source with energy efficiency class: F</p>	150	600	650	S 2 A 4 3 6 L 8 9	
	<p>Mirror cabinet, 600 mm Description as above, though without mirror heating and converter 24 volt</p> <p>Additional accessories LED washbasin lighting LED washbasin lighting emotion</p>	150	600	650	S 2 A 4 3 6 L 9 1 P Z 1 0 6 3 60 P Z 1 1 5 0 60	

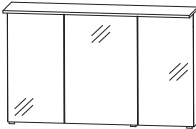



Please observe suitable accessories in the separate index.

Program 056 - type list

		Depth in mm	Width in mm	Height in mm	Article number	Hinge
Depth indication corresponds to the carcass depth						
Mirror cabinets						
  	Mirror cabinet, 900 mm 3 mirror doors on wooden-plated 6 glass shelves 2 central partitions, 1 LED panel light (13,2 watt) 1 LED converter 12 V, 30 watt central door with mirror heating 15 watt inkl. converter 15 Watt / 24 V. Emotion lighting 1 switch socket element Door width: 238 mm / 412 mm / 238 mm This product contains a light source with energy efficiency class: F	150	900	650	S 2 A 4 3 9 A 8 9	
	Mirror cabinet, 900 mm Description as above, though without mirror heating and converter 24 volt Additional accessories LED washbasin lighting LED washbasin lighting emotion	150	900	650	S 2 A 4 3 9 A 9 1 P Z 1 0 6 3 9 0 P Z 1 1 5 0 9 0	
  	Mirror cabinet, 1200 mm 3 mirror doors on wooden-plated 2 central partitions, 6 glass shelves 1 LED panel light (17,8 watt) 1 LED converter 12 V, 30 watt central door with mirror heating 15 watt inkl. converter 15 Watt / 24 V. Emotion lighting 1 switch socket element Door width: 388 mm / 412 mm / 388 mm This product contains a light source with energy efficiency class: F	150	1200	650	S 2 A 4 3 1 A 8 9	
	Mirror cabinet, 1200 mm Description as above, though without mirror heating and converter 24 volt Additional accessories LED washbasin lighting LED washbasin lighting emotion	150	1200	650	S 2 A 4 3 1 A 9 1 P Z 1 0 6 3 1 2 P Z 1 1 5 0 1 2	
STONEPLUS washbasins						
	STONEPLUS washbasin, 600 mm colour white inkl. concealed overflow system chrome finish can be combined with WUA 3360 23, WUA 3360 30 Additional accessories Additional price for Washbasin without tap hole / with 3 holes (acc. to sketch).	500	620	15	W M S 5 0 6 0 6 1	









*Delivery time: 8 weeks. Price per washbasin. Washbasin without tap hole is incompatible with CLOU System. Please check your order confirmation for correctness.

Program 056 - type list

Depth indication corresponds to the carcass depth		Depth in mm	Width in mm	Height in mm	Article number	Hinge
STONEPLUS washbasins						
	STONEPLUS washbasin, 900 mm colour white inkl. concealed overflow system chrome finish can be combined with WUA 3390 23, WUA 3390 30 Additional accessories Additional price for Washbasin without tap hole / with 3 holes (acc. to sketch).	500	920	15	WMS 5 0 9 0 6 1	
	STONEPLUS washbasin, 1.200 mm colour white inkl. concealed overflow system chrome finish can be combined with WUA 3312 23, WUA 3312 30 Additional accessories Additional price for Washbasin without tap hole / with 3 holes (acc. to sketch).	500	1220	15	WMS 5 1 2 0 6 1	
	STONEPLUS double washbasin, 1200 mm, colour white inkl. 2 concealed overflow systems chrome finish can be combined with WUA 332D 23, WUA 332D 30 Additional accessories Additional price for Washbasin without tap hole / with 3 holes (acc. to sketch).	500	1220	15	WMS 7 1 2 0 6 1	
Glass washbasin						
	Glass washbasin, 600 mm inkl. concealed overflow system chrome finish Colour Optiwhite Colour Optiwhite matt can be combined with WUA 3360 23, WUA 3360 30 Additional accessories Neutrally bonding silicone for glass washbasins Surcharge for washbasins without tap-hole or with 3 holes (according to sketch)	500 500	620 620	12 12	SWG 5 0 6 0 8 2 SWG 5 0 6 0 9 2	P Z 1 2 3 5
	Glass washbasin, 900 mm inkl. concealed overflow system chrome finish Colour Optiwhite Colour Optiwhite matt can be combined with WUA 3390 23, WUA 3390 30 Additional accessories Neutrally bonding silicone for glass washbasins Surcharge for washbasins without tap-hole or with 3 holes (according to sketch)	500 500	920 920	12 12	SWG 5 0 9 0 8 2 SWG 5 0 9 0 9 2	P Z 1 2 3 5

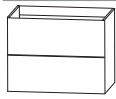
*Delivery time: 8 weeks. Price per washbasin. Washbasin without tap hole is incompatible with CLOU System. Please check your order confirmation for correctness.

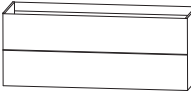
Program 056 - type list







Depth indication corresponds to the carcass depth		Depth in mm	Width in mm	Height in mm	Article number	Hinge
Glass washbasin						
	Glass washbasin, 1200 mm inkl. concealed overflow system chrome finish					
	Colour Optiwhite	500	1220	12	SWG 5 1 2 0 8 2	
	Colour Optiwhite matt	500	1220	12	SWG 5 1 2 0 9 2	
	can be combined with WUA 3312 23, WUA 3312 30					
	Additional accessories Neutrally bonding silicone for glass washbasins Surcharge for washbasins without tap-hole or with 3 holes (according to sketch)				P Z 1 2 3 5	
	Glass double washbasin, 1200 mm inkl. 2 concealed overflow systems chrome finish					
	Colour Optiwhite	500	1220	12	SWG 7 1 2 0 8 2	
	Colour Optiwhite matt	500	1220	12	SWG 7 1 2 0 9 2	
	can be combined with WUA 332D 23, WUA 332D 30					
	Additional accessories Neutrally bonding silicone for glass washbasins Surcharge for washbasins without tap-hole or with 3 holes (according to sketch)				P Z 1 2 3 5	
Washbasin base units handleless / Push to open						
	Washbasin base unit 600 mm 1 metal pull out unit with buffered closing 1 metal pull-out with buffered closing incl. drawer rail	470	600	480	WUA 3 3 6 0 2 3	
	Additional accessories Space-saving drain stench trap DN 40 Space-saving drain stench trap DN 32				P Z 1 3 6 7 P Z 1 4 2 3	
	washbasin base unit 900 mm 1 metal pull out unit with buffered closing 1 metal pull-out with buffered closing incl. drawer rail	470	900	480	WUA 3 3 9 0 2 3	
	Additional accessories Space-saving drain stench trap DN 40 Space-saving drain stench trap DN 32				P Z 1 3 6 7 P Z 1 4 2 3	
	washbasin base unit 1200 mm for single washbasin solution 1 metal pull out unit with buffered closing 1 metal pull-out with buffered closing incl. drawer rail	470	1200	480	WUA 3 3 1 2 2 3	
	Additional accessories Space-saving drain stench trap DN 40 Space-saving drain stench trap DN 32				P Z 1 3 6 7 P Z 1 4 2 3	

*Delivery time: 8 weeks. Price per washbasin. Washbasin without tap hole is incompatible with CLOU System. Please check your order confirmation for correctness.

Program 056 - type list

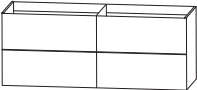
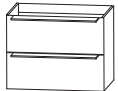

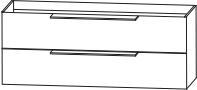

Depth indication corresponds to the carcass depth

Washbasin base units handleless / Push to open

	Depth in mm	Width in mm	Height in mm	Article number	Hinge
 <p>washbasin base unit 1200 mm for double washbasin solutions 1 metal pull out unit with buffered closing 1 metal pull-out with buffered closing incl. drawer rail</p>  <p>Additional accessories Space-saving drain stench trap DN 40 (order 2 pieces) Space-saving drain stench trap DN 32 (order 2 pieces)</p>	470	1200	480	W U A 3 3 2 D 2 4 P Z 1 3 6 7 P Z 1 4 2 3	
 <p>washbasin base unit 1200 mm for double washbasin solutions 2 metal pull out units with buffered closing and syphon cut-out 2 metal pull outs with buffered closing and rail</p> <p>Additional accessories Space-saving drain stench trap DN 40 (order 2 pieces) Space-saving drain stench trap DN 32 (order 2 pieces)</p>	470	1200	480	W U A 3 3 2 D 2 3 P Z 1 3 6 7 P Z 1 4 2 3	
<h2>Washbasin base units with handles / without Push to open</h2>					
 <p>Washbasin base unit 600 mm 1 metal pull out unit with buffered closing 1 metal pull-out with buffered closing incl. drawer rail</p> <p>Additional accessories Space-saving drain stench trap DN 40 Space-saving drain stench trap DN 32</p>	470	600	480	W U A 3 3 6 0 3 0 P Z 1 3 6 7 P Z 1 4 2 3	
 <p>washbasin base unit 900 mm 1 metal pull out unit with buffered closing 1 metal pull-out with buffered closing incl. drawer rail</p> <p>Additional accessories Space-saving drain stench trap DN 40 Space-saving drain stench trap DN 32</p>	470	900	480	W U A 3 3 9 0 3 0 P Z 1 3 6 7 P Z 1 4 2 3	
 <p>washbasin base unit 1200 mm for single washbasin solution 1 metal pull out unit with buffered closing 1 metal pull-out with buffered closing incl. drawer rail</p>  <p>Additional accessories Space-saving drain stench trap DN 40 Space-saving drain stench trap DN 32</p>	470	1200	480	W U A 3 3 1 2 3 0 P Z 1 3 6 7 P Z 1 4 2 3	

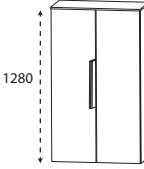

Please observe suitable accessories in the separate index.

Program 056 - type list

Depth indication corresponds to the carcass depth		Depth in mm	Width in mm	Height in mm	Article number	Hinge
<h3>Washbasin base units with handles / without Push to open</h3>						
	washbasin base unit 1200 mm for double washbasin solutions 1 metal pull out unit with buffered closing 1 metal pull-out with buffered closing incl. drawer rail	470	1200	480	W U A 3 3 1 2 3 D	
	Additional accessories Space-saving drain stench trap DN 40 (order 2 pieces) Space-saving drain stench trap DN 32 (order 2 pieces)				P Z 1 3 6 7 P Z 1 4 2 3	
	washbasin base unit 1200 mm for double washbasin solutions 2 metal pull out units with buffered closing and syphon cut-out 2 metal pull outs with buffered closing and rail	470	1200	480	W U A 3 3 2 D 3 0	
	Additional accessories Space-saving drain stench trap DN 40 (order 2 pieces) Space-saving drain stench trap DN 32 (order 2 pieces)				P Z 1 3 6 7 P Z 1 4 2 3	
<h3>Central units</h3>						
	medium-high unit 1 door 4 glass shelves 1 glass top cover 326 mm deep	300	308	1286	M N A 8 1 3 A 3	L/R
III. with handles						
	medium-high unit 2 doors 4 glass shelves 1 glass top cover 326 mm deep	300	608	1286	M N A 8 1 6 A 3	
III. with handles						

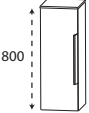
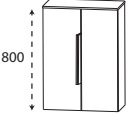
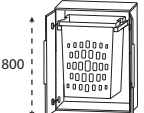

Please observe suitable accessories in the separate index.

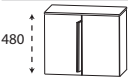
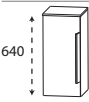
Program 056 - type list

Depth indication corresponds to the carcass depth		Depth in mm	Width in mm	Height in mm	Article number			Hinge					
Highboards													
 800 III. with handles	Highboard 1 door 2 glass shelves 1 glass top cover 326 mm deep	300	308	806	H	B	A	5	1	3	A	3	L/R
 800 III. with handles	Highboard 2 doors 2 glass shelves 1 glass top cover 326 mm deep	300	608	806	H	B	A	5	1	6	A	3	
 800 III. with handles	Highboard with laundry pull out 2 doors 1 laundry pull out Volume of laundry pull out: 40 liters 1 glass top cover 326 mm deep	300	608	806	H	B	A	5	1	6	W	A	3
Base units													
 480 III. with handles	Base unit 1 door 1 glass shelf 1 glass top cover 326 mm deep	300	308	486	U	N	A	3	1	3	A	3	L/R
 480 III. with handles	Base unit 2 doors 1 glass shelf 1 glass top cover 326 mm deep	300	608	486	U	N	A	3	1	6	A	3	
Wall units													
 640 III. with handles	Wall unit 1 door 1 glass shelf 1 glass top cover 176 mm deep	150	308	646	O	G	A	4	1	3	A	3	L/R

Please observe suitable accessories in the separate index.

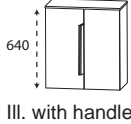
Program 057 - type list

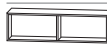
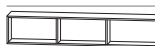

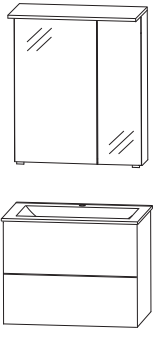
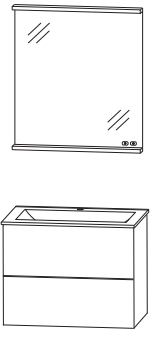
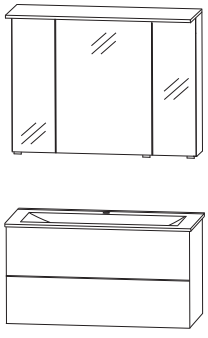
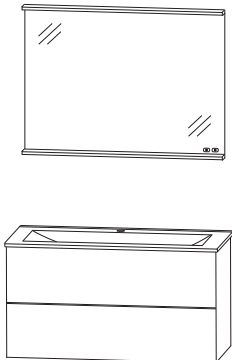

Depth indication corresponds to the carcass depth		Depth in mm	Width in mm	Height in mm	Article number	Hinge
<h3>Wall units</h3>  <p>Wall unit 2 doors 1 glass shelf 1 glass top cover 176 mm deep</p>		150	608	646	O G A 4 1 6 A 3	
<h3>Glass shelves</h3>  <p>Glass shelf incl. metal holder</p> <p>600 mm wide incl. 2 metal brackets</p> <p>900 mm wide incl. 3 metal brackets</p> <p>1200 mm wide incl. 3 metal brackets</p>						
		130	600	8	A B G 1 3 6 0 0 8	
		130	900	8	A B G 1 3 9 0 0 8	
		130	1200	8	A B G 1 3 1 2 0 8	
<h3>Shelves</h3>						
	<p>functional shelf Edges are cut with a mitre vertical and horizontal mounting possible</p> <p>please indicate colour version: no. 501 white matt lacquered no. 547 black matt lacquered</p>	150	300	160	R G L 1 1 3 0 0 1	
	<p>functional shelf Edges are cut with a mitre vertical and horizontal mounting possible</p> <p>please indicate colour version: no. 501 white matt lacquered no. 547 black matt lacquered</p>	150	600	160	R G L 1 1 6 0 0 2	
	<p>functional shelf Edges are cut with a mitre vertical and horizontal mounting possible</p> <p>please indicate colour version: no. 501 white matt lacquered no. 547 black matt lacquered</p>	150	900	160	R G L 1 1 9 0 0 3	

Please observe suitable accessories in the separate index.

Program 056 - examples

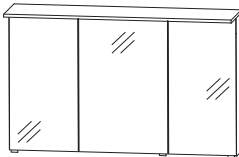
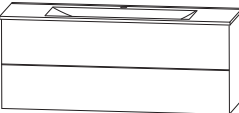
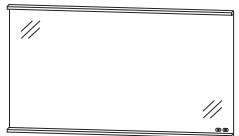
ILS-0160-1			 <p style="text-align: right;">600 mm wide</p>
1	Mirror cabinet, 600 mm	S 2 A 4 3 6 L 8 9	
1	Washbasin base unit	W U A 3 3 6 0 2 3	
1	STONEPLUS washbasin, 600 mm	W M S 5 0 6 0 6 1	
		Sum	
IL G 8 2 6 0 1	SWG 5060 82 glass optiwhite inst. Stoneplus	Sum	
IL G 9 2 6 0 1	SWG 5060 92 glass optiwhite matt inst. cast mineral	Sum	
ILS-0160-2			 <p style="text-align: right;">600 mm wide</p>
1	Mirror 600 mm	F S A 4 3 6 0 8 9	
1	Washbasin base unit	W U A 3 3 6 0 2 3	
1	STONEPLUS washbasin, 600 mm	W M S 5 0 6 0 6 1	
		Sum	
IL G 8 2 6 0 2	SWG 5060 82 glass optiwhite inst. cast mineral	Sum	
IL G 9 2 6 0 2	SWG 5060 92 glass optiwhite matt inst. cast mineral	Sum	
ILS-0190-1			 <p style="text-align: right;">900 mm wide</p>
1	Mirror cabinet, 900 mm	S 2 A 4 3 9 A 8 9	
1	Washbasin base unit	W U A 3 3 9 0 2 3	
1	STONEPLUS washbasin, 900 mm	W M S 5 0 9 0 6 1	
		Sum	
IL G 8 2 9 0 1	SWG 5090 82 glass optiwhite inst. cast mineral	Sum	
IL G 9 2 9 0 1	SWG 5090 92 glass optiwhite matt inst. cast mineral	Sum	
ILS-0190-2			 <p style="text-align: right;">900 mm wide</p>
1	Mirror 900 mm	F S A 4 3 9 0 8 9	
1	Washbasin base unit	W U A 3 3 9 0 2 3	
1	STONEPLUS washbasin, 900 mm	W M S 5 0 9 0 6 1	
		Sum	
IL G 8 2 9 0 2	SWG 5090 82 glass optiwhite inst. cast mineral	Sum	
IL G 9 2 9 0 2	SWG 5090 92 glass optiwhite matt inst. cast mineral	Sum	

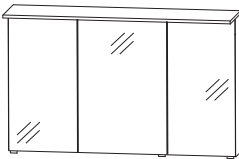
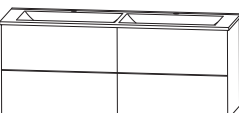
Program 056 - examples

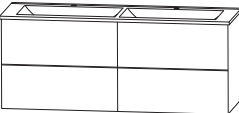
ILS-0112-1			  1200 mm wide
1	Mirror cabinet 1200 mm	S 2 A 4 3 1 A 8 9	
1	Washbasin base unit	W U A 3 3 1 2 2 3	
1	STONEPLUS washbasin, 1.200 mm	W M S 5 1 2 0 6 1	
		Sum	
IL G 8 2 1 2 1	SWG 5120 82 glass optiwhite inst. cast mineral	Sum	
IL G 9 2 1 2 1	SWG 5120 92 glass optiwhite matt inst. cast mineral	Sum	
ILS-0112-2			  1200 mm wide
1	Mirror 1200 mm	F S A 4 3 1 2 8 9	
1	Washbasin base unit	W U A 3 3 1 2 2 3	
1	STONEPLUS washbasin, 1.200 mm	W M S 5 1 2 0 6 1	
		Sum	
IL G 8 2 1 2 2	SWG 5120 82 glass optiwhite inst. cast mineral	Sum	
IL G 9 2 1 2 2	SWG 5120 92 glass optiwhite matt inst. cast mineral	Sum	
ILS-0112-1D			  1200 mm wide
1	Mirror cabinet 1200 mm	S 2 A 4 3 1 A 8 9	
1	Washbasin base unit	W U A 3 3 2 D 2 3	
1	STONEPLUS washbasin, 1.200 mm Double washbasin	W M S 7 1 2 0 6 1	
		Sum	
IL G 8 2 1 2 1 D	SWG 7120 82 glass optiwhite inst. cast mineral	Sum	
IL G 9 2 1 2 1 D	SWG 7120 92 glass optiwhite matt inst. cast mineral	Sum	
ILS-0112-2D			  1200 mm wide
1	Mirror 1200 mm	F S A 4 3 1 2 8 9	
1	Washbasin base unit	W U A 3 3 2 D 2 3	
1	STONEPLUS washbasin, 1.200 mm Double washbasin	W M S 7 1 2 0 6 1	
		Sum	
IL G 8 2 1 2 2 D	SWG 7120 82 glass optiwhite inst. cast mineral	Sum	
IL G 9 2 1 2 2 D	SWG 7120 92 glass optiwhite matt inst. cast mineral	Sum	

Program 056 - dimensional drawings

WMS / SWG 5060

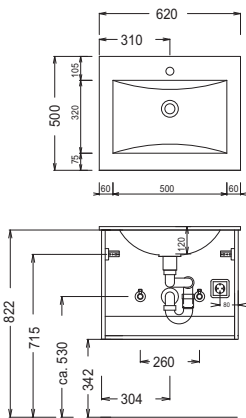

WMS / SWG 5090

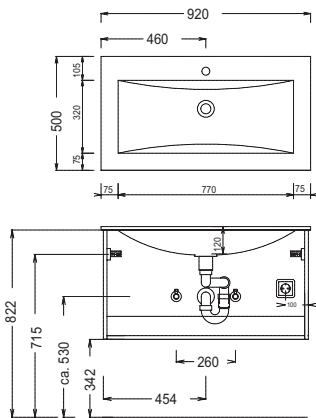

WMS / SWG 5120

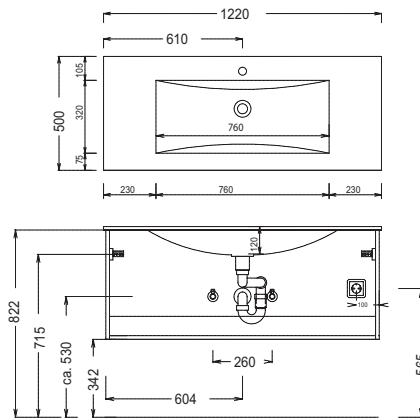

WMS / SWG 7120

electrical connections for mirror cabinets

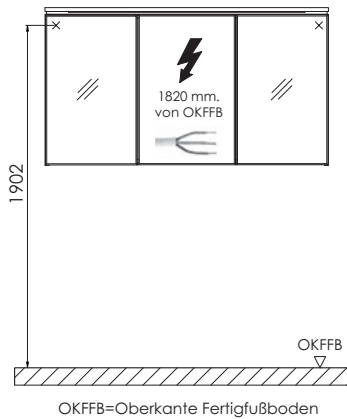
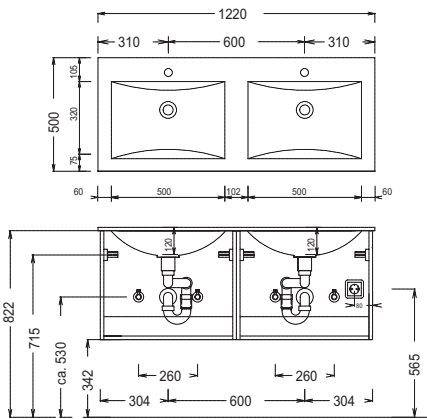

STONEPLUS:

The water temperature must not exceed 55° C / 131° F. Hair tinting lotions have to be removed in a few seconds, so that staining can be avoided.

Modifications:

Technical modifications (+/- 5mm) and flatness modifications (DIN 18202) are subject of the usual material-specific modifications for construction materials, based on DIN 18202.