



## Front colours



No. 764 Stonegrey matt



No. 777 cosmos grey matt



No. 793 noble white matt



No. 891 quarz grey matt



No. 893 titanium grey matt

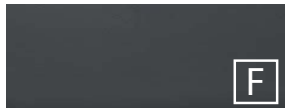

No. 686 anthracite hgl.



No. 722 polar white hgl.



No. 755 hacienda black



No. 769 hacienda grey



no. 670 Halifax oak



no. 680 Charleston oak



No. 750 cardiff oak



no. 784 light oak



Nr. 785 natural oak



no. 786 truffle oak



no. 794 sand oak

**F** foiled front

**M** Melamine coated front with ABS-edge

## carcass colours

\* High gloss carcass for an additional price



No. 164  
Stonegrey matt



No. 177  
cosmos grey  
matt



No. 111  
white matt



no. 191  
quarz grey matt



No. 193  
titanium grey  
matt



\*no. 121  
anthracite hgl.

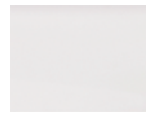

\*no. 161  
white hgl.



no. 155  
hacienda black



no. 169  
hacienda grey



no. 170  
Halifax oak



no. 180  
Charleston oak



no. 150  
cardiff oak



no. 184  
light oak



Nr. 185  
natural oak



no. 186  
truffle oak



no. 194  
sand oak

## Washbasin colours

STONEPLUS washbasins



Series A **STONEPLUS®**

No. 61  
white

evermite - washbasins



Series B **evermite®**

No. 21  
white

Glass washbasin



no. 82  
optiwhite



no. 83  
quartzite gray

## Handle versions



**No. 294 bar handle chrome, narrow variation**

handle bore 96 mm / 384 mm



**No. 296 bar handle chrome, expanded variation**

handle bore 96 mm / 384 mm



**No. 329 Strip handle chrome**

handle length 194 mm / 294 mm / 494 mm



**no. 338 Strip handle aluminium matt**

handle length 194 mm / 294 mm / 494 mm



**No. 339 Strip handle black matt**

handle length 194 mm / 294 mm / 494 mm

## Technique

Pull outs and drawers

No. 554

door with integrated buffered closing

## Mirror cabinets

Series A



Series B



Series C







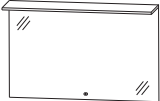

Illustrations and specifications are without obligation. Technical modifications reserved.

2021/2022 - ID

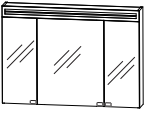

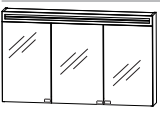



Please note the instruction for warranty, mounting and care, and the quality agreements as well, at the beginning of the book.

# Program 032 - model list

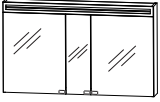
Depth indication corresponds to the carcass depth		Depth in mm	Width in mm	Height in mm	Article number	Hinge	Surchar- ge high- gloss carcass
<b>Mirrors</b>							
	<p><b>Mirror</b></p> <p>1 LED panel light Emotion lighting 1 LED converter incl. LED washbasin lighting This product contains a light source with energy efficiency class: F</p> <p><b>900 mm wide</b> 26,4 watt</p> <p><b>1200 mm wide</b> 35,7 watt</p> <p><b>1400 mm wide</b> 41,9 watt</p> <p><b>1600 mm wide</b> 48,1 watt</p>	91	900	652	<b>F S B 4 1 9 0 0 1</b>		
		91	1200	652	<b>F S B 4 1 1 2 0 1</b>		
		91	1400	652	<b>F S B 4 1 1 4 0 1</b>		
		91	1600	652	<b>F S B 4 1 1 6 0 1</b>		
<b>Mirror cabinets Series A</b>							
	<p><b>Mirror cabinet</b></p> <p>3 double mirror doors 2 central partitions, 6 glass shelves 1 switch socket element 1 mirror panel incl. LED lighting 8,1 Watt / converter 15 Watt Door width: 238 mm / 412 mm / 238 mm This product contains a light source with energy efficiency class: F</p> <p>Additional accessories LED washbasin lighting LED washbasin lighting emotion Emotion lighting</p>	150	900	720	<b>S 2 A 5 8 9 0 6</b>		
					P Z 1 0 6 3 9 0		
incl. handle pads					P Z 1 1 5 0 9 0		
					P Z 1 0 2 0 1		
	<p><b>Mirror cabinet</b></p> <p>3 double mirror doors 2 central partitions, 6 glass shelves 1 switch socket element 1 mirror panel incl. LED lighting 10,6 Watt / converter 30 Watt Door width: 388 mm / 412 mm / 388 mm This product contains a light source with energy efficiency class: F</p> <p>for single washbasin solution</p> <p>Additional accessories LED washbasin lighting LED washbasin lighting emotion Emotion lighting</p>	150	1200	720	<b>S 2 A 5 8 1 2 6</b>		
					P Z 1 0 6 3 1 2		
incl. handle pads					P Z 1 1 5 0 1 2		
					P Z 1 0 2 0 1		

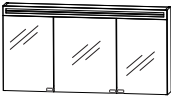

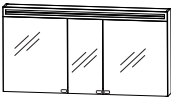



Please observe suitable accessories in the separate index.

# Program 032 - model list

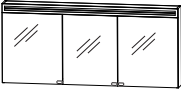
Depth indication corresponds to the carcass depth		Depth in mm	Width in mm	Height in mm	Article number	Hinge	Surcharge high-gloss carcass
<h2>Mirror cabinets Series A</h2>							
  incl. handle pads	<b>Mirror cabinet</b> 3 double mirror doors 2 central partitions, 6 glass shelves 1 switch socket element 1 mirror panel incl. LED lighting 10,6 Watt / converter 30 Watt Door width: 496 mm / 196 mm / 496 mm This product contains a light source with energy efficiency class: F  for double washbasin solutions  Additional accessories LED washbasin lighting LED washbasin lighting emotion Emotion lighting	150	1200	720	<b>S 2 A 5 8 1 2 5</b>		
					P Z 1 0 6 3 12 P Z 1 1 5 0 12 P Z 1 0 2 0 1		
  incl. handle pads	<b>Mirror cabinet</b> 3 double mirror doors 2 central partitions, 6 glass shelves 1 switch socket element 1 mirror panel incl. LED lighting 12,5 Watt / converter 30 Watt Door width: 446 mm / 496 mm / 446 mm This product contains a light source with energy efficiency class: F  for single washbasin solution  Additional accessories LED washbasin lighting LED washbasin lighting emotion Emotion lighting	150	1400	720	<b>S 2 A 5 8 1 4 6</b>		
					P Z 1 0 6 3 12 P Z 1 1 5 0 12 P Z 1 0 2 0 1		
  incl. handle pads	<b>Mirror cabinet</b> 3 double mirror doors 2 central partitions, 6 glass shelves 1 switch socket element 1 mirror panel incl. LED lighting 12,5 Watt / converter 30 Watt Door width: 546 mm / 296 mm / 546 mm This product contains a light source with energy efficiency class: F  for double washbasin solutions  Additional accessories LED washbasin lighting LED washbasin lighting emotion Emotion lighting	150	1400	720	<b>S 2 A 5 8 1 4 5</b>		
					P Z 1 0 6 3 12 P Z 1 1 5 0 12 P Z 1 0 2 0 1		

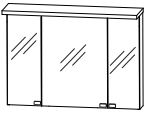

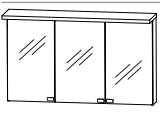



Please observe suitable accessories in the separate index.

# Program 032 - model list

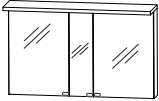
Depth indication corresponds to the carcass depth		Depth in mm	Width in mm	Height in mm	Article number			Hinge	Surcharge high-gloss carcass
<b>Mirror cabinets Series A</b>									
  incl. handle pads	<b>Mirror cabinet</b> 3 double mirror doors 2 central partitions, 6 glass shelves 1 switch socket element 1 mirror panel incl. LED lighting 14,4 Watt / converter 30 Watt Door width: 546 mm / 496 mm / 546 mm This product contains a light source with energy efficiency class: F  Additional accessories LED washbasin lighting LED washbasin lighting emotion Emotion lighting	150	1600	720	<b>S 2 A 5 8 1 6</b>	<b>5</b>			
					P Z	1 0 6 3	12		
					P Z	1 1 5 0	12		
					P Z	1 0 2 0	1		
<b>Mirror cabinets Series B</b>									
  incl. handle pads	<b>Mirror cabinet</b> 3 double mirror doors 2 central partitions, 6 glass shelves 1 switch socket element 1 flyover shelf with LED lighting 2 X 5,1 watt / Converter 15 watt Door width: 238 mm / 412 mm / 238 mm This product contains a light source with energy efficiency class: E  Additional accessories LED washbasin lighting LED washbasin lighting emotion Emotion lighting	150	900	668	<b>S 2 A 4 3 9 0</b>	<b>1 6</b>			
					P Z	1 0 6 3	90		
					P Z	1 1 5 0	90		
					P Z	1 0 2 0	1		
  incl. handle pads	<b>Mirror cabinet</b> 3 double mirror doors 2 central partitions, 6 glass shelves 1 switch socket element 1 flyover shelf with LED lighting 2 X 7,44 watt / converter 30 watt Door width: 388 mm / 412 mm / 388 mm This product contains a light source with energy efficiency class: E  for single washbasin solution  Additional accessories LED washbasin lighting LED washbasin lighting emotion Emotion lighting	150	1200	668	<b>S 2 A 4 3 1 2</b>	<b>1 6</b>			
					P Z	1 0 6 3	12		
					P Z	1 1 5 0	12		
					P Z	1 0 2 0	1		

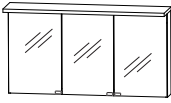

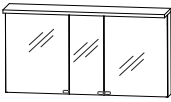



Please observe suitable accessories in the separate index.

# Program 032 - model list

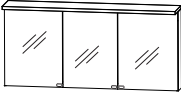
Depth indication corresponds to the carcass depth		Depth in mm	Width in mm	Height in mm	Article number	Hinge	Surcharge high-gloss carcass
<b>Mirror cabinets Series B</b>							
  incl. handle pads	<b>Mirror cabinet</b> 3 double mirror doors 2 central partitions, 6 glass shelves 1 switch socket element 1 flyover shelf with LED lighting 2 X 7,44 watt / converter 30 watt Door width: 496 mm / 196 mm / 496 mm This product contains a light source with energy efficiency class: E  for double washbasin solutions  Additional accessories LED washbasin lighting LED washbasin lighting emotion Emotion lighting	150	1200	668	<b>S 2 A 4 3 1 2 1 5</b>		
  incl. handle pads	<b>Mirror cabinet</b> 3 double mirror doors 2 central partitions, 6 glass shelves 1 switch socket element 1 flyover shelf with LED lighting 2 X 9,0 watt / converter 30 watt Door width: 446 mm / 496 mm / 446 mm This product contains a light source with energy efficiency class: E  for single washbasin solution  Additional accessories LED washbasin lighting LED washbasin lighting emotion Emotion lighting	150	1400	668	<b>S 2 A 4 3 1 4 1 6</b>		
  incl. handle pads	<b>Mirror cabinet</b> 3 double mirror doors 2 central partitions, 6 glass shelves 1 switch socket element 1 flyover shelf with LED lighting 2 X 9,0 watt / converter 30 watt Door width: 546 mm / 296 mm / 546 mm This product contains a light source with energy efficiency class: E  for double washbasin solutions  Additional accessories LED washbasin lighting LED washbasin lighting emotion Emotion lighting	150	1400	668	<b>S 2 A 4 3 1 4 1 5</b>		

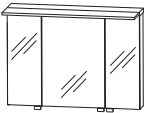
Please observe suitable accessories in the separate index.

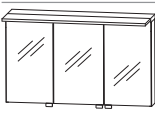





# Program 032 - model list

Depth indication corresponds to the carcass depth		Depth in mm	Width in mm	Height in mm	Article number	Hinge	Surcharge high-gloss carcass
<b>Mirror cabinets Series B</b>							
  incl. handle pads	<b>Mirror cabinet</b> 3 double mirror doors 2 central partitions, 6 glass shelves 1 switch socket element 1 flyover shelf with LED lighting 2 X 10,5 watt / converter 30 watt Door width: 546 mm / 496 mm / 546 mm This product contains a light source with energy efficiency class: E  Additional accessories LED washbasin lighting LED washbasin lighting emotion Emotion lighting	150	1600	668	<b>S 2 A 4 3 1 6 1 5</b>		
					P Z 1 0 6 3 12 P Z 1 1 5 0 12 P Z 1 0 2 0 1		
<b>Mirror cabinets Series C</b>							
  incl. handle blocks	<b>Mirror cabinet</b> 3 double mirror doors 2 central partitions, 6 glass shelves 1 switch socket element 1 LED panel light 13,6 Watt / converter 30 Watt Door width: 238 mm / 412 mm / 238 mm This product contains a light source with energy efficiency class: F  Additional accessories LED washbasin lighting LED washbasin lighting emotion Emotion lighting	150	900	660	<b>S 2 A 4 3 9 0 7 8</b>		
					P Z 1 0 6 3 90 P Z 1 1 5 0 90 P Z 1 0 2 0 1		
  incl. handle blocks	<b>mirror cabinet</b> 3 double mirror doors 2 central partitions, 6 glass shelves 1 switch socket element 1 LED panel light 18,2 watt / converter 30watt Door width: 388 mm / 412 mm / 388 mm This product contains a light source with energy efficiency class: F  for single washbasin solution  Additional accessories LED washbasin lighting LED washbasin lighting emotion Emotion lighting	150	1200	660	<b>S 2 A 4 3 1 2 7 8</b>		
					P Z 1 0 6 3 12 P Z 1 1 5 0 12 P Z 1 0 2 0 1		

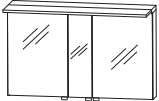
Please observe suitable accessories in the separate index.

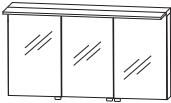

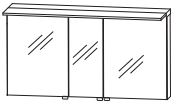
# Program 032 - model list

Depth indication corresponds to the carcass depth		Depth in mm	Width in mm	Height in mm	Article number	Hinge	Surcharge high-gloss carcass
<b>Mirror cabinets Series C</b>							
  incl. handle blocks	<b>mirror cabinet</b> 3 double mirror doors 2 central partitions, 6 glass shelves 1 switch socket element 1 LED panel light 18,2 watt / converter 30watt Door width: 496 mm / 196 mm / 496 mm This product contains a light source with energy efficiency class: F  for double washbasin solutions  Additional accessories LED washbasin lighting LED washbasin lighting emotion Emotion lighting	150	1200	660	<b>S 2 A 4 3 1 2 7 7</b>		
  incl. handle blocks	<b>mirror cabinet</b> 3 double mirror doors 2 central partitions, 6 glass shelves 1 switch socket element 1 LED panel light 21,3 watt / converter 30 watt Door width: 446 mm / 496 mm / 446 mm This product contains a light source with energy efficiency class: F  for single washbasin solution  Additional accessories LED washbasin lighting LED washbasin lighting emotion Emotion lighting	150	1400	660	<b>S 2 A 4 3 1 4 7 8</b>		
  incl. handle blocks	<b>mirror cabinet</b> 3 double mirror doors 2 central partitions, 6 glass shelves 1 switch socket element 1 LED panel light 21,3 watt / converter 30 watt Door width: 546 mm / 296 mm / 546 mm This product contains a light source with energy efficiency class: F  for double washbasin solutions  Additional accessories LED washbasin lighting LED washbasin lighting emotion Emotion lighting	150	1400	660	<b>S 2 A 4 3 1 4 7 7</b>		

Please observe suitable accessories in the separate index.

# Program 032 - model list

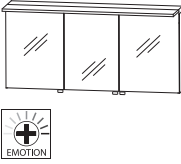
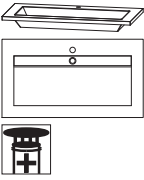
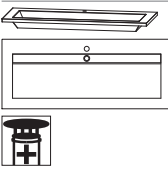
Depth indication corresponds to the carcass depth		Depth in mm	Width in mm	Height in mm	Article number	Hinge	Surcharge high-gloss carcass
<h2>Mirror cabinets Series C</h2>							
 <p><b>mirror cabinet</b>            3 double mirror doors            2 central partitions,            6 glass shelves            1 switch socket element            1 LED panel light            24,4 watt / converter 30 watt            Door width: 546 mm / 496 mm / 546 mm            This product contains a light source with energy efficiency class: F</p> <p>incl. handle blocks</p> <p>Additional accessories            LED washbasin lighting            LED washbasin lighting emotion            Emotion lighting</p>	150	1600	660	<b>S 2 A 4 3 1 6 7 7</b>			
<h2>STONEPLUS washbasins Series A</h2>							
 <p><b>STONEPLUS washbasin, 900 mm</b>            colour white            1 tap hole            1 drain cover            incl. permanent drain</p> <p>can be combined with WUA 3390 07</p> <p>Additional accessories            CLOU drain and overflow system            LED lighting frame            motion sensor for LED lighting            Surcharge for washbasins without tap-hole or with 3 holes (according to sketch)</p>	495	906	18	<b>W M E 9 1 9 E 6 1</b>			
 <p><b>STONEPLUS washbasin, 1.200 mm</b>            colour white            1 tap hole            1 drain cover            incl. permanent drain</p> <p>can be combined with WUA 3312 07</p> <p>Additional accessories            CLOU drain and overflow system            LED lighting frame            motion sensor for LED lighting            Surcharge for washbasins without tap-hole or with 3 holes (according to sketch)</p>	495	1206	18	<b>W M E 9 1 2 E 6 1</b>			
					P Z	1 0 6 3	12
					P Z	1 1 5 0	12
					P Z	1 0 2 0	1
					P Z	1 1 0 9	1
					P Z	1 0 6 1	90
					P Z	1 1 4 1	
					P Z	1 1 0 9	1
					P Z	1 0 6 1	12
					P Z	1 1 4 1	

\*Delivery time: 8 weeks. Price per washbasin. Washbasin without tap hole is incompatible with CLOU System. Please check your order confirmation for correctness.

# Program 032 - model list

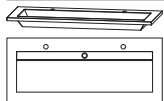
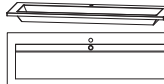
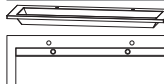
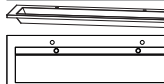
Depth indication corresponds to the carcass depth		Depth in mm	Width in mm	Height in mm	Article number	Hinge	Surcharge high-gloss carcass
<b>STONEPLUS washbasins Series A</b>							
	<b>STONEPLUS double washbasin, 1200 mm,</b> colour white 2 tap holes 1 drain cover incl. permanent drain  can be combined with WUA 3312 7, WUA 3312 07  Additional accessories LED lighting frame motion sensor for LED lighting Surcharge for washbasins without tap-hole or with 3 holes (according to sketch)	495	1206	18	<b>WME 9 1 2 D 6 1</b>   PZ 1 0 6 1 12 PZ 1 1 4 1		
	<b>STONEPLUS washbasin, 1400 mm</b> colour white 1 tap hole 1 drain cover incl. permanent drain  can be combined with WUA 3314 07  Additional accessories CLOU drain and overflow system LED lighting frame motion sensor for LED lighting Surcharge for washbasins without tap-hole or with 3 holes (according to sketch)	495	1406	18	<b>WME 9 1 4 E 6 1</b>   PZ 1 1 0 9 1 PZ 1 0 6 1 14 PZ 1 1 4 1		
	<b>STONEPLUS double washbasin, 1400 mm</b> colour white 2 tap holes 1 drain cover incl. permanent drain  can be combined with WUA 3314 7, WUA 3314 07  Additional accessories CLOU drain and overflow system (order 2 pieces) LED lighting frame motion sensor for LED lighting Additional price for Washbasin without tap hole / with 3 holes (acc. to sketch).	495	1406	18	<b>WME 9 1 4 D 6 1</b>   PZ 1 1 0 9 1 PZ 1 0 6 1 14 PZ 1 1 4 1		
	<b>STONEPLUS double washbasin, 1600 mm</b> colour white 2 tap holes 1 drain cover incl. permanent drain  can be combined with WUA 3316 7  Additional accessories CLOU drain and overflow system (order 2 pieces) LED lighting frame motion sensor for LED lighting Additional price for Washbasin without tap hole / with 3 holes (acc. to sketch).	495	1606	18	<b>WME 9 1 6 D 6 1</b>   PZ 1 1 0 9 1 PZ 1 0 6 1 16 PZ 1 1 4 1		



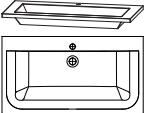
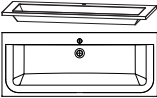
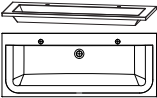
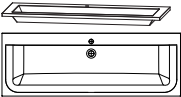
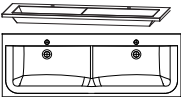

\*Delivery time: 8 weeks. Price per washbasin. Washbasin without tap hole is incompatible with CLOU System. Please check your order confirmation for correctness.

# Program 032 - model list

Depth indication corresponds to the carcass depth		Depth in mm	Width in mm	Height in mm	Article number	Hinge	Surchar- ge high- gloss carcass
<b>evermite - washbasins</b> <b>Series B</b>							
	<b>evermite washbasin, 900 mm</b> colour white 1 tap hole inkl. concealed overflow system chrome finish  can be combined with WUA 3390 07  Additional accessories LED lighting frame motion sensor for LED lighting Surcharge for washbasins without tap-hole or with 3 holes (according to sketch)	495	906	18	<b>SWM 9 2 9 E 2 1</b>  P Z 1 0 6 1 90 P Z 1 1 4 1		
	<b>evermite washbasin, 1200 mm</b> colour white 1 tap hole inkl. concealed overflow system chrome finish  can be combined with WUA 3312 07  Additional accessories LED lighting frame motion sensor for LED lighting Surcharge for washbasins without tap-hole or with 3 holes (according to sketch)	495	1206	18	<b>SWM 9 2 2 E 2 1</b>  P Z 1 0 6 1 12 P Z 1 1 4 1		
	<b>evermite double washbasin, 1200 mm</b> colour white 2 tap holes incl. permanent drain  can be combined with WUA 3312 7, WUA 3312 07  Additional accessories LED lighting frame motion sensor for LED lighting Surcharge for washbasins without tap-hole or with 3 holes (according to sketch)	495	1206	18	<b>SWM 9 2 2 D 2 1</b>  P Z 1 0 6 1 12 P Z 1 1 4 1		
	<b>evermite washbasin, 1400 mm</b> colour white 1 tap hole inkl. concealed overflow system chrome finish  can be combined with WUA 3314 07  Additional accessories LED lighting frame motion sensor for LED lighting Surcharge for washbasins without tap-hole or with 3 holes (according to sketch)	495	1406	18	<b>SWM 9 2 4 E 2 1</b>  P Z 1 0 6 1 14 P Z 1 1 4 1		
	<b>evermite double washbasin, 1400 mm</b> colour white 2 tap holes inkl. concealed overflow system chrome finish  can be combined with WUA 3314 7, WUA 3314 07  Additional accessories LED lighting frame motion sensor for LED lighting Surcharge for washbasins without tap-hole or with 3 holes (according to sketch)	495	1406	18	<b>SWM 9 2 4 D 2 1</b>  P Z 1 0 6 1 14 P Z 1 1 4 1		

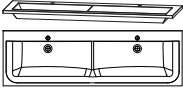

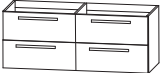



\*Delivery time: 8 weeks. Price per washbasin. Washbasin without tap hole is incompatible with CLOU System. Please check your order confirmation for correctness.

# Program 032 - model list

Depth indication corresponds to the carcass depth		Depth in mm	Width in mm	Height in mm	Article number	Hinge	Surcharge high-gloss carcass
<h2>evermite - washbasins</h2> <h3>Series B</h3>							
 <p><b>evermite double washbasin, 1600 mm</b>            colour white            2 tap holes            inkl. concealed overflow system chrome finish</p> <p>can be combined with WUA 3316 7</p> <p>Additional accessories            LED lighting frame            motion sensor for LED lighting            Surcharge for washbasins without tap-hole or with 3 holes (according to sketch)</p>	495	1606	18	<b>SWM 9 2 6 D 2 1</b>			
					P Z 1 0 6 1 P Z 1 1 4 1	16	
<h2>Washbasin base units</h2>							
 <p><b>Washbasin base unit</b>            1 metal pull out unit with buffered closing and rail            1 metal pull-out with buffered closing</p> <p>for evermite and STONEPLUS washbasins</p> <p>Additional accessories            Space-saving drain stench trap DN 40            Space-saving drain stench trap DN 32</p>	470	900	480	<b>WUA 3 3 9 0 0 7</b>			
					P Z 1 3 6 7 P Z 1 4 2 3		
 <p><b>Washbasin base unit</b>            consisting of 2 elements            2 metal pull-out units with buffered closing incl. drawer rail            2 metal pull-outs with buffered closing,</p> <p>for evermite and STONEPLUS washbasins</p> <p>Additional accessories            Space-saving drain stench trap DN 40            Space-saving drain stench trap DN 32</p>	470	1200	480	<b>WUA 3 3 1 2 7</b>			
					P Z 1 3 6 7 P Z 1 4 2 3		
 <p><b>Washbasin base unit</b>            1 metal pull out unit with buffered closing and rail            1 metal pull-out with buffered closing</p> <p>for evermite and STONEPLUS washbasins</p> <p>Additional accessories            Space-saving drain stench trap DN 40            Space-saving drain stench trap DN 32</p>	470	1200	480	<b>WUA 3 3 1 2 0 7</b>			
					P Z 1 3 6 7 P Z 1 4 2 3		
 <p><b>Washbasin base unit</b>            consisting of 2 elements            2 metal pull-out units with buffered closing incl. drawer rail            2 metal pull-outs with buffered closing,</p> <p>for evermite and STONEPLUS washbasins</p> <p>Additional accessories            Space-saving drain stench trap DN 40 (order 2 pieces)            Space-saving drain stench trap DN 32 (order 2 pieces)</p>	470	1400	480	<b>WUA 3 3 1 4 7</b>			
					P Z 1 3 6 7 P Z 1 4 2 3		

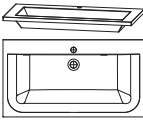

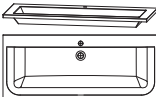



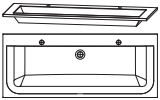

\*Delivery time: 8 weeks. Price per washbasin. Washbasin without tap hole is incompatible with CLOU System. Please check your order confirmation for correctness.

# Program 032 - model list

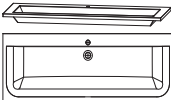
Depth indication corresponds to the carcass depth		Depth in mm	Width in mm	Height in mm	Article number	Hinge	Surcharge high-gloss carcass
<b>Washbasin base units</b>							
	<p><b>Washbasin base unit</b> 1 metal pull out unit with buffered closing and rail 1 metal pull-out with buffered closing</p> <p>for evermite and STONEPLUS washbasins</p> <p>Additional accessories Space-saving drain stench trap DN 40 Space-saving drain stench trap DN 32</p>	470	1400	480	<b>WUA 3 3 1 4 0 7</b>		
					P Z 1 3 6 7 P Z 1 4 2 3		
	<p><b>Washbasin base unit</b> consisting of 2 elements 2 metal pull-out units with buffered closing incl. drawer rail 2 metal pull-outs with buffered closing,</p> <p>for evermite and STONEPLUS washbasins</p> <p>Additional accessories Space-saving drain stench trap DN 40 (order 2 pieces) Space-saving drain stench trap DN 32 (order 2 pieces)</p>	470	1600	480	<b>WUA 3 3 1 6 7</b>		
					P Z 1 3 6 7 P Z 1 4 2 3		
<b>Glass washbasin</b>							
	<p><b>Glass washbasin, 900 mm</b> Colour Optiwhite</p> <p>Colour quartzite gray</p> <p>1 tap hole inkl. concealed overflow system chrome finish</p> <p>can be combined with WUA 3390 09</p> <p>Additional accessories Neutrally bonding silicone for glass washbasins Surcharge for washbasins without tap-hole or with 3 holes (according to sketch)</p>	495	906	12	<b>WGS 9 2 9 E 8 2</b>		
		495	906	12	<b>WGS 9 2 9 E 8 3</b>		
					P Z 1 2 3 5		
	<p><b>Glass washbasin, 1200 mm</b> Colour Optiwhite</p> <p>Colour quartzite gray</p> <p>1 tap hole inkl. concealed overflow system chrome finish</p> <p>can be combined with WUA 3312 09</p> <p>Additional accessories Neutrally bonding silicone for glass washbasins Surcharge for washbasins without tap-hole or with 3 holes (according to sketch)</p>	495	1206	12	<b>WGS 9 2 2 E 8 2</b>		
		495	1206	12	<b>WGS 9 2 2 E 8 3</b>		
					P Z 1 2 3 5		

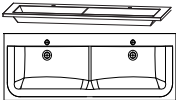

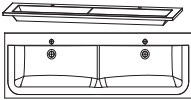

\*Delivery time: 8 weeks. Price per washbasin. Washbasin without tap hole is incompatible with CLOU System. Please check your order confirmation for correctness.

# Program 032 - model list

Depth indication corresponds to the carcass depth		Depth in mm	Width in mm	Height in mm	Article number			Hinge	Surcharge high-gloss carcass
<b>Glass washbasin</b>									
	<b>Glass double washbasin, 1200 mm</b>								
	Colour Optiwhite	495	1206	12	<b>WGS 9 2 2 D 8 2</b>				
	Colour quartzite gray	495	1206	12	<b>WGS 9 2 2 D 8 3</b>				
	2 tap holes incl. not lockable flow-off valve								
	can be combined with WUA 3312 09								
	Additional accessories Neutrally bonding silicone for glass washbasins Surcharge for washbasins without tap-hole or with 3 holes (according to sketch)				P Z	1 2 3 5			
	<b>Glass washbasin, 1400 mm</b>								
	Colour Optiwhite	495	1406	12	<b>WGS 9 2 4 E 8 2</b>				
	Colour quartzite gray	495	1406	12	<b>WGS 9 2 4 E 8 3</b>				
	1 tap hole inkl. concealed overflow system chrome finish								
	can be combined with WUA 3314 09								
	Additional accessories Neutrally bonding silicone for glass washbasins Surcharge for washbasins without tap-hole or with 3 holes (according to sketch)				P Z	1 2 3 5			
	<b>Glass double washbasin, 1400 mm</b>								
	Colour Optiwhite	495	1406	12	<b>WGS 9 2 4 D 8 2</b>				
	Colour quartzite gray	495	1406	12	<b>WGS 9 2 4 D 8 3</b>				
	2 tap holes inkl. 2 concealed overflow systems chrome finish								
	can be combined with WUA 3314 9								
	Additional accessories Neutrally bonding silicone for glass washbasins Surcharge for washbasins without tap-hole or with 3 holes (according to sketch)				P Z	1 2 3 5			
	<b>Glass double washbasin, 1600 mm</b>								
	Colour Optiwhite	495	1606	12	<b>WGS 9 2 6 D 8 2</b>				
	Colour quartzite gray	495	1606	12	<b>WGS 9 2 6 D 8 3</b>				
	2 tap holes inkl. 2 concealed overflow systems chrome finish								
	can be combined with WUA 3316 9								
	Additional accessories Neutrally bonding silicone for glass washbasins Surcharge for washbasins without tap-hole or with 3 holes (according to sketch)				P Z	1 2 3 5			

\*Delivery time: 8 weeks. Price per washbasin. Washbasin without tap hole is incompatible with CLOU System. Please check your order confirmation for correctness.

# Program 032 - model list

Depth indication corresponds to the carcass depth		Depth in mm	Width in mm	Height in mm	Article number	Hinge	Surchar- ge high- gloss carcass
<b>Washbasin base units</b>							
	<p><b>Washbasin base unit</b> 1 metal pull out unit with buffered closing and rail 1 metal pull out unit with buffered closing</p> <p>for glass washbasins</p> <p>Additional accessories Space-saving drain stench trap DN 40 Space-saving drain stench trap DN 32</p>	470	900	480	<b>W U A 3 3 9 0 0 9</b>  P Z 1 3 6 7 P Z 1 4 2 3		
	<p><b>Washbasin base unit</b> 1 metal pull out unit with buffered closing and rail 1 metal pull out unit with buffered closing</p> <p>for glass washbasins</p> <p>Additional accessories Space-saving drain stench trap DN 40 Space-saving drain stench trap DN 32</p>	470	1200	480	<b>W U A 3 3 1 2 0 9</b>  P Z 1 3 6 7 P Z 1 4 2 3		
	<p><b>Washbasin base unit</b> 1 metal pull out unit with buffered closing and rail 1 metal pull out unit with buffered closing</p> <p>for glass washbasins</p> <p>Additional accessories Space-saving drain stench trap DN 40 Space-saving drain stench trap DN 32</p>	470	1400	480	<b>W U A 3 3 1 4 0 9</b>  P Z 1 3 6 7 P Z 1 4 2 3		
	<p><b>Washbasin base unit</b> consisting of 2 elements 2 metal pull-out units with buffered closing incl. drawer rail 2 metal pull out units with buffered closing and syphon cut- out</p> <p>for glass washbasins</p> <p>Additional accessories Space-saving drain stench trap DN 40 (order 2 pieces) Space-saving drain stench trap DN 32 (order 2 pieces)</p>	470	1400	480	<b>W U A 3 3 1 4 9</b>  P Z 1 3 6 7 P Z 1 4 2 3		
	<p><b>Washbasin base unit</b> consisting of 2 elements 2 metal pull-out units with buffered closing incl. drawer rail 2 metal pull out units with buffered closing and syphon cut- out</p> <p>for glass washbasins</p> <p>Additional accessories Space-saving drain stench trap DN 40 (order 2 pieces) Space-saving drain stench trap DN 32 (order 2 pieces)</p>	470	1600	480	<b>W U A 3 3 1 6 9</b>  P Z 1 3 6 7 P Z 1 4 2 3		

Please observe suitable accessories in the separate index.

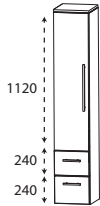
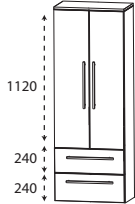
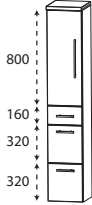
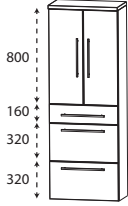
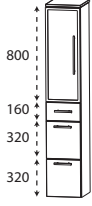

# Program 032 - model list

Depth indication corresponds to the carcass depth		Depth in mm	Width in mm	Height in mm	Article number	Hinge	Surcharge high-gloss carcass
	<b>Tall unit</b> 1 door 4 glass shelves 2 metal pull-outs with buffered closing 1 top cover 330 mm deep	300	300	1628	<b>HNA083A71</b>	L/R	
		300	400	1628	<b>HNA084A71</b>	L/R	
	<b>Tall unit</b> 2 doors 4 glass shelves 2 metal pull-outs with buffered closing 1 top cover 330 mm deep	300	600	1628	<b>HNA086A71</b>		
	<b>Tall unit</b> 1 door 2 glass shelves (top) 2 metal pull-outs with buffered closing 1 drawer with buffered closing 1 top cover 330 mm deep	300	300	1628	<b>HNA093A7M</b>	L/R	
		300	400	1628	<b>HNA094A7M</b>	L/R	
	<b>Tall unit</b> 2 doors 2 glass shelves (top) 2 metal pull-outs with buffered closing 1 drawer with buffered closing 1 top cover 330 mm deep	300	600	1628	<b>HNA096A7M</b>		
	<b>Tall unit</b> 1 aluminium framed door with satined glass 2 glass shelves (top) 2 metal pull-outs with buffered closing 1 drawer with buffered closing 1 top cover 330 mm deep	300	300	1628	<b>HNA093B7M</b>	L/R	
		300	600	1628	<b>HNA096B7M</b>		

Please observe suitable accessories in the separate index.

# Program 032 - model list

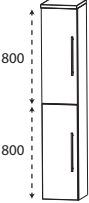
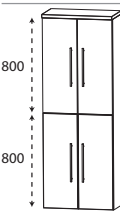
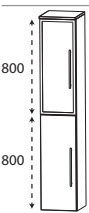
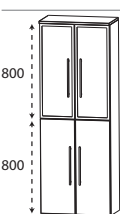
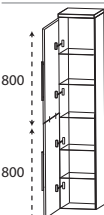
Depth indication corresponds to the carcass depth		Depth in mm	Width in mm	Height in mm	Article number	Hinge	Surcharge high-gloss carcass
<b>Tall units</b>							
	<b>Tall unit</b> 2 doors 2 glass shelves (top) 2 adjustable shelves (bottom) 1 top cover 330 mm deep	300	300	1628	<b>H N A 0 3 3 A</b>	7 L/R	
		300	400	1628	<b>H N A 0 3 4 A</b>	7 L/R	
	Variable in width: please quote the exact dimension of carcass depth. Top cover will be adapted to the cupboard width.	150-299	300	1628	<b>H V A 0 3 3 0</b>	L/R	
		150-299	400	1628	<b>H V A 0 3 4 0</b>	L/R	
	<b>Tall unit</b> 4 doors 2 glass shelves (top) 2 adjustable shelves (bottom) 1 top cover 330 mm deep	300	600	1628	<b>H N A 0 3 6 A</b>	7	
	Variable in width: please quote the exact dimension of carcass depth. Top cover will be adapted to the cupboard width.	150-299	600	1628	<b>H V A 0 3 6 0</b>		
	<b>Tall unit</b> 1 aluminium framed door with satined glass 1 door 2 glass shelves (top) 2 adjustable shelves (bottom) 1 top cover 330 mm deep	300	300	1628	<b>H N A 0 3 3 B</b>	7 L/R	
	Variable in width: please quote the exact dimension of carcass depth. Top cover will be adapted to the cupboard width.	150-299	300	1628	<b>H V A 0 3 3 1</b>	L/R	
	<b>Tall unit</b> 2 aluminium framed doors with satined glass 2 doors 2 glass shelves (top) 2 adjustable shelves (bottom) 1 top cover 330 mm deep	300	600	1628	<b>H N A 0 3 6 B</b>	7	
	Variable in width: please quote the exact dimension of carcass depth. Top cover will be adapted to the cupboard width.	150-299	600	1628	<b>H V A 0 3 6 1</b>		
	<b>Tall unit for brooms</b> 2 strapped doors 5 glass shelves 1 top cover 330 mm deep	300	300	1628	<b>H N A 0 3 3 A 7 1</b>	L/R	
		300	400	1628	<b>H N A 0 3 4 A 7 1</b>	L/R	

Please observe suitable accessories in the separate index.

# Program 032 - model list

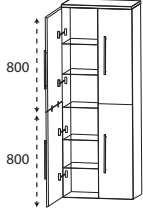
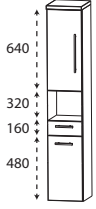
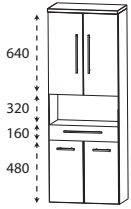
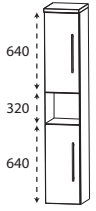
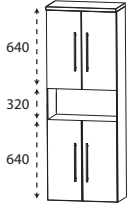
	Depth in mm	Width in mm	Height in mm	Article number	Hinge	Surcharge high-gloss carcass
<p>Depth indication corresponds to the carcass depth</p> <p><b>Tall units</b></p>  <p><b>Tall unit for brooms</b>            2 strapped doors left            2 strapped doors right            5 continuously glass shelves            1 top cover 330 mm deep</p>	300	600	1628	<b>HNA036A71</b>		
 <p><b>Tall unit</b>            1 door            1 glass shelf (top)            1 open compartment            1 drawer with buffered closing            1 door            1 glass shelf            1 top cover 330 mm deep</p>	300 300	300 400	1628 1628	<b>HNA023A71</b> <b>HNA024A71</b>	L/R L/R	
 <p><b>Tall unit</b>            2 doors            1 glass shelf (top)            1 open compartment            1 drawer with buffered closing            2 doors            1 glass shelf            1 top cover 330 mm deep</p>	300	600	1628	<b>HNA026A71</b>		
 <p><b>Tall unit</b>            1 door            1 glass shelf (top)            1 open compartment            1 door            1 glass shelf            1 top cover 330 mm deep</p>	300 300	300 400	1628 1628	<b>HNA023A72</b> <b>HNA024A72</b>	L/R L/R	
 <p><b>Tall unit</b>            2 doors            1 glass shelf (top)            1 open compartment            2 doors            1 glass shelf            1 top cover 330 mm deep</p>	300	600	1628	<b>HNA026A72</b>		

Please observe suitable accessories in the separate index.

# Program 032 - model list

Depth indication corresponds to the carcass depth

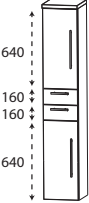
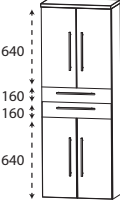
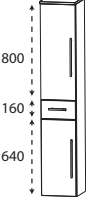
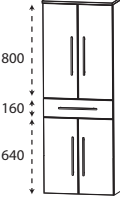
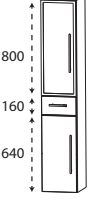
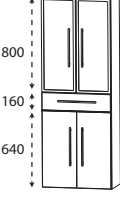
	Depth in mm	Width in mm	Height in mm	Article number	Hinge	Surcharge high-gloss carcass
	300	300	1628	<b>HNA043A71</b>	L/R	
	300	400	1628	<b>HNA044A71</b>	L/R	
	300	600	1628	<b>HNA046A71</b>		
	300	300	1628	<b>HNA053A7M</b>	L/R	
	300	400	1628	<b>HNA054A7M</b>	L/R	
	300	600	1628	<b>HNA056A7M</b>		
	300	300	1628	<b>HNA053B7M</b>	L/R	
	300	600	1628	<b>HNA056B7M</b>		

Please observe suitable accessories in the separate index.

# Program 032 - model list

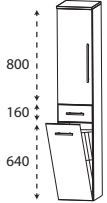
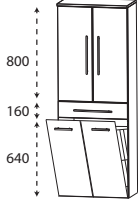
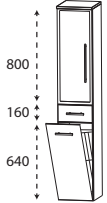
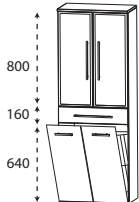
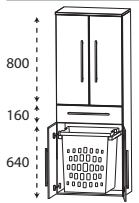
Depth indication corresponds to the carcass depth		Depth in mm	Width in mm	Height in mm	Article number	Hinge	Surcharge high-gloss carcass
<b>Tall units</b>							
	<b>Tall unit with laundry basket</b> 1 door 2 glass shelves 1 drawer with buffered closing 1 laundry basket with wire basket 1 top cover 330 mm deep  Volume of laundry basket: 25 liters	300	300	1628	<b>HNA053A7W</b>	L/R	
	Volume of laundry basket: 35 liters	300	400	1628	<b>HNA054A7W</b>	L/R	
	<b>Tall unit with laundry basket</b> 2 doors 2 glass shelves 1 drawer with buffered closing 1 laundry basket with wire basket 1 top cover 330 mm deep  Volume of laundry basket: 55 liters	300	600	1628	<b>HNA056A7W</b>		
	<b>Tall unit with laundry basket</b> 1 aluminium framed door with satined glass 2 glass shelves 1 drawer with buffered closing 1 laundry basket with wire basket 1 top cover 330 mm deep  Volume of laundry basket: 25 liters	300	300	1628	<b>HNA053B7W</b>	L/R	
	<b>Tall unit with laundry basket</b> 2 aluminium framed doors with satined glass 2 glass shelves 1 drawer with buffered closing 1 laundry basket with wire basket 1 top cover 330 mm deep  Volume of laundry basket: 55 liters	300	600	1628	<b>HNA056B7W</b>		
	<b>Tall unit with laundry pull out</b> 2 doors 2 glass shelves (top) 1 drawer with buffered closing 2 doors 1 laundry pull out with wire basket 1 top cover 330 mm deep  Volume of laundry pull out: 40 liters	300	600	1628	<b>HNA056A1W</b>		

Please observe suitable accessories in the separate index.

# Program 032 - model list

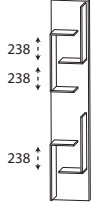
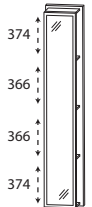
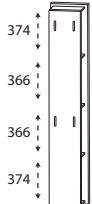
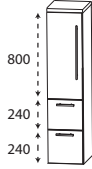
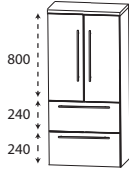
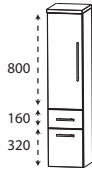
Depth indication corresponds to the carcass depth		Depth in mm	Width in mm	Height in mm	Article number		Hinge	Surcharge high-gloss carcass
<b>Tall unit-shelf</b>								
	<b>Tall unit-shelf</b> with open shelf space in carcass colour	150	300	1600	<b>R G</b>	<b>1 0 3 0 0 1</b>		
	<b>Tall unit-shelf</b> with mirror surface 4 shelves compartments in carcass colour	150	300	1600	<b>R G</b>	<b>1 0 3 0 0 2</b>		
	<b>Tall unit-shelf</b> 4 functional hooks 4 shelves compartments in carcass colour	150	300	1600	<b>R G</b>	<b>1 0 3 0 0 3</b>		
<b>Central units</b>								
	<b>medium-high unit</b> 1 door 2 glass shelves (top) 2 metal pull-outs with buffered closing 1 top cover 330 mm deep	300	300	1308	<b>M N A</b>	<b>8 7 3 A</b>	<b>7</b>	L/R
		300	400	1308	<b>M N A</b>	<b>8 7 4 A</b>	<b>7</b>	L/R
	<b>medium-high unit</b> 2 doors 2 glass shelves (top) 2 metal pull-outs with buffered closing 1 top cover 330 mm deep	300	600	1308	<b>M N A</b>	<b>8 7 6 A</b>	<b>7</b>	
	<b>medium-high unit</b> 1 door 2 glass shelves (top) 1 metal pull-out with buffered closing, 1 drawer with buffered closing 1 top cover 330 mm deep	300	300	1308	<b>M N A</b>	<b>8 8 3 A</b>	<b>7 M</b>	L/R
		300	400	1308	<b>M N A</b>	<b>8 8 4 A</b>	<b>7 M</b>	L/R

Please observe suitable accessories in the separate index.

# Program 032 - model list

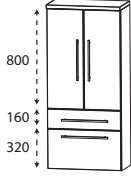
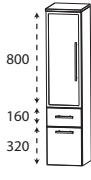
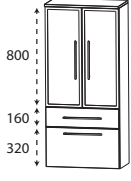
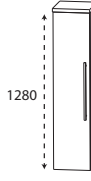
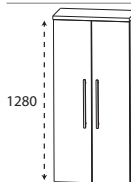
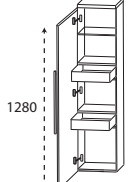
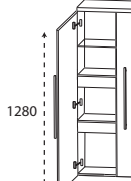
Depth indication corresponds to the carcass depth		Depth in mm	Width in mm	Height in mm	Article number	Hinge	Surcharge high-gloss carcass
<b>Central units</b>							
	<b>medium-high unit</b> 2 doors 2 glass shelves (top) 1 metal pull-out with buffered closing, 1 drawer with buffered closing 1 top cover 330 mm deep	300	600	1308	<b>M N A 8 8 6 A 7 M</b>		
	<b>medium-high unit</b> 1 aluminium framed door with satined glass 2 glass shelves (top) 1 metal pull-out with buffered closing, 1 drawer with buffered closing 1 top cover 330 mm deep	300	300	1308	<b>M N A 8 8 3 B 7 M</b>	L/R	
	<b>medium-high unit</b> 2 aluminium framed doors with satined glass 2 glass shelves (top) 1 metal pull-out with buffered closing, 1 drawer with buffered closing 1 top cover 330 mm deep	300	600	1308	<b>M N A 8 8 6 B 7 M</b>		
	<b>medium-high unit</b> 1 door 4 glass shelves 1 top cover 330 mm deep  Variable in width: please quote the exact dimension of carcass depth. Top cover will be adapted to the cupboard width.	300	300	1308	<b>M N A 8 1 3 A</b>	7	L/R
		300	400	1308	<b>M N A 8 1 4 A</b>	7	L/R
		150-299	300	1308	<b>M V A 8 1 3 0</b>		L/R
		150-299	400	1308	<b>M V A 8 1 4 0</b>		L/R
	<b>medium-high unit</b> 2 doors 4 glass shelves 1 top cover 330 mm deep  Variable in width: please quote the exact dimension of carcass depth. Top cover will be adapted to the cupboard width.	300	600	1308	<b>M N A 8 1 6 A</b>	7	
		150-299	600	1308	<b>M V A 8 1 6 0</b>		
	<b>medium-high unit with inside drawers</b> 1 door 2 inside metal-drawer with buffered closing 1 glass shelf 1 top cover 330 mm deep	300	300	1308	<b>M N A 8 4 3 A</b>	7	L/R
		300	400	1308	<b>M N A 8 4 4 A</b>	7	L/R
	<b>medium-high unit with inside drawers</b> 2 doors 2 continuously inside metal-drawer with buffered closing 1 continuous glass shelf 1 top cover 330 mm deep	300	600	1308	<b>M N A 8 4 6 A</b>	7	

Please observe suitable accessories in the separate index.

# Program 032 - model list

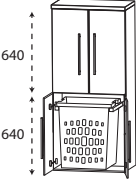
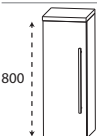
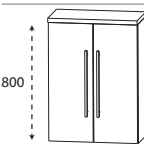
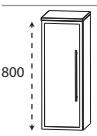
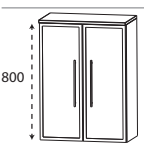
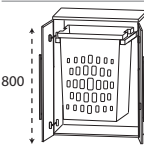
Depth indication corresponds to the carcass depth		Depth in mm	Width in mm	Height in mm	Article number		Hinge	Surcharge high-gloss carcass
<b>Central units</b>								
	<p><b>medium-high unit with laundry pull out</b>            2 doors            1 glass shelf (top)            2 doors            1 laundry pull out with wire basket            Volume of laundry pull out: 40 liters            1 top cover 330 mm deep</p>	300	600	1308	<b>MNA836A1W</b>			
<b>Highboards</b>								
	<p><b>Highboard</b>            1 door            2 glass shelves            1 top cover 330 mm deep</p> <p>Variable in width:            please quote the exact dimension of carcass depth.            Top cover will be adapted to the cupboard width.</p>	300 300 150-299 150-299	300 400 300 400	828 828 828 828	<b>HBA513A</b> <b>HBA514A</b> <b>HBVA513</b> <b>HBVA514</b>	<b>7</b> <b>7</b> <b>L/R</b> <b>L/R</b>		
	<p><b>Highboard</b>            2 doors            2 glass shelves            1 top cover 330 mm deep</p> <p>Variable in width:            please quote the exact dimension of carcass depth.            Top cover will be adapted to the cupboard width.</p>	300 150-299	600 600	828 828	<b>HBA516A</b> <b>HBVA516</b>	<b>7</b> <b>L/R</b>		
	<p><b>Highboard</b>            1 aluminium framed door with satined glass            2 glass shelves            1 top cover 330 mm deep</p> <p>Variable in width:            please quote the exact dimension of carcass depth.            Top cover will be adapted to the cupboard width.</p>	300 150-299	300 300	828 828	<b>HBA513B</b> <b>HBVA513</b>	<b>7</b> <b>1</b> L/R		
	<p><b>Highboard</b>            2 aluminium framed doors with satined glass            2 glass shelves            1 top cover 330 mm deep</p> <p>Variable in width:            please quote the exact dimension of carcass depth.            Top cover will be adapted to the cupboard width.</p>	300 150-299	600 600	828 828	<b>HBA516B</b> <b>HBVA516</b>	<b>7</b> <b>1</b>		
	<p><b>Highboard with laundry pull out</b>            2 doors            1 laundry pull out with wire basket            1 top cover 330 mm deep</p> <p>Volume of laundry pull out: 40 liters</p>	300	600	828	<b>HBA516A1W</b>			

Please observe suitable accessories in the separate index.





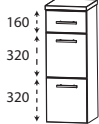
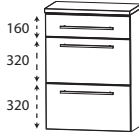
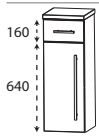
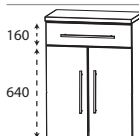
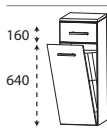
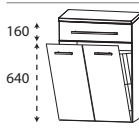
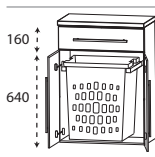

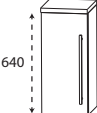
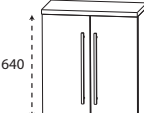
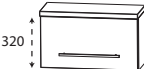

# Program 032 - model list

Depth indication corresponds to the carcass depth		Depth in mm	Width in mm	Height in mm	Article number	Hinge	Surcharge high-gloss carcass
<b>Highboards</b>							
 <p>160 320 320</p>	<b>Highboard</b> 1 drawer with buffered closing 2 metal pull-outs with buffered closing 1 top cover 330 mm deep	300	300	828	<b>H B A 5 6 3 A 7 M</b>		
		300	400	828	<b>H B A 5 6 4 A 7 M</b>		
 <p>160 320 320</p>	<b>Highboard</b> 1 drawer with buffered closing 2 metal pull-outs with buffered closing 1 top cover 330 mm deep	300	600	828	<b>H B A 5 6 6 A 7 M</b>		
 <p>160 640</p>	<b>Highboard</b> 1 drawer with buffered closing 1 door 1 glass shelf 1 top cover 330 mm deep	300	300	828	<b>H B A 5 5 3 A 7 M</b>	L/R	
		300	400	828	<b>H B A 5 5 4 A 7 M</b>	L/R	
 <p>160 640</p>	<b>Highboard</b> 1 drawer with buffered closing 2 doors 1 glass shelf 1 top cover 330 mm deep	300	600	828	<b>H B A 5 5 6 A 7 M</b>		
 <p>160 640</p>	<b>Highboard with laundry basket</b> 1 drawer with buffered closing 1 laundry basket with wire basket 1 top cover 330 mm deep  Volume of laundry basket: 25 liters  Volume of laundry basket: 35 liters	300	300	828	<b>H B A 5 5 3 A 7 W</b>		
		300	400	828	<b>H B A 5 5 4 A 7 W</b>		
 <p>160 640</p>	<b>Highboard with laundry basket</b> 1 drawer with buffered closing 1 laundry basket with wire basket 1 top cover 330 mm deep  Volume of laundry basket: 55 liters	300	600	828	<b>H B A 5 5 6 A 7 W</b>		
 <p>160 640</p>	<b>Highboard with laundry pull out</b> 1 drawer with buffered closing 2 doors 1 laundry pull out with wire basket 1 top cover 325 mm deep  Volume of laundry pull out: 40 liters	300	600	828	<b>H B A 5 5 6 A 1 W</b>		

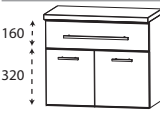

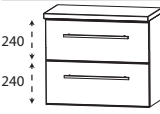
Please observe suitable accessories in the separate index.

# Program 032 - model list

Depth indication corresponds to the carcass depth		Depth in mm	Width in mm	Height in mm	Article number	Hinge	Surcharge high-gloss carcass
<b>Wall units</b>							
	<b>Wall unit</b> 1 door 1 glass shelf 1 top cover 180 mm deep	150	300	668	<b>O G A 4 1 3 A</b>	7 L/R	
		150	400	668	<b>O G A 4 1 4 A</b>	7 L/R	
	Variable in width: please quote the exact dimension of carcass depth. Top cover will be adapted to the cupboard width.	151-300	300	668	<b>O V A 4 1 3 0</b>	L/R	
		151-300	400	668	<b>O V A 4 1 4 0</b>	L/R	
	<b>Wall unit</b> 2 doors 1 glass shelf 1 top cover 180 mm deep	150	600	668	<b>O G A 4 1 6 A</b>	7	
	Variable in width: please quote the exact dimension of carcass depth. Top cover will be adapted to the cupboard width.	151-300	600	668	<b>O V A 4 1 6 0</b>		
	<b>Wall unit</b> 1 flap door, 1 top cover 260 mm deep	230	600	348	<b>O M A 2 1 6 A 7 K</b>		
<b>Base units</b>							
	<b>Base unit</b> 1 drawer with buffered closing 1 door 1 top cover 330 mm deep	300	300	508	<b>U N A 3 2 3 A</b>	7 M L/R	
		300	400	508	<b>U N A 3 2 4 A</b>	7 M L/R	
	<b>Base unit</b> 1 drawer with buffered closing 2 doors 1 top cover 330 mm deep	300	600	508	<b>U N A 3 2 6 A</b>	7 M	
	<b>Base unit</b> 2 pull-outs with buffered closing 1 top cover 330 mm deep	300	300	508	<b>U N A 3 6 3 A</b>	7	
		300	400	508	<b>U N A 3 6 4 A</b>	7	
	<b>Base unit</b> 2 pull-outs with buffered closing 1 top cover 330 mm deep	300	600	508	<b>U N A 3 6 6 A</b>	7	
	<b>Base unit</b> 1 drawer with buffered closing 1 metal pull-out with buffered closing, 1 top cover 330 mm deep	300	300	508	<b>U N A 3 4 3 A</b>	7 M	
		300	400	508	<b>U N A 3 4 4 A</b>	7 M	

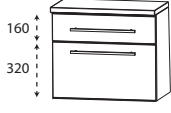

Please observe suitable accessories in the separate index.

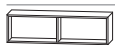
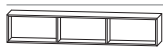
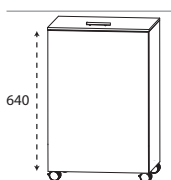
# Program 032 - model list

	Depth in mm	Width in mm	Height in mm	Article number	Hinge	Surcharge high-gloss carcass
Depth indication corresponds to the carcass depth						
<b>Base units</b>						
 <p><b>Base unit</b> 1 drawer with buffered closing 1 metal pull-out with buffered closing, 1 top cover 330 mm deep</p>	300	600	508	<b>UNA346A7M</b>		
 <p><b>Base unit</b> 1 flap door, 1 top cover 260 mm deep</p>	230	600	348	<b>UMA216A7K</b>		
<b>Shelves</b>						
 <p><b>functional shelf</b> Edges are cut with a mitre vertical and horizontal mounting possible</p> <p>please indicate colour version: no. 501 white matt lacquered no. 547 black matt lacquered</p>	150	300	160	<b>RGL113001</b>		
 <p><b>functional shelf</b> Edges are cut with a mitre vertical and horizontal mounting possible</p> <p>please indicate colour version: no. 501 white matt lacquered no. 547 black matt lacquered</p>	150	600	160	<b>RGL116002</b>		
 <p><b>functional shelf</b> Edges are cut with a mitre vertical and horizontal mounting possible</p> <p>please indicate colour version: no. 501 white matt lacquered no. 547 black matt lacquered</p>	150	900	160	<b>RGL119003</b>		
<b>Laundryrolli</b>						
 <p><b>Laundryrolli</b> 1 flap door, with buffered closing 1 take-out laundry-bag, washable 4 roles Colour version corresponds to the carcass colour</p> <p>incl. height indication rolls (100 mm)</p>	470	470	756	<b>WRS4047</b>		



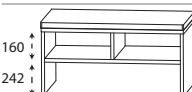

Please observe suitable accessories in the separate index.

# Program 032 - model list

Depth indication corresponds to the carcass depth		Depth in mm	Width in mm	Height in mm	Article number		Hinge	Surcharge high-gloss carcass
<b>Benches</b>								
 <p><b>Bench</b> 1 shelf 1 seat cushion in imitation leather cream-white</p> <p>Colour version corresponds to the carcass colour</p>	450	600	508	<b>S E T B A N K</b>	<b>6</b>			
 <p><b>Bench</b> 2 shelves 1 seat cushion in imitation leather cream-white</p> <p>Colour version corresponds to the carcass colour</p>	450	900	508	<b>S E T B A N K</b>	<b>9</b>			
<b>Push- fit shelf</b>								
 <p><b>Push-fit shelf</b> with ABS thick edge all around incl. holders for push fit shelf</p> <p><b>300 mm wide</b> incl. 2 push-fit holder</p> <p><b>400 mm wide</b> incl. 2 push-fit holder</p> <p><b>600 mm wide</b> incl. 2 push-fit holder</p> <p><b>900 mm wide</b> incl. 3 push-fit holder</p> <p><b>1200 mm wide</b> incl. 3 push-fit holder</p> <p><b>1400 mm wide</b> incl. 3 push-fit holder</p> <p><b>1600 mm wide</b> incl. 4 push-fit holder</p>	150	300	28	<b>S B G 6 0 3 0</b>				
	150	400	28	<b>S B G 6 0 4 0</b>				
	150	600	28	<b>S B G 6 0 6 0</b>				
	150	900	28	<b>S B G 6 0 9 0</b>				
	150	1200	28	<b>S B G 6 0 1 2</b>				
	150	1400	28	<b>S B G 6 0 1 4</b>				
	150	1600	28	<b>S B G 6 0 1 6</b>				

Please observe suitable accessories in the separate index.



# Program 032 - model list

Depth indication corresponds to the carcass depth		Depth in mm	Width in mm	Height in mm	Article number			Hinge	Surcharge high-gloss carcass
<b>Glass shelves</b>									
	<b>Glass shelf</b> incl. metal holder  <b>400 mm wide</b> incl. 2 metal brackets  <b>600 mm wide</b> incl. 2 metal brackets  <b>900 mm wide</b> incl. 3 metal brackets  <b>1200 mm wide</b> incl. 3 metal brackets  <b>1400 mm wide</b> incl. 4 metal brackets	130	400	8	<b>A B G 1 3 4 0 0 8</b>				
		130	600	8	<b>A B G 1 3 6 0 0 8</b>				
		130	900	8	<b>A B G 1 3 9 0 0 8</b>				
		130	1200	8	<b>A B G 1 3 1 2 0 8</b>				
		130	1400	8	<b>A B G 1 3 1 4 0 8</b>				
<b>Accessories</b>									
	<b>Foot, chrome</b> for washbasin base units  Units have to be extra wall-fixed, to avoid fall-overs Price per item	460	40	342	<b>P Z 1 1 2 2 1</b>				
	<b>Foot, chrome</b> for additional cabinets  Units have to be extra wall-fixed, to avoid fall-overs Price per item	290	40	342	<b>P Z 1 1 2 3 1</b>				
	<b>LED lighting frame</b> incl. sensor switcher at the side for units, width: This product contains a light source with energy efficiency class: F  900 mm 8,16 watt / converter 15 watt  1200 mm 9,6 watt / converter 30 watt  1400 mm 10,6 Watt / converter 15 Watt  1600 mm 11,52 watt / Converter 15 watt  to be used between washbasin and base unit not suitable for glass-washbasins  not suitable with Emotion lighting	485	890	16	<b>P Z 1 0 6 1 9 0</b>				
		485	1190	16	<b>P Z 1 0 6 1 1 2</b>				
		485	1390	16	<b>P Z 1 0 6 1 1 4</b>				
		485	1590	16	<b>P Z 1 0 6 1 1 6</b>				

Please observe suitable accessories in the separate index.

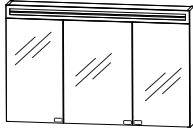

# Program 032 - bathroom variations

STM-0190-2	
1 Mirror cabinet	S 2 A 5 8 9 0 6
1 Washbasin base unit	W U A 3 3 9 0 0 7
1 LED lighting frame	P Z 1 0 6 1 9 0
1 STONEPLUS washbasin, 900 mm	W M E 9 1 9 E 6 1
ST M E 1 9 0 6	SWM 929E 21 evermite
ST G 8 2 9 0 2	WGS 929E 82 glass optwhite inst. cast mineral
ST G 8 3 9 0 2	WGS 929E 83 glass quartzite grey inst. cast mineral

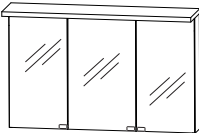

glass washbasins without LED-lighting frame  
900 mm wide

STM-0190-3	
1 Mirror cabinet	S 2 A 4 3 9 0 1 6
1 Washbasin base unit	W U A 3 3 9 0 0 7
1 LED lighting frame	P Z 1 0 6 1 9 0
1 STONEPLUS washbasin, 900 mm	W M E 9 1 9 E 6 1
ST M E 1 9 0 7	SWM 929E 21 evermite
ST G 8 2 9 0 3	WGS 929E 82 glass optwhite inst. cast mineral
ST G 8 3 9 0 3	WGS 929E 83 glass quartzite grey inst. cast mineral



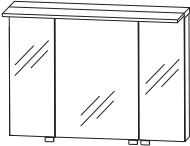

glass washbasins without LED-lighting frame  
900 mm wide

STM-0190-9	
1 Mirror cabinet	S 2 A 4 3 9 0 7 8
1 Washbasin base unit	W U A 3 3 9 0 0 7
1 LED lighting frame	P Z 1 0 6 1 9 0
1 STONEPLUS washbasin, 900 mm	W M E 9 1 9 E 6 1
ST M E 1 9 0 1 0	SWM 929E 21 evermite
ST G 8 2 9 0 9	WGS 929E 82 glass optwhite inst. cast mineral
ST G 8 3 9 0 9	WGS 929E 83 glass quartzite grey inst. cast mineral

glass washbasins without LED-lighting frame  
900 mm wide

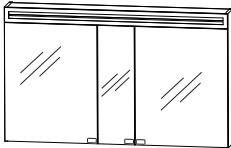
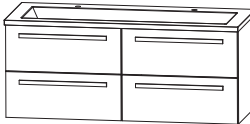
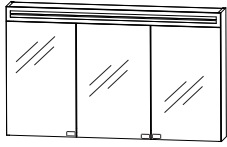
## Program 032 - bathroom variations

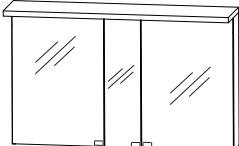
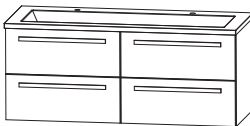
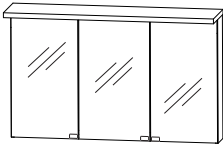
<b>STM-0112-2</b>		
1	Mirror cabinet S 2 A 5 8 1 2 5	
1	Washbasin base unit W U A 3 3 1 2 7	
1	LED lighting frame P Z 1 0 6 1 1 2	
1	STONEPLUS double washbasin, 1200 mm, W M E 9 1 2 D 6 1	1200 mm wide
STME 1126	SWM 922D 21 evermite	
<b>STM-0112-2E</b>		
1	Mirror cabinet S 2 A 5 8 1 2 6	
1	Washbasin base unit W U A 3 3 1 2 0 7	
1	LED lighting frame P Z 1 0 6 1 1 2	
1	STONEPLUS washbasin, 1.200 mm W M E 9 1 2 E 6 1	glass washbasins without LED-lighting frame
STME 1126E	SWM 922E 21 evermite	1200 mm wide
STG 82122E	WGS 922E 82 glass optwhite inst. cast mineral	
STG 83122E	WGS 922E 83 glass quartzite grey inst. cast mineral	
<b>STM-0112-3</b>		
1	Mirror cabinet S 2 A 4 3 1 2 1 5	
1	Washbasin base unit W U A 3 3 1 2 7	
1	LED lighting frame P Z 1 0 6 1 1 2	
1	STONEPLUS double washbasin, 1200 mm, W M E 9 1 2 D 6 1	1200 mm wide
STME 1127	SWM 922D 21 evermite	
<b>STM-0112-3E</b>		
1	Mirror cabinet S 2 A 4 3 1 2 1 6	
1	Washbasin base unit W U A 3 3 1 2 0 7	
1	LED lighting frame P Z 1 0 6 1 1 2	
1	STONEPLUS washbasin, 1.200 mm W M E 9 1 2 E 6 1	glass washbasins without LED-lighting frame
STME 1127E	SWM 922E 21 evermite	1200 mm wide
STG 82123E	WGS 922E 82 glass optwhite inst. cast mineral	
STG 83123E	WGS 922E 83 glass quartzite grey inst. cast mineral	

# Program 032 - bathroom variations

STM-0112-9	
1 Mirror cabinet	S 2 A 4 3 1 2 7 7
1 Washbasin base unit	W U A 3 3 1 2 7
1 LED lighting frame	P Z 1 0 6 1 1 2
1 STONEPLUS double washbasin, 1200 mm,	W M E 9 1 2 D 6 1
ST M E 1 1 2 1 0 SWM 922D 21 evermite	

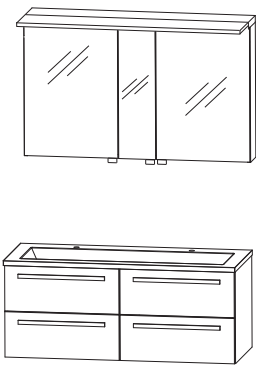

1200 mm wide

STM-0112-9E	
1 Mirror cabinet	S 2 A 4 3 1 2 7 8
1 Washbasin base unit	W U A 3 3 1 2 0 7
1 LED lighting frame	P Z 1 0 6 1 1 2
1 STONEPLUS washbasin, 1.200 mm	W M E 9 1 2 E 6 1
ST M E 1 1 2 E 1 SWM 922E 21 evermite	
ST G 8 2 1 2 9 E WGS 922E 82 glass optwhite inst. cast mineral	
ST G 8 3 1 2 9 E WGS 922E 83 glass quartzite grey inst. cast mineral	

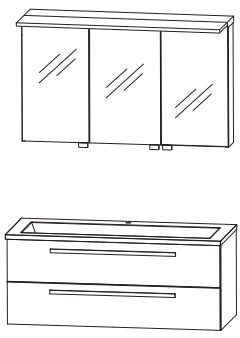

glass washbasins without LED-lighting frame  
1200 mm wide

STM-0114-2	
1 Mirror cabinet, 1400 mm	S 2 A 5 8 1 4 5
1 Washbasin base unit	W U A 3 3 1 4 7
1 LED lighting frame	P Z 1 0 6 1 1 4
1 STONEPLUS double washbasin, 1400 mm	W M E 9 1 4 D 6 1
ST M E 1 1 4 6 SWM 924D 21 evermite	
ST G 8 2 1 4 2 WGS 924D 82 glass optwhite inst. cast mineral	
ST G 8 3 1 4 2 WGS 924D 83 glass quartzite grey inst. cast mineral	

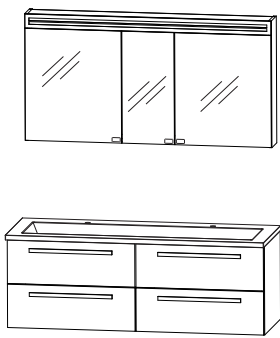

glass washbasins without LED-lighting frame  
1400 mm wide



## Program 032 - bathroom variations

<b>STM-0114-3</b>		
1	Mirror cabinet, 1400 mm	S 2 A 4 3 1 4 1 5
1	Washbasin base unit	W U A 3 3 1 4 7
1	LED lighting frame	P Z 1 0 6 1 1 4
1	STONEPLUS double washbasin, 1400 mm	W M E 9 1 4 D 6 1
S T M E 1 1 4 7		SWM 924D 21 evermite
S T G 8 2 1 4 3		WGS 924D 82 glass optwhite inst. cast mineral
S T G 8 3 1 4 3		WGS 924D 83 glass quartzite grey inst. cast mineral

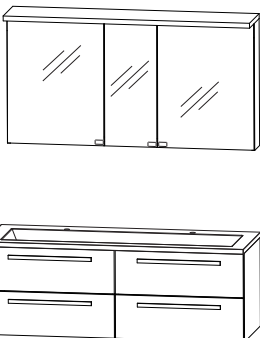

glass washbasins without LED-lighting frame

1400 mm wide

<b>STM-0114-9</b>		
1	Mirror cabinet, 1400 mm	S 2 A 4 3 1 4 7 7
1	Washbasin base unit	W U A 3 3 1 4 7
1	LED lighting frame	P Z 1 0 6 1 1 4
1	STONEPLUS double washbasin, 1400 mm	W M E 9 1 4 D 6 1
S T M E 1 1 4 1 0		SWM 924D 21 evermite
S T G 8 2 1 4 9		WGS 924D 82 glass optwhite inst. cast mineral
S T G 8 3 1 4 9		WGS 924D 83 glass quartzite grey inst. cast mineral

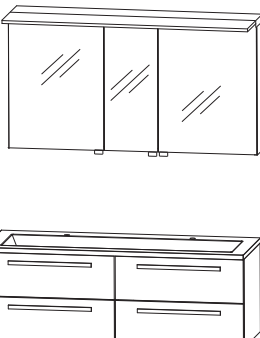

glass washbasins without LED-lighting frame

1400 mm wide

<b>STM-0116-2</b>		
1	Mirror cabinet, 1600 mm	S 2 A 5 8 1 6 5
1	Washbasin base unit	W U A 3 3 1 6 7
1	LED lighting frame	P Z 1 0 6 1 1 6
1	STONEPLUS double washbasin, 1600 mm	W M E 9 1 6 D 6 1
S T M E 1 1 6 6		SWM 926D 21 evermite
S T G 8 2 1 6 2		WGS 926D 82 glass optwhite inst. cast mineral
S T G 8 3 1 6 2		WGS 926D 83 glass quartzite grey inst. cast mineral

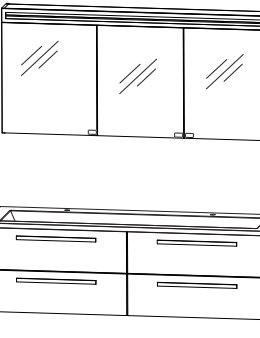

glass washbasins without LED-lighting frame

1600 mm wide

# Program 032 - bathroom variations

STM-0116-3		
1	Mirror cabinet, 1600 mm	S 2 A 4 3 1 6 1 5
1	Washbasin base unit	W U A 3 3 1 6 7
1	LED lighting frame	P Z 1 0 6 1 1 6
1	STONEPLUS double washbasin, 1600 mm	W M E 9 1 6 D 6 1
STME1167	SWM 926D 21 evermite	
STG82163	WGS 926D 81 glass anthracite inst. cast mineral	
STG83163	WGS 926D 83 glass anthracite inst. cast mineral	

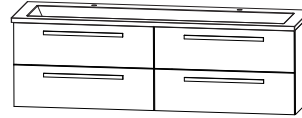
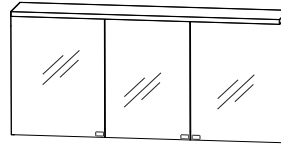

glass washbasins without LED-lighting frame  
1600 mm wide

STM-0116-9		
1	Mirror cabinet, 1600 mm	S 2 A 4 3 1 6 7 7
1	Washbasin base unit	W U A 3 3 1 6 7
1	LED lighting frame	P Z 1 0 6 1 1 6
1	STONEPLUS double washbasin, 1600 mm	W M E 9 1 6 D 6 1
STME11610	SWM 926D 21 evermite	
STG82169	WGS 926D 82 glass optwhite inst. cast mineral	
STG83169	WGS 926D 83 glass quartzite grey inst. cast mineral	

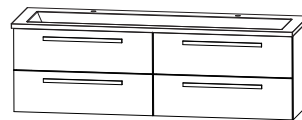
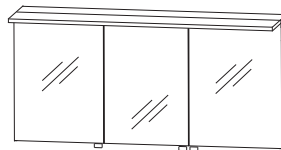

glass washbasins without LED-lighting frame  
1600 mm wide

# Program 032 - dimensional drawings

WME 919E

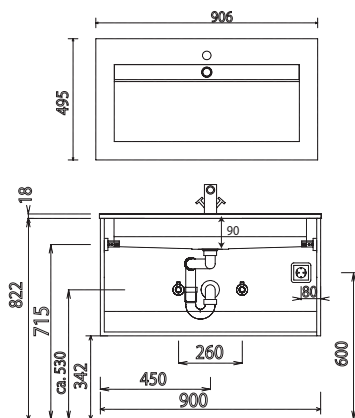

WME 912E

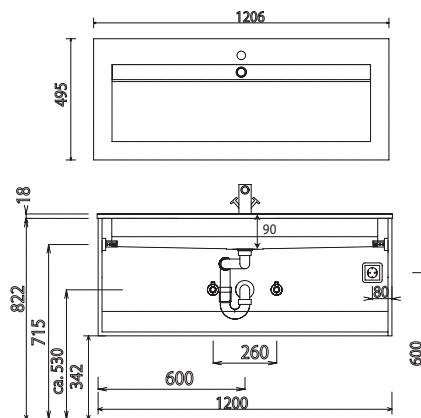

WME 912D

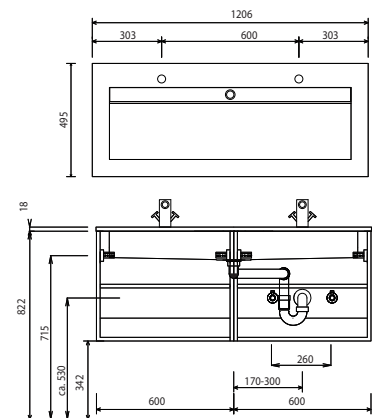

WME 912D

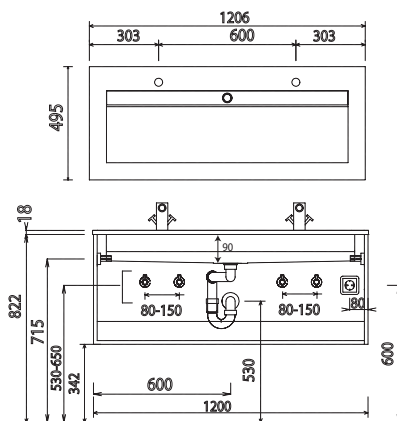

WME 914E

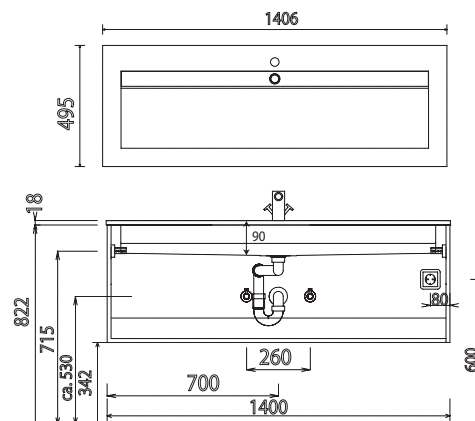

WME 914D

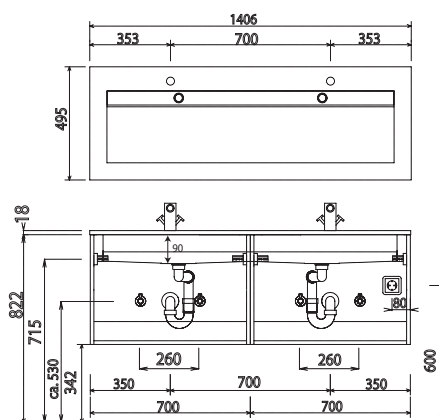

WME 916D

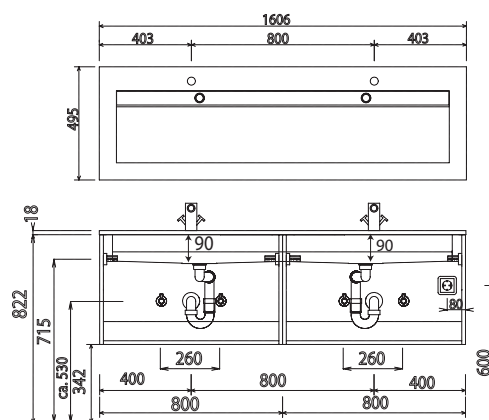

For washing stands with fixing screws, the dimensions for boring must be drawn in on-site after the washing stand has been laid on the floor unit.

**Washing stands without anchoring brackets have to be fixed on the wall and on the furniture-side with silicon!**

evermite / STONEPLUS:

The water temperature must not exceed 55° C / 131° F. Hair tinting lotions have to be removed in a few seconds, so that staining can be avoided.

Modifications:

Technical modifications (+/- 5mm) and flatness modifications (DIN 18202) are subject of the usual material-specific modifications for construction materials, based on DIN 18202.

# Program 032 - dimensional drawings

SWM 929E

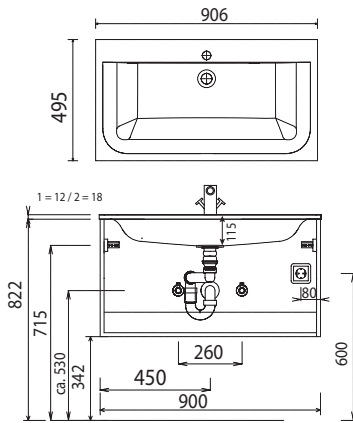

SWM 922E

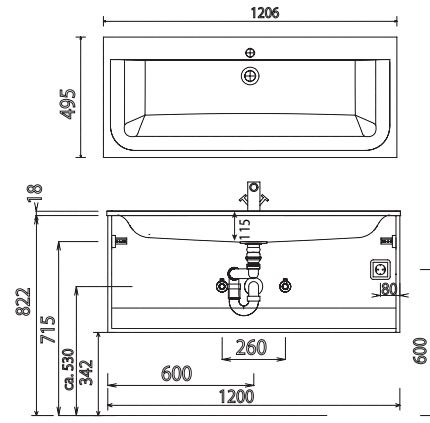

SWM 922D 1

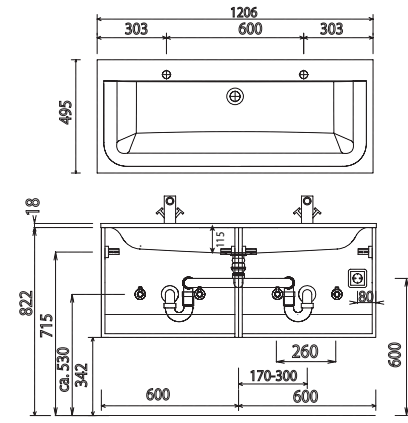

SWM 922D 1

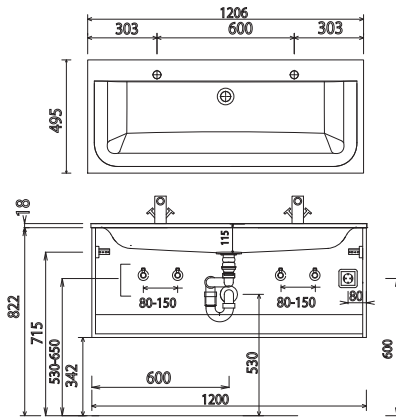

SWM 924E

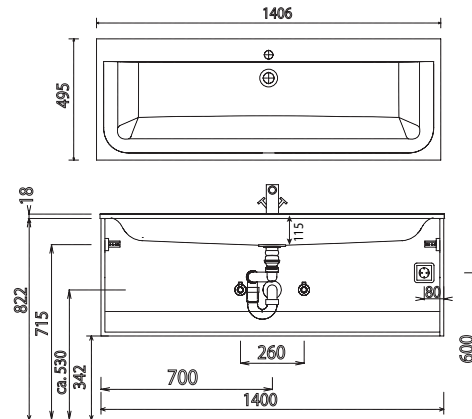

SWM 924D

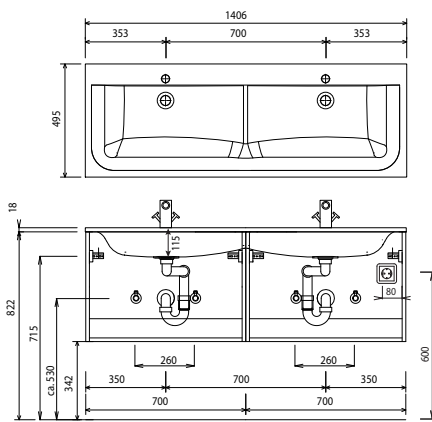

SWM 926D

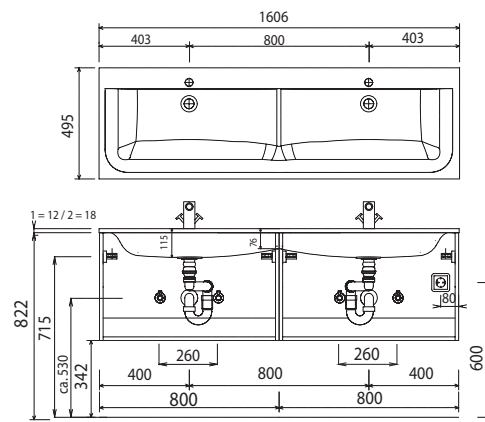

For washing stands with fixing screws, the dimensions for boring must be drawn in on-site after the washing stand has been laid on the floor unit.

**Washing stands without anchoring brackets have to be fixed on the wall and on the furniture-side with silicon!**

evermite / STONEPLUS:

The water temperature must not exceed 55° C / 131° F. Hair tinting lotions have to be removed in a few seconds, so that staining can be avoided.

Modifications:

Technical modifications (+/- 5mm) and flatness modifications (DIN 18202) are subject of the usual material-specific modifications for construction materials, based on DIN 18202.

# Program 032 - dimensional drawings

WGS 929E

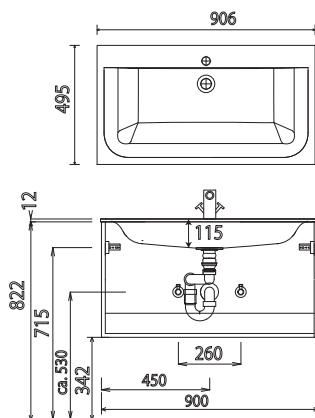

WGS 922E

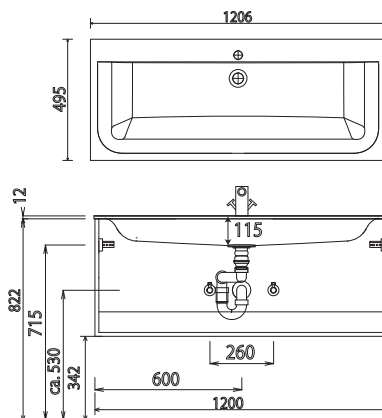

WGS 922D

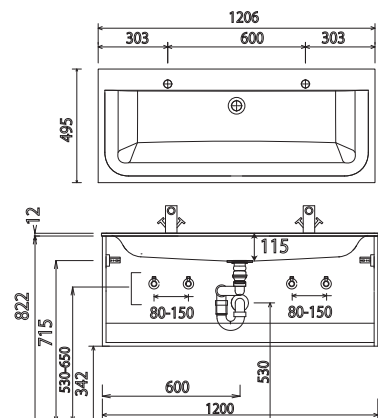

WGS 924D

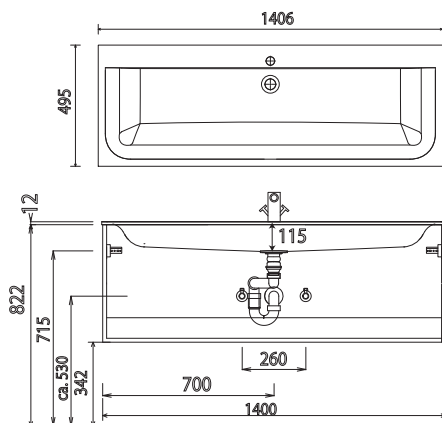

WGS 924D

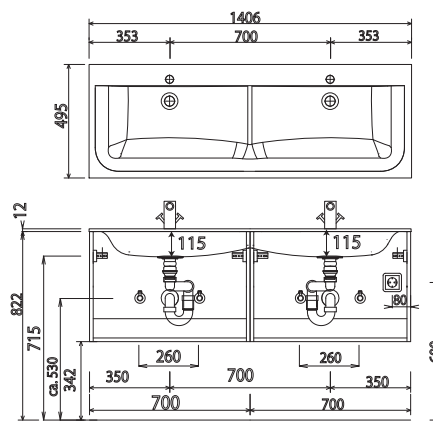

WGS 926D

electrical connections for mirror cabinets

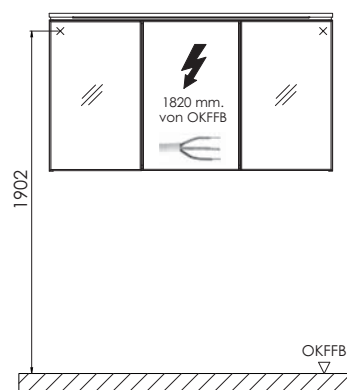
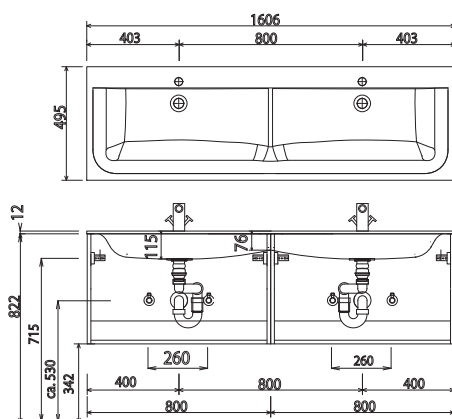

OKFFB=Oberkante Fertigfußboden

For washing stands with fixing screws, the dimensions for boring must be drawn in on-site after the washing stand has been laid on the floor unit.

**Washing stands without anchoring brackets have to be fixed on the wall and on the furniture-side with silicon!**

evermite / STONEPLUS:

The water temperature must not exceed 55° C / 131° F. Hair tinting lotions have to be removed in a few seconds, so that staining can be avoided.

Modifications:

Technical modifications (+/- 5mm) and flatness modifications (DIN 18202) are subject of the usual material-specific modifications for construction materials, based on DIN 18202.