



## Front colours



No. 775 steel grey dark matt



No. 722 polar white hgl.



no. 670 Halifax oak



No. 750 cardiff oak



no. 794 sand oak



No. 679 concrete imitation

**F** foiled front

**M** Melamine coated front with ABS-edge

## Washbasin plates and top covers colours



No. 175 steel grey dark matt



no. 174 Hunton oak



no. 170 Halifax oak



no. 150 cardiff oak



no. 194 sand oak



No. 179 concrete imitation

## carcass colours

\* High gloss carcass for an additional price



No. 175 steel grey dark matt

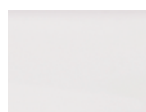

No. 111 white matt

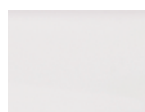

\*no. 161 white hgl.



no. 170 Halifax oak



no. 150 cardiff oak



no. 194 sand oak



No. 179 concrete imitation

## Washbasin colours

Ceramic counter top washbasin

Connect Air



No. 1 white



## Handle versions

handleless - handle profil in carcass colour



No. 324

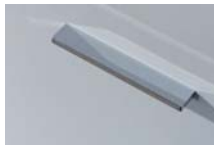

handle bore 128 mm

## Technique

No. 559



Pull outs and drawers



door with integrated buffered closing

Illustrations and specifications are without obligation. Technical modifications reserved.

2021/2022 - ID

Please note the instruction for warranty, mounting and care, and the quality agreements as well, at the beginning of the book.

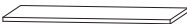
# Program 312 - type list

Depth indication corresponds to the carcass depth		Depth in mm	Width in mm	Height in mm	Article number	Hinge	Surcharge high-gloss carcass
<b>Mirrors</b>							
	<b>Mirror</b> LED lighting vertical 9,4 watt / converter 15 watt incl. toggle switch This product contains a light source with energy efficiency class: F	40	1000	656	<b>F S A 4 3 1 0 1 1</b>		
<b>Ceramic counter top washbasin</b>							
	<b>counter top washbasin Connect Air, white</b> incl. tap hole with overflow trailing edge not glazed  <b>Matching washstand cutout</b>	460	550	100	<b>W T A 0 8 0 5 1</b>  <b>A U S 0 8 0 5 2 8</b>		
<b>washbasin plate</b>							
	<b>washbasin plate</b> <b>Width 1006 mm</b> for 1 cutout central  Please note the additional price for washbasin cutouts.	495	1006	28	<b>A P A 5 0 1 0 5 3</b>		
<b>Washbasin base unit</b>							
	<b>Washbasin base unit</b> 1 drawer with buffered closing with syphon cut- out 1 pull-out with buffered closing  Additional accessories Space-saving drain stench trap DN 40 Space-saving drain stench trap DN 32	470	1000	440	<b>W U A 3 8 1 0 1 G</b>  P Z 1 3 6 7 P Z 1 4 2 3		
handleless							

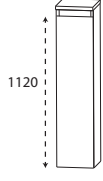
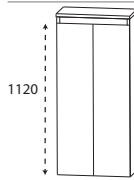
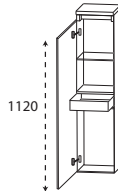
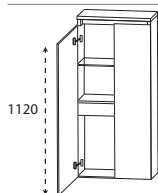
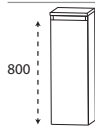

Please observe suitable accessories in the separate index.

# Program 312 - type list

Depth indication corresponds to the carcass depth		Depth in mm	Width in mm	Height in mm	Article number	Hinge	Surcharge high-gloss carcass
<b>Central units</b>							
	<b>medium-high unit</b> 1 door 3 glass shelves 1 top cover 330 mm deep	300	300	1178	<b>M N A 7 1 3 B 1 G</b>	L/R	
handleless							
	<b>medium-high unit</b> 2 doors 3 glass shelves 1 top cover 330 mm deep	300	600	1178	<b>M N A 7 1 6 B 1 G</b>		
handleless							
	<b>medium-high unit with inside drawer</b> 1 door 1 glass shelf (top) 1 inside drawer with buffered closing 1 top cover 330 mm deep	300	300	1178	<b>M N A 7 4 3 B 1 G</b>	L/R	
handleless							
	<b>medium-high unit with inside drawer</b> 2 doors 1 continuous glass shelf 1 consistent inside drawer with buffered closing 1 top cover 330 mm deep	300	600	1178	<b>M N A 7 4 6 B 1 G</b>		
handleless							
<b>Highboards</b>							
	<b>Highboard</b> 1 door 2 glass shelves 1 top cover 330 mm deep	300	300	858	<b>H B A 5 1 3 B 1 G</b>	L/R	
handleless							



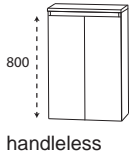
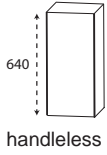
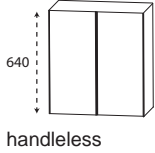
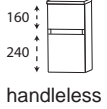

Please observe suitable accessories in the separate index.

# Program 312 - type list

Depth indication corresponds to the carcass depth		Depth in mm	Width in mm	Height in mm	Article number	Hinge	Surcharge high-gloss carcass
<b>Highboards</b>							
 <p>800 handleless</p>	<p><b>Highboard</b> 2 doors 2 glass shelves 1 top cover 330 mm deep</p>	300	600	858	<b>H B A 5 1 6 B 1 G</b>		
<b>Wall units</b>							
 <p>640 handleless</p>	<p><b>Wall unit</b> 1 door 1 glass shelf</p>	150	300	640	<b>O G A 4 1 3 B 1 G</b>	L/R	
 <p>640 handleless</p>	<p><b>Wall unit</b> 2 doors 1 glass shelf</p>	150	600	640	<b>O G A 4 1 6 B 1 G</b>		
<b>Base units</b>							
 <p>160 240 handleless</p>	<p><b>Base unit</b> 1 drawer with buffered closing 1 pull-out with buffered closing 1 top cover 330 mm deep</p>	300	300	468	<b>U N A 3 8 3 B 1 G</b>		
 <p>160 240 handleless</p>	<p><b>Base unit</b> 1 drawer with buffered closing 1 pull-out with buffered closing 1 top cover 330 mm deep</p>	300	600	468	<b>U N A 3 8 6 B 1 G</b>		

Please observe suitable accessories in the separate index.

# Program 312 - type list

Depth indication corresponds to the carcass depth	Depth in mm	Width in mm	Height in mm	Article number			Hinge	Surcharge high-gloss carcass
<b>Benches</b>								
	<b>Bench</b> 1 shelf 1 seat cushion in imitation leather cream-white  Colour version corresponds to the carcass colour	450	600	508	<b>S E T B A N K</b>	<b>6</b>		
	<b>Bench</b> 2 shelves 1 seat cushion in imitation leather cream-white  Colour version corresponds to the carcass colour	450	900	508	<b>S E T B A N K</b>	<b>9</b>		
<b>Glass shelves</b>								
	<b>Glass shelf</b> incl. metal holder  <b>600 mm wide</b> incl. 2 metal brackets  <b>1000 mm wide</b> incl. 3 metal brackets	130	600	8	<b>A B G 1 3 6 0 0 8</b>			
<b>Push-fit shelf</b>								
	<b>Push-fit shelf</b> with ABS thick edge all around incl. holders for push fit shelf  <b>300 mm wide</b> incl. 2 push-fit holder  <b>600 mm wide</b> incl. 2 push-fit holder  <b>1000 mm wide</b> incl. 3 push-fit holder	150	300	28	<b>S B G 6 0 3 0</b>			
Please observe suitable accessories in the separate index.								

# Program 312 - block designation

The numbers represent POINTS not prices

PAB-ZOOM-1

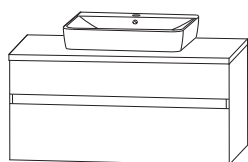
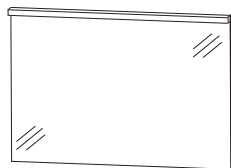

# Program 312 - dimensional drawings

WTA 0805 + WUA 3810 1G

electrical connections for mirror cabinets

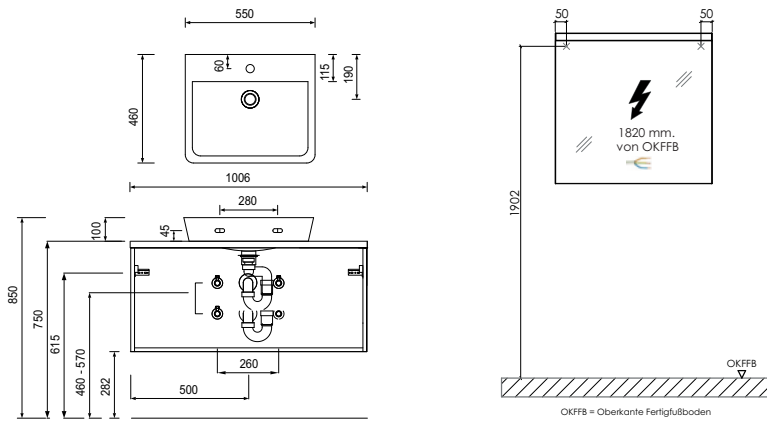

## Modifications:

Technical modifications (+/- 5mm) and flatness modifications (DIN 18202) are subject of the usual material-specific modifications for construction materials, based on DIN 18202.